

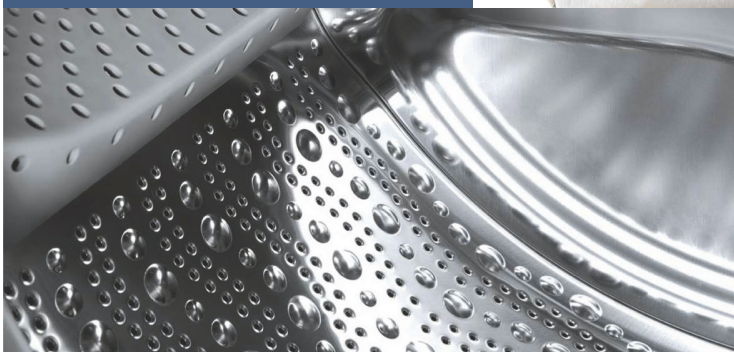

Register your new Bosch now:
www.bosch-home.com/welcome



**Washer dryer
WVH28490AU**



BOSCH

en Instruction Manual and Installation Instructions

Your new washer dryer

You have chosen a Bosch washer dryer.

Please take a few minutes to read and become familiar with the advantages of your washer dryer.

To meet the high quality demands required by Bosch, every washer dryer that leaves our factory is carefully checked to ensure that it functions correctly and is in perfect condition.

For more information on our products, accessories, replacement parts and services, see our website www.bosch-home.com or contact our after-sales service centres.

If the operating and installation instructions describe different models, any differences will be pointed out at the relevant points in the text.



Read these operating and installation instructions before switching on the washer dryer.

Display rules

Warning!

This combination of symbol and signal word indicates a possibly dangerous situation. Not heeding the warning can cause death or injuries.

Caution!

This signal word indicates a possibly dangerous situation. Not heeding the caution can cause property and/or environmental damage.

Note/tip

Information about the optimum use of the appliance/any other useful information.













1. 2. 3. / a) b) c)





The steps are represented by numbers or letters.

■ / -

Lists are represented by a small box or a dash.

Contents

 Intended use	4	 Overview of programmes	20
 Safety instructions	5	Programme on the programme selector	20
Electrical safety	5	Drying table	23
Risk of injury	5	Starching	24
Safety for children	5	Dyeing/Bleaching	24
 Protection of the environment	6	Soaking	24
Packaging/old appliance	6	 Changing programme default settings	24
Hints and tips	6	°C (Temperature)	24
 The main points in brief	7	⌚ (Finish in)	24
 Getting to know your appliance	8	⊖ (Spin speed)	25
Washer dryer	8	☀ (Drying)	25
Control panel	9	 Selecting additional functions	26
Display panel	10	≡⌚ (SpeedPerfect)	26
 Laundry	12	⊖ (EcoPerfect)	26
Preparing laundry for washing	12	🧺 (Rinse plus)	26
Preparing laundry for drying	13	🧻 (Less iron)	26
 Operating the appliance	14	 Setting the signal	27
Preparing the washer dryer	14	 Cleaning and maintenance	28
Selecting the programme/Switching on the appliance	14	Appliance housing/control panel	28
Adjusting the washing programme	14	Drum	28
Adjusting the drying programme	15	Descaling	28
Loading the laundry	16	Cleaning the detergent dispenser	28
Dosing and adding detergent and care product	16	Drain pump blocked	28
Starting the programme	17	Drainage hose on the siphon blocked	29
Childproof lock	18	Filter in the water inlet hose blocked	29
Reloading the laundry	18	Air filter blocked	30
Changing the programme	18	 Faults and what to do about them	30
Interrupting or ending the programme	18	Emergency release, e.g. if a power failure occurs	30
End of the programme	19	Information on the display panel	31
After washing/drying	19	Faults and what to do about them	32

	Customer service	35
	Technical specifications	35
	Consumption values	36
	Installation and connection	37
	Standard accessories	37
	Installation	37
	Secure installation	37
	Installation area	38
	Installing the appliance on a base or on a wooden joist ceiling.	38
	Installing the appliance under/between kitchen units	38
	Removing the transportation protection devices	39
	Hose and cable lengths.	39
	Connecting the water.	40
	Water supply	40
	Water drainage	41
	Drainage into a wash basin	41
	Drainage into a siphon	41
	Drainage into a plastic pipe with rubber sleeve or into a gully	41
	Alignment	42
	Electrical connection	42
	Before washing/drying for the first time.	43
	Transportation	43

Intended use

- For private domestic use only.
- The washer dryer is suitable for washing machine-washable textiles or hand-washable wool in washing water and for drying these textiles.
- The appliance is suitable for operation with cold mains water and commercially available detergents and care products which are suitable for use in a washer dryer.
- Always follow the manufacturer's instructions when dosing all detergents, cleaning aids, cleaning products and cleaning agents.
- The washer dryer may be operated by children from 8 years of age, by persons who have limited physical, sensory or mental abilities and by persons who have inadequate experience or knowledge, provided they **are supervised** or **have been instructed** by a responsible person.
- Children must not perform any cleaning or maintenance work without supervision.
- Keep pets away from the washer dryer.
- Install and operate the washer dryer in a room which has an outflow.

Read and follow the operating and installation instructions and all other information enclosed with the washer dryer.

Retain documents for subsequent use.

Safety instructions

Electrical safety

Warning **Danger of death!**

Danger of death if live parts are touched.

- When disconnecting the mains plug, always pull the plug itself and not the cable, otherwise the cable could be damaged.
- Never touch or hold the mains plug with wet hands.

Risk of injury

Warning **Risk of injury!**

- If the washer dryer is lifted using projecting parts (e.g. the washer dryer door), these components may break off and cause injuries. Do not lift the washer dryer by its projecting parts.
- If you climb onto the washer dryer, the worktop may break and cause injuries. Do not climb onto the washer dryer.
- If you lean/support yourself on the open door, the washer dryer may overturn and cause injuries. Do not lean on the open washer dryer door.
- If you reach into the rotating drum, you may injure your hands. Do not reach into the rotating drum. Wait until the drum stops rotating.

Warning **Risk of scalding!**

- When washing at high temperatures, you may be scalded if you touch the hot washing water (e.g. if draining hot washing water into a washbasin). Do not touch the hot washing water.
- If a drying programme was interrupted, the washer dryer and laundry may be very hot. Select **Intensive Dry** ☀ or **Gentle Dry** ☀ and set the 15 min programme to cool down the laundry and then remove.

Safety for children

Warning **Danger of death!**

If children play on the washer dryer, they may place themselves in life-threatening situations or injure themselves.

- Do not leave children unsupervised near the washer dryer.
- Do not let children play with the washer dryer.

Warning **Danger of death!**

Children may lock themselves inside appliances and suffocate.

On redundant appliances:

- Pull out the mains plug.
- Sever the power cord and discard together with the plug.
- Destroy the lock on the door of the washer dryer.

Warning **Risk of choking!**

When playing, children may become entangled in the packaging/film and packaging parts or pull them over their heads and suffocate.

Keep packaging, plastic film and packaging parts out of the reach of children.

 **Warning**
Risk of poisoning!

Detergents and care products may cause intoxication if consumed or eye/skin irritation if touched. Keep detergents and care products out of the reach of children.

 **Warning**
Eye / skin irritation!

Contact with detergents and care products may cause eye or skin irritation. Keep detergents and care products out of the reach of children.

 **Warning**
Risk of injury!

When washing at high temperatures, the glass part of the door becomes hot. Prevent children from touching the hot door.

 **Protection of the environment**

Packaging/old appliance



Dispose of packaging in an environmentally friendly manner.

This appliance has been identified in accordance with the European Directive 2012/19/EU on Waste Electrical and Electronic Equipment (WEEE). The Directive specifies the framework for an EU-wide valid return and recycling of waste appliances.

Hints and tips

- Utilise the maximum amount of washing for the particular programme.
Overview of programmes
- Wash normally soiled laundry without prewash.
- The selectable temperatures apply to the care labels on the textiles. The temperatures in the machine may deviate from this so that you get the optimum mix of energy-saving and washing results.
- If the laundry is then dried in the appliance, select the maximal possible spin speed. The less water the laundry contains, the less time and energy are required for drying. Do not dry dripping wet laundry.
- Ventilate the installation room well and clean the air inlet filter regularly.
Cleaning and maintenance
→ Page 28
and Installation and connection
→ Page 28

The main points in brief

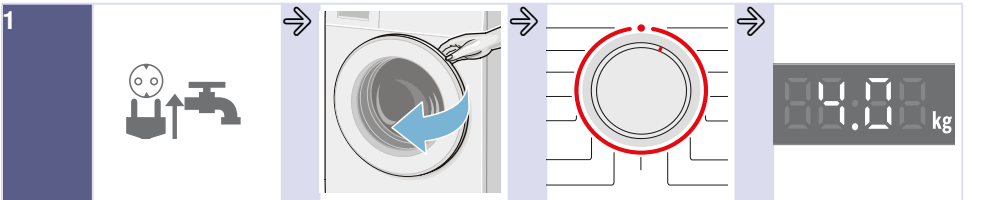

Insert mains plug.
Turn the tap on.

Open the washer
dryer door.

Select the washing/
drying programme

Max. load in display
panel.

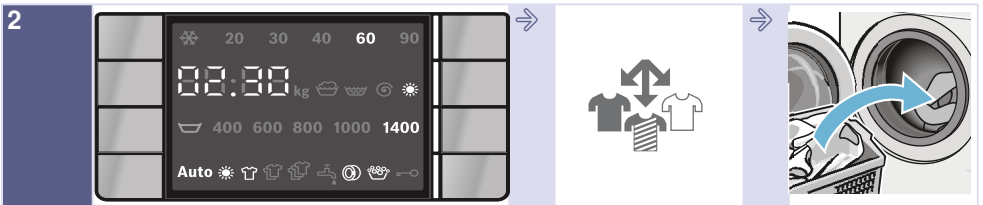

If required, change the programme default
settings and/or select additional functions.

Sort the laundry.

Load the laundry.

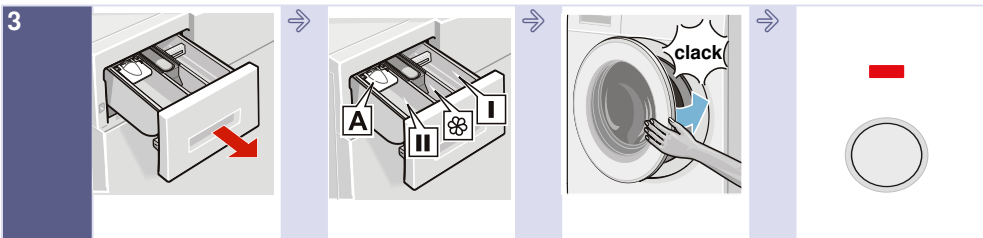

Open the detergent
drawer.

Dose detergent
according to the
dosing
recommendation.
→ Page 16

Close the washer
dryer door.

Select **Start/**
Reload.

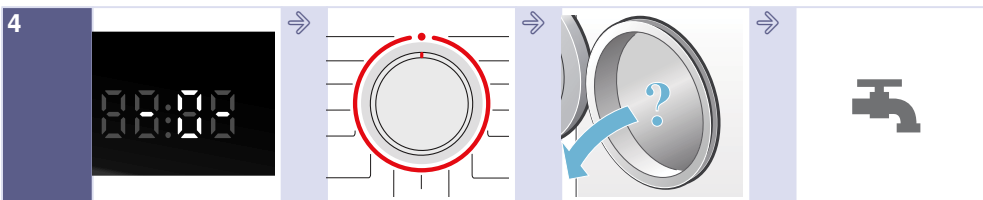

End of the
programme.

Set programme
selector to ● **Off.**

Open the door and
remove the laundry.

Turn off the tap.
(for models without
Aqua-Stop)

Getting to know your appliance

Washer dryer

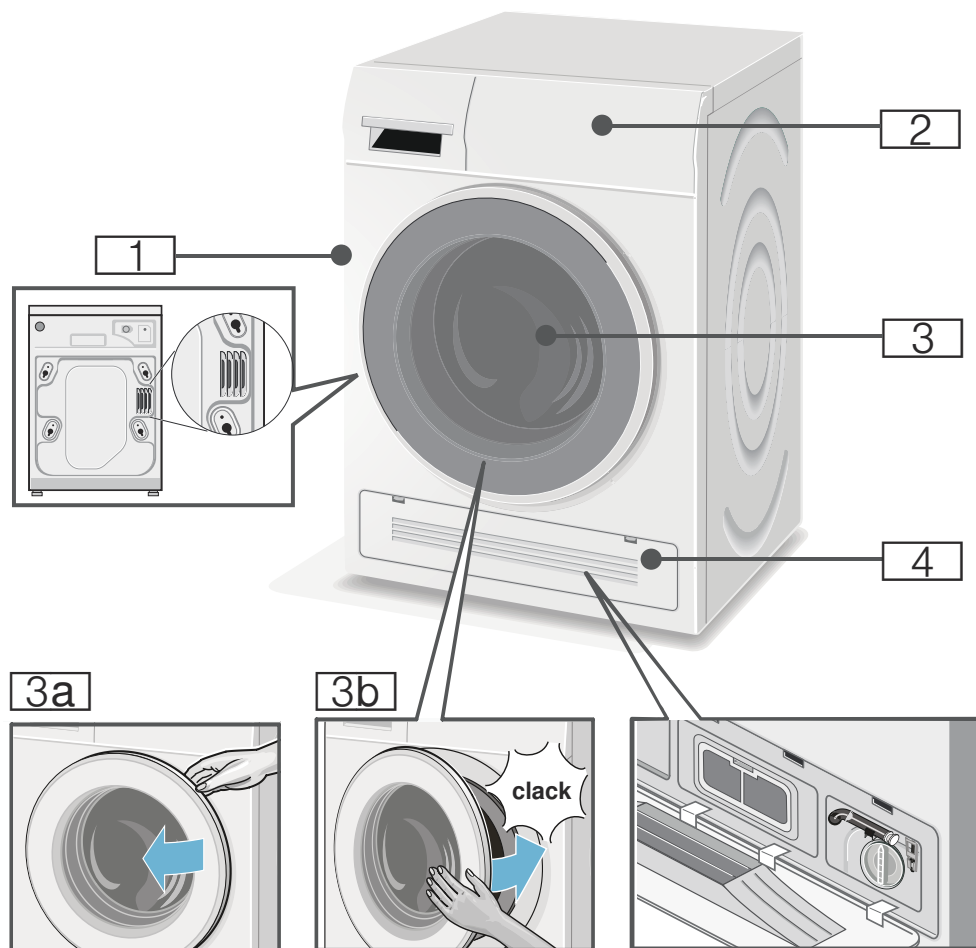

- 1 Hot air outlet
- 2 Operating/display panel
- 3 Door with handle
- 3a Open the door
- 3b Close the door
- 4 Service flap and cool air inlet

Control panel

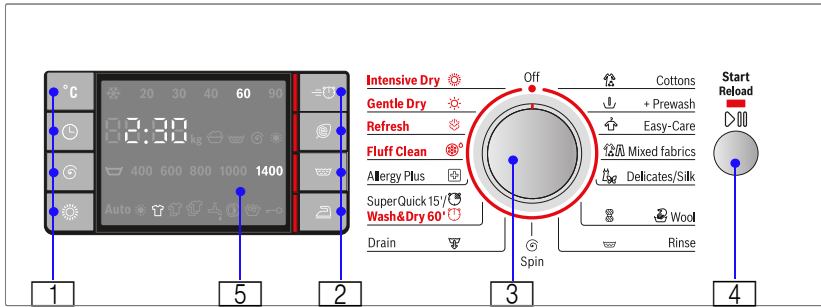

Change the default settings for the selected programme and select additional functions:

1 Select buttons **°C (Temperature)**, **⌚ (Finish in)** time, **🌀 (Spin speed)** and **☀️ (Drying)** for changing default settings → *Page 24*

2 Select buttons **⇌ (speedPerfect)**, **🌿 (ecoPerfect)**, **🚰 (Rinse plus)** and **🧺 (Less iron)** for additional functions → *Page 26*

3 Select a programme. Can be rotated in either direction. To switch off the washer dryer, set programme selector to **● Off**.







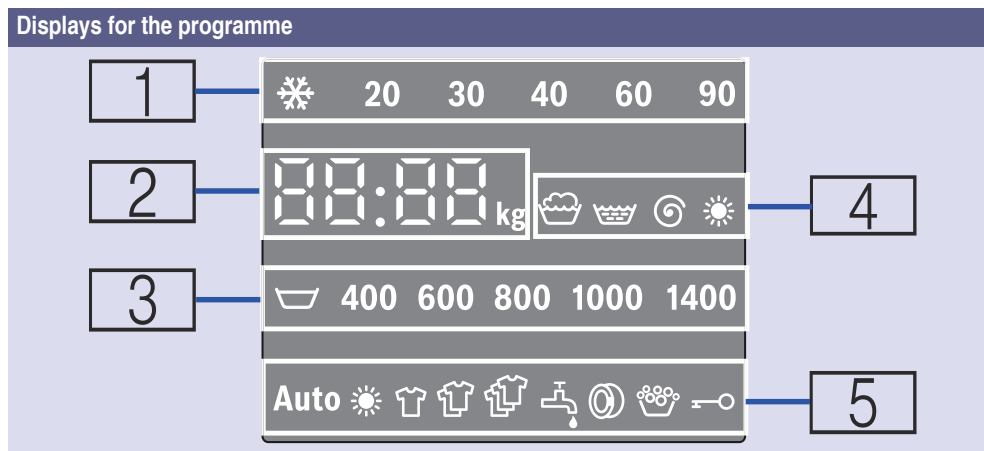













4 Start programme. Select the **Start/Reload** button to start, interrupt (e.g. reload the laundry) and cancel the programme → *Page 18*

5 Display panel for settings and information.

Display panel



1: Temperature for washing programme.	❄ (cold) – 90°C	Temperature in °C
2: Programme information.		
Time:	1:50*	Programme duration after programme selection in h:min (hours:minutes)
	1 – 24 h	Finish in time in h (h=hour)
Capacity:	8.0 kg*	Max. load for selected programmes
Programme status:	– 0 –	Programme end
	PAUS	Programme interrupted
	– – – –	End of programme using Rinse stop
Door open information:	OPEn	The door can be opened if programme interrupted
	A:02	The door cannot be opened
Further information:	E : - - *	Fault display
	0	Setting the signal → <i>Page 27</i>
Drying mode and drying time:	Aut 1	Auto-Dry mode 1, Cupboard dry
	Aut 2	Auto-Dry mode 2, Extra dry
	120*	Selected drying time
	OFF	The drying function is deactivated

3	Spin speed	 - 1400*	Spin speed in revolutions per minute;  (Rinse stop = without final drain/spin cycle, laundry remains in the water after the last rinse cycle)
4	Programme progress symbols		Washing
			Rinsing
			Draining/Spinning
			Drying
5	Programme information symbols	Auto	On if auto drying programme is selected
			On if drying programme is selected.
Automatic load detection function:		  	Detects the load when the water has run in and sets the remaining time accordingly. The symbols indicate a small, medium and large load which was determined by means of the recommended maximum load ** for the selected programme. ** Automatic display of the detected load only for washing programmes with a recommended maximum load of more than 3 kg, with the exception of Spin  , Rinse  and Rinse plus  . Different types of textiles with different degrees of water absorption may influence the load display
Tap	 lights up	Water pressure too low. This extends the programme duration	
	 flashes	The tap has not been turned on or there is no water pressure	
Door	 lights up	When the door can be opened	
	 flashes	When the programme has started: the door is not closed properly	
Overdosage		On if too much foam detected, one rinse cycle switched on	
Childproof lock	 lights up	The childproof lock is activated	
	 flashes	The childproof lock is activated, and if the programme selector has been adjusted or the buttons have been pressed	
* Depends on selected programmes/additional functions.			



Laundry



Preparing laundry for washing



Sorting laundry according to:

Sort your laundry according to the care instructions and specifications of the manufacturer on the care labels:

- Type of fabric/fibre
- Colour
- **Note:** Laundry can discolour or not be cleaned correctly. Wash white and coloured items separately. Wash new bright fabrics separately the first time you wash them.
- Soiling
 - **light**
do not prewash; if necessary select the  (**speedPerfect**) additional function.
 - **normal**
Select programme with prewash. If required, pretreat stains.
 - **heavy**
Load less washing. Select programme with prewash. If required, pretreat stains.
 - **Stains:** Remove/pretreat stains while they are fresh. Firstly, dab with a soap water; do not rub. Then select the appropriate programme and wash the items. Stubborn or dried-in stains can sometimes only be removed by washing several times.

Care label specifications:

-  Suitable for normal washing process;
e.g. Cottons programme
-  A gentle washing process is required;
e.g. Easy-Care programme
-  An especially gentle washing process is required; e.g. Delicates/Silk programme

-  Suitable for washing by hand; e.g.  Wool program
-  Do not machine wash.

Protecting your laundry and washer dryer:

Caution!

Damage to the appliance/textiles

Foreign objects (e.g. coins, paper clips, needles, nails) may damage the washing or components of the washer dryer.

The following instructions must be observed when preparing your laundry:

- Always follow the manufacturer's instructions when dosing all detergents, cleaning aids, care products and cleaning agents.
- Do not exceed maximum load. Overfilling will impair the washing result.
- Keep detergents and agents for the pretreatment of laundry (e.g. stain remover, prewash sprays, etc.) away from the surfaces of the washer dryer. Using a damp cloth, immediately remove any fine spray residue and other residue or droplets.
- Empty any pockets. Remove any foreign objects.

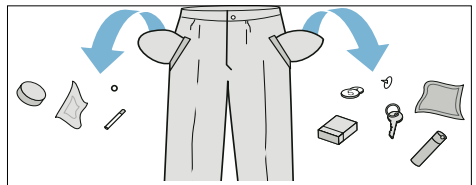

- Remove metal parts (paper clips, etc.).
- Trousers, knitwear and knitted textiles, e.g. jersey garments, T-shirts or sweatshirts, should be turned inside out.
- Ensure that underwired bras are machine-washable.



- Wash delicates in a net or bag (tights, underwired bras, ect).
- Close zips, button up covers.
- Brush sand out of pockets and collars.
- Remove curtain fittings or include in the net/bag.

Preparing laundry for drying

Note: To ensure an even drying result, sort the laundry according to the:

- Type of fabric
- Drying programme
- Care symbols which are indicated on the care labels.

Only dry laundry which is labelled “dryer-proof” or which has the following care symbols:

-  = Dry at normal temperature (**Intensive Dry**)
-  = Dry at low temperature (**Gentle Dry**)

The following textiles must not be dried:

-  = care symbol “Do not dry”
- Wool or textiles containing wool.
- Delicates (silk, synthetic curtains).
- Textiles which contain foam rubber or similar materials.
- Textiles which were treated with flammable liquids, e.g. with stain remover, petroleum ether, thinners. Risk of explosion!
- Textiles which still contain hairspray or similar substances.

Notes

- Before drying, hand-washed textiles must be spun at the appropriate spin speed.
- Before drying, spin at the optimum speed. A spin speed of more than 1000 rpm is recommended for cotton, more than 800 rpm for easy-care textiles.
- Do not iron washing immediately after drying. It is recommended to roll the washing up first to distribute residual moisture evenly.
- To ensure a good drying performance, quilts, terry cloths and other large textiles should be dried separately. Do not dry more than four terry cloths (or 3 kg).
- Do not exceed maximum load.

Operating the appliance

Preparing the washer dryer

The washer dryer was tested before delivery. To remove residual water from the test procedure, the first wash cycle should be run without laundry using the **Fluff clean**  programme. Before washing/drying for the first time

Notes

- Never switch on a damaged washer dryer!
- Inform your customer service!

1. Insert mains plug.
2. Turn the tap on.
The end of the drying programme is followed by an automatic fluff cleaning cycle. The tap must be turned on even when selecting a drying programme.

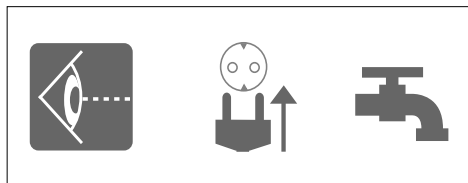

3. Open the door.

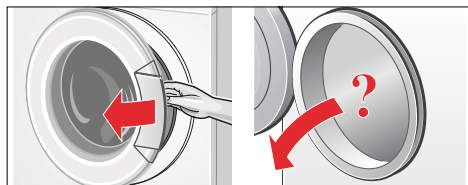

Notes

- Always provide good ventilation in the room where the washer dryer is located so that air produced during the drying phase can be evacuated.
- Always keep the inlets and outlets for the cooling air clear.

Selecting the programme/ Switching on the appliance

Note:

If you have activated the childproof lock, you must deactivate it before you can set a programme.

Select the required programme with the programme selector. Can be rotated in either direction.

The washer dryer is switched on.

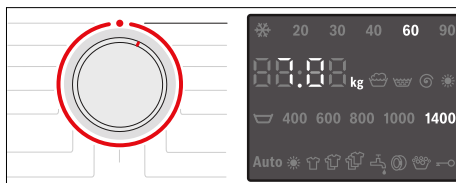

The following figures are indicated continuously on the display panel for the selected programme:

- the programme duration (when door is closed),
- the preset temperature,
- the preset spin speed and
- the maximum load (when door is opened),
- ...

Adjusting the washing programme

You can use the displayed default settings or adjust the selected programme optimally to the laundry items by changing the default settings or selecting additional functions. The selectable settings and additional functions depend on selected washing/drying programme.

Overview of programmes

Notes

- Options can be selected, deselected or changed depending on the progress of the programme.

- The buttons are sensitive, they only need to be touched gently. If the button °C (Temperature), ⌚ (Spin speed), ⌚ (Finish in) is held down, the setting options are automatically scrolled through.

Changing default settings for a washing programme, e. g. washing temperature:

- Touch the °C (Temperature) button to set desired washing temperature.

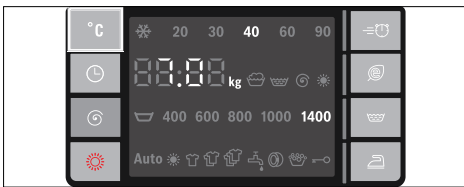

Changing the additional functions for a washing programme, e.g. select SpeedPerfect :

- Touch the SpeedPerfect button; the indicator light comes on and the additional function is selected. To deselect the additional function, touch the SpeedPerfect button again, and the indicator light goes off.

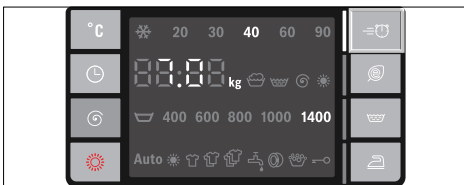

Note:
After changing the programme default settings and/or additional functions, the programme duration may change.

Adjusting the drying programme

Note:

If an individual drying programme or washing and drying without interruption is selected, you can change the default settings for the drying programme if required.

Overview of programmes

Changing the default settings for a drying programme:

- Touch the sun icon (Drying) button to set the desired drying mode or drying time (only for an individual drying programme).



Note:

After changing the default settings for the drying programme, the programme duration may change.

Loading the laundry

Warning **Danger of death!**

Laundry items pretreated with solvent-based detergents, e.g. stain remover/ petroleum ether, may cause an explosion if loaded into the washer dryer.

Thoroughly rinse laundry items by hand before washing.

Notes

- Mix large and small items. Laundry items of different sizes distribute themselves better during the spin cycle. Individual laundry items may cause an unbalanced load.
 - Observe the indicated maximum load. Overfilling adversely affects the washing result and promotes creasing.
1. Unfold presorted laundry items and place in the drum.
 2. Ensure that no laundry items are trapped between the door and rubber seal.

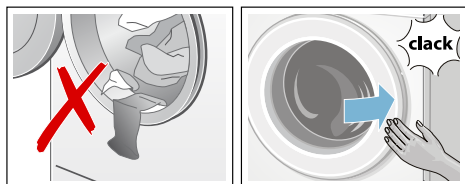

3. Close the door.

Note: The indicator light on the **Start/Reload** button flashes and the default settings for the programme appear continuously on the display panel. Changes may be made to the default settings.

Dosing and adding detergent and care product

Caution! **Damage to the appliance**

Detergents and agents for the pretreatment of laundry (e.g. stain remover, prewash sprays, etc.) may damage the surfaces of the washer dryer.

Keep these agents away from the surfaces of the washer dryer. Using a damp cloth, immediately remove any fine spray residue and other residue/droplets.

Dosing

Dose the detergents and care products according to:

- water hardness (ask your water supply company),
- the manufacturer's specifications on the packaging,
- the amount of laundry,
- soiling.

Filling the dispensers

1. Pull out the detergent drawer.

Warning **Eye / skin irritation!**

If the detergent drawer is opened while the appliance is running, detergent/care product may run out. Carefully open the drawer.

If detergent/care product comes into contact with eyes or skin, rinse thoroughly.

If accidentally swallowed, seek medical advice.

2. Pour in detergent and/or cleaning product.

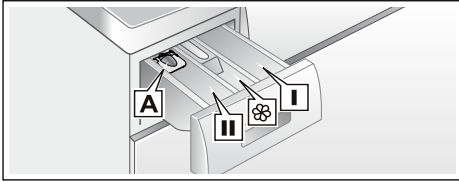

- Dispenser **I** Detergent for prewash.
 Dispenser  Softener, starch. Do not exceed the maximum load.
 Dispenser **II** Detergent for main wash, water softener, bleach, stain remover.
 Dispenser **A** For dosing liquid detergent.

Notes

- Always follow the manufacturer's instructions when dosing all detergents, cleaning aids, care products and cleaning agents.
- Dilute viscous fabric softener and fabric conditioner with water. This will prevent blockages.
- Be careful when opening the detergent drawer while the appliance is running.
- If an individual drying programme is selected, please do not add detergent and/or care product in the appliance.

Measuring aid* for liquid detergent

*depending on the model

Position the measuring aid for measuring the correct amount of liquid detergent:

1. Pull out the detergent drawer. Press down the insert and fully remove the drawer.
2. Slide the measuring aid forwards, fold it down and click it into place.
3. Reinsert the drawer.

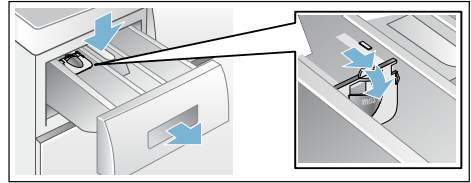

Note: Do not use the measuring aid for gel detergents and washing powder, or for programmes with prewash or when "Finish in" time is selected.

For models without a measuring aid, pour the liquid detergent into the appropriate dispenser and place it in the drum.

Starting the programme

Touch the **Start/Reload** button. The indicator lamp is lit and the programme starts.



Note: If you want to secure the programme to prevent it from being adjusted inadvertently, select the childproof lock.



The display panel shows the Finished in time while the programme is running or the programme duration and the programme progress symbols when the washing programme has started.

Display panel → *Page 10*

Childproof lock

You can secure the washer dryer to prevent the set functions from being changed inadvertently. To do this, activate the childproof lock when the programme has started.

Activating/deactivating: Touch and hold the button  (**Finish in**) for approx. 5 seconds. The symbol  is indicated in the display. If the button signal is activated, an acoustic signal sounds.

-  lights up: The childproof lock is activated.
-  flashes: The childproof lock is active and the programme selector has been adjusted. To prevent the programme from terminating, reset the programme selector to the initial programme. The symbol lights up again.

Note:



The childproof lock may remain activated until the next programme starts, even after the washer dryer has been switched off. If this is the case, deactivate the childproof lock before the programme starts and, if required, re-activate after the programme starts.

Reloading the laundry

When the programme has started, the laundry can be reloaded or taken out as required.



Select **Start/Reload** . The washer dryer checks whether a reloading is possible.

Notes

- If there is a high water level, high temperature or if the drum is rotating, the door remains locked for safety reasons and reloading is not possible.
If the following is indicated on the display panel:
A:02 + PAUS → Reloading is not possible. To continue the programme, select the **Start/Reload**  button.
 + **OPEn** are lit → Reloading is possible.
- Do not open the door until **both** the symbols  + **OPEn** are lit.
- Do not leave door open for a prolonged period – water could run out of the laundry.
- The reloading function cannot be activated during the drying phase.



Changing the programme

If you have started the wrong programme by mistake, you can change the programme as follows:



1. Select **Start/Reload** .
2. Select another programme. If required, adjust the default settings and/or select other additional functions.
3. Select **Start/Reload** . The new programme starts from the beginning.

Interrupting or ending the programme

For programmes at high temperature:

1. Select **Start/Reload** .
2. To cool down laundry: Select **Rinse** .
3. Select **Start/Reload** .

For programmes at low temperature:

1. Select **Start/Reload** .
2. Select **Drain**  or **Spin** .
3. Select **Start/Reload** .

For drying programmes:

1. Select **Intensive Dry** ☀ or **Gentle Dry** ☀.
2. Touch button ☀ (**Drying**) and set drying time to 15 minutes.
3. Select **Start/Reload** ▷|||.

End of the programme

– 0 – or – – – – (**Rinse stop** = without final drain/spin cycle) is indicated in the display and acoustic signal sounds.

Setting the signal → Page 27

If ☹ (**Rinse stop** = without final drain/spin cycle) was selected, press **Start/Reload** button to start the final drain/spin cycle.

Notes

- The programme continues by pumping out the water and spinning the laundry (the standard spin speed can be changed beforehand).
- If only the water is to be pumped out, approx. 1 minute after the programme starts, touch the ▷||| (**Start/Reload**) button before the spin cycle starts, then turn the programme selector to ● **Off**. The programme is interrupted and the door lock is released. The laundry can be removed.
- If **hot** flashes in the display before the drying programme ends, the temperature in the drum is high. The programme for cooling the drum runs until the temperature in the drum has dropped.

After washing/drying

1. Open the door and remove the laundry.
2. Turn the programme selector to ● **Off**. The appliance is switched off.
3. Turn off the tap.
Not required for Aqua-Stop models.

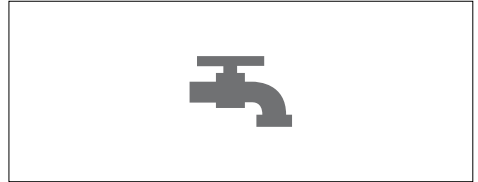

Notes



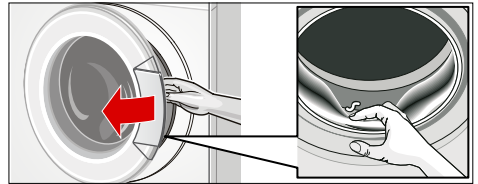











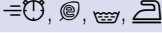

- Do not leave any items of laundry in the drum. In the next wash they may shrink or discolour another item.
- Remove any foreign objects from the drum and the rubber seal – risk of rust.

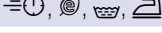



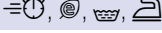



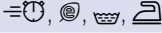



























- Leave the detergent drawer and door open so that residual water can evaporate.
- Always remove the laundry.
- Always wait until the programme ends, as the appliance could still be locked. Then switch the appliance on and wait for the unlocking device.
- When the display panel has gone out at the end of the programme, energy-saving mode is active. To activate, select any button.

Overview of programmes

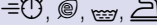
Programme on the programme selector

Programme/Type of washing	Options/Information
<p>Name of the programme</p> <p>Brief explanation of the programme and which textiles it is suitable for.</p>	<p>maximum load according to EN50229</p> <p>maximum load for washing/ maximum load for drying</p> <p>selectable temperature in °C</p> <p>selectable spin speeds in rpm</p> <p>possible additional functions for washing</p> <p>possible settings for drying</p>
<p>Cottons </p> <p>Hard-wearing textiles, heat-resistant textiles made of cotton or linen.</p> <p>Note: * Reduced load for  additional function.</p>	<p>max. 8(4)* kg/4 kg</p> <p> (cold) – 90 °C</p> <p> – 1400 rpm</p> <p></p> <p>Aut 1, Aut 2</p>
<p>+ Prewash </p> <p>Energy-intensive program for heavily soiled hard-wearing textiles made of cotton or linen.</p> <p>Note: * Reduced load for  additional function.</p>	<p>max. 8(4)* kg/4 kg</p> <p> (cold) – 90 °C</p> <p> – 1400 rpm</p> <p></p> <p>Aut 1, Aut 2</p>
<p>Easy-Care </p> <p>Easy-Care textiles made of cotton, linen, synthetic fibres or blended fabrics.</p>	<p>max. 3.5 kg/2.5 kg</p> <p> (cold) – 60 °C</p> <p> – 1000 rpm</p> <p></p> <p>Aut 1, Aut 2</p>
<p>Mixed fabrics </p> <p>Mixed load consisting of textiles made of cotton and synthetics.</p>	<p>max. 3.5 kg/2.5 kg</p> <p> (cold) – 60 °C</p> <p> – 1400 rpm</p> <p></p> <p>Aut 1, Aut 2</p>

Programme/Type of washing	Options/Information
<p>Delicates/Silk </p> <p>For delicate, washable textiles, e.g. made of silk, satin, synthetic fibres or blended fabrics.</p>	<p>max. 2 kg</p> <p> (cold) – 40 °C</p> <p> – 800 rpm</p> <p>, , , </p> <p>–</p>
<p>Wool </p> <p>Hand and machine-washable fabrics made of wool or that contain wool; particularly gentle wash programme to prevent shrinkage of laundry, with longer programme breaks (fabrics rest in the detergent solution).</p> <p>Note: Wool is of animal origin, e.g.: Angora, alpaca, llama, sheep. Use a detergent which is suitable for machine washing wool.</p>	<p>max. 2 kg</p> <p> (cold) – 40 °C</p> <p> – 800 rpm</p> <p>–</p> <p>–</p>
<p>Rinse </p> <p>Washable textiles, Extra rinse with spin.</p>	<p>max. 8 kg</p> <p>–</p> <p> – 1400 rpm</p> <p>, </p> <p>–</p>
<p>Spin </p> <p>Extra spin with selectable spin speed.</p>	<p>max. 8 kg</p> <p>–</p> <p>400 – 1400 rpm</p> <p>, </p> <p>–</p>
<p>Drain </p> <p>Draining of the water inside the drum, e.g. after rinse stop .</p>	<p>max. 8 kg</p> <p>–</p> <p>–</p> <p>–</p> <p>–</p>
<p>SuperQuick 15' /Wash&Dry 60' </p> <p>Easy-Care textiles made of cotton, linen, synthetic or blended fabrics; short programme, approx. 15 min, suitable for lightly soiled laundry..</p>	<p>max. 3.5(2.0)* kg/1 kg</p> <p> (cold) – 40 °C</p> <p> – 1000 rpm</p> <p>, </p> <p>Aut 1</p>

Programme/Type of washing	Options/Information
<p>Allergy Plus </p> <p>Hard-wearing textiles made of cotton or linen, for particularly sensitive skin, longer wash cycle at the selected temperature, more water, extra rinsing.</p> <p>Note: * Reduced load for  additional function.</p>	<p>max. 7(4)* kg/4 kg</p> <p> (cold) – 60 °C</p> <p> – 1400 rpm</p> <p></p> <p>Aut 1, Aut 2</p>
<p>Fluff Clean </p> <p>Special program for drum hygiene or fluff removal.</p> <p>90 °C = antibacterial program, do not use detergent.</p> <p>40 °C = antibacterial program; special drum cleaning detergent can be used.</p> <p> (cold) = rinsing programme for the removal of fluff which has collected in the washer drum during the drying phase.</p>	<p>–</p> <p> (cold) , 40, 90 °C</p> <p>400 – 1400 rpm</p> <p>–</p> <p>–</p>
<p>Refresh </p> <p>Odour removal and wrinkle reduction program, suitable for wool, linen, suits, etc. which do not need frequent washing.</p>	<p>max. 1 kg</p> <p>–</p> <p>–</p> <p>–</p> <p>–</p>
<p>Gentle Dry </p> <p>Easy-Care textiles, drying at low temperature.</p> <p>Note: ** 15 min programme is for cooling down the laundry after drying programmes.</p>	<p>max. 2.5 kg</p> <p>–</p> <p>–</p> <p>–</p> <p>Aut 1, Aut 2, Time dry**</p>
<p>Intensive Dry </p> <p>Cotton/coloureds, drying at normal temperature.</p> <p>Note: ** 15 min programme is for cooling down the laundry after drying programmes.</p>	<p>max. 4 kg</p> <p>–</p> <p>–</p> <p>–</p> <p>Aut 1, Aut 2, Time dry**</p>

Drying table

Cottons/coloureds (textiles made of cotton or linen such as underwear, T-shirts, sweaters, trousers, kitchen towels)									
Dry weight in kg		0,5 ~ 1,0	1,0 ~ 2,0	2,0 ~ 3,0	3,0 ~ 4,0	~ 0,5	~ 1,0	~ 2,0	~ 2,5
Estimated drying time in min					Adjustable drying time in min				
Cup-board dry	Aut1	<60	60 ~ 85	85 ~ 120	120 ~ 160	30	60	90	120
Extra dry	Aut2	<65	65 ~ 100	100 ~ 140	140 ~ 170				
Recommended programme		Intensive Dry ☀️ (Auto)				Intensive Dry ☀️ (Time)			
Quilt/terry cloth (larger or thick textiles made of cotton such as terry cloths, bed sheets, table cloths, jeans, work clothes)									
Dry weight in kg		0,5 ~ 1,0	1,0 ~ 2,0	2,0 ~ 3,0	3,0 ~ 4,0	~ 0,5	~ 1,0	~ 1,5	~ 2,0
Estimated drying time in min					Adjustable drying time in min				
Cup-board dry	Aut1	<70	70 ~ 95	95 ~ 130	130 ~ 170	30	60	90	120
Extra dry	Aut2	<75	75 ~ 110	110 ~ 150	150 ~ 180				
Recommended programme		Intensive Dry ☀️ (Auto)				Intensive Dry ☀️ (Time)			
Easy-care (Textiles made of synthetic or blended fabrics such as shirts, sportswear, delicate items)									
Dry weight in kg		0,5 ~ 1,0	1,0 ~ 2,0	2,0 ~ 2,5		~ 0,5	~ 1,0	~ 1,5	~ 2,0
Estimated drying time in min					Adjustable drying time in min				
Cup-board dry	Aut1	<55	55 ~ 95	95 ~ 130		30	60	90	120
Extra dry	Aut2	<65	65 ~ 130	130 ~ 160					
Recommended programme		Gentle Dry ☀️ (Auto)				Gentle Dry ☀️ (Time)			
i	The times are approximate and refer to a normal load, standard spin programme and room temperature.								
i	The maximum selectable drying time is 120 min. If the laundry weighs more than 2.5 kg, select automatic drying. This function is recommended to ensure good drying results and save energy. The 15-minute drying programme is used to cool the laundry.								

Starching



Note: The laundry should not be treated with fabric softener.

Liquid starch can be used in all wash programmes. Pour starch into the dispenser  according to manufacturer's specifications (if required, clean beforehand).

Dyeing/Bleaching

Dye in household quantities only. Salt may attack stainless steel! Observe specifications of the dye manufacturer! **Do not** bleach laundry in the washer dryer!

Soaking

1. Pour soaking agent/detergent into dispenser **II** according to the manufacturer's instructions.
2. Set the programme selector to **Cottons 60°C** and select **Start/Reload** .
3. After approximately 10 minutes select **Start/Reload** .
4. After the required soaking time, reselect **Start/Reload**  if the programme is to be continued or change the programme.

Note:

Load laundry of the same colour. No additional detergent is required, the soaking solution is used for washing.

P+ Changing programme default settings

You can change the default settings for selected programmes. The settings can be changed even while the selected programme is running. The effects depend on the progress of the programme.



°C (Temperature)

[1]: The indicated washing temperature can be changed. The maximum selectable washing temperature varies depending on the selected programme.

Overview of programmes

(Finish in)

[2]: Delays the Finish in time (end of programme).



Note:

The respective programme duration is displayed by selecting the programme. The programme duration is automatically adjusted while the programme is running if the programme duration needs to be changed, e.g. due to changes in the programme default settings.



Before the programme starts, the end of the programme can be preselected in hourly increments up to a maximum of **24h**.

When the programme has started, the preselected time is displayed e.g. **8:00h** and counts down until the programme starts. Then the programme duration is displayed, e.g. **2:30h**

When the programme has started, the preselected time can be changed as follows:

1. Select **Start/Reload** .
2. Select the  (**Finish in**) button and change the Finish in time.
3. Select **Start/Reload** .

(Spin speed)

: The spin speed can be changed before and during the programme (in rpm, revolutions per minute) depending on the progress of the programme. Setting  (**Rinse stop** = without final drain/spin cycle), laundry remains in the water after the last rinse cycle. The maximum spin speed depends on the programme and model.

Overview of programmes

(Drying)

: The drying function can be activated, deactivated and set with this button. Washing and drying without interruption is possible in automatic mode only. If the programme for individual drying is selected, automatic drying or timed drying with a required drying duration is available.

Notes

- Programme selection in **Intensive Dry**  or **Gentle Dry**  position to select an individual drying programme.
Overview of programmes
The standard drying mode is **Aut1**. In this mode the drying time is automatically set according to the amount of laundry to be dried. The result is cupboard-dry laundry. Drying mode can be set to **Aut2** in order to obtain an extra dry result; or preselect the drying time which can be specified by selecting the  (**Drying**) button.
Cupboard dry (Aut1): For single-layer fabrics. Garments can be folded or hung up in a cupboard.
Extra dry (Aut2): For fabrics made of thick, multilayered items of clothing, which need to be dried longer. Garments can be folded or hung up in a cupboard. Laundry more dry than Cupboard dry.
- Programme selection in washing programmes and if washing and drying is required without interruption (only for **Cottons** , **+Prewash** , **Easy-Care** , **Mixed fabrics** , **SuperQuick 15'**  and **Allergy Plus** ).
1. Touch button  (**Drying**) and activate the function **Aut1** or **Aut2**.
2. Do not exceed the maximum loads for drying.
Overview of programmes
3. Maximum spin speed for the washing programme will be selected automatically to obtain a good drying result.

P+ Selecting additional functions

You can select your desired additional functions by touching the respective buttons.



(SpeedPerfect)

1 For a shorter wash time with a comparable washing result to the standard programme.

Note: Do not exceed maximum load.
Overview of programmes

(EcoPerfect)

2: Energy-optimised washing by reducing the temperature while achieving a consistent washing result.

Note: The washing temperature is lower than the selected temperature. For special hygiene requirements, the **Allergy+**  programme is recommended.

(Rinse plus)

3: Additional rinse cycle. For areas with very soft water or for an even better rinsing result.

(Less iron)

4 Special spin sequence with subsequent fluffing. Gentle final spin – residual moisture in the laundry increased slightly.

Setting the signal

1. Activate setting mode for the signal volume

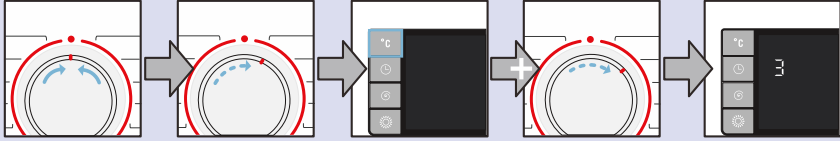

Turn to ● **Off**.

Turn one position clockwise.

Press and hold the °C button + turn one position clockwise.

Release the button.

2.a Set the volume for the button signals (depending on model)

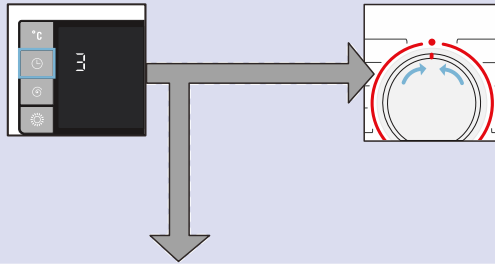

Press the ⏪ button until the required volume is reached.

Go to step 2.b or

Set to ● **Off**, which exits setting mode for the signal volume.

2.b Selecting the volume for the information signals

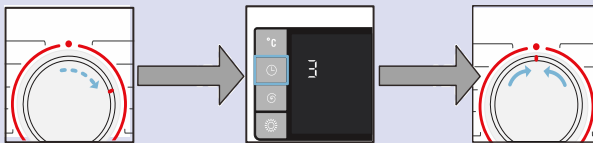

Turn one position clockwise

Press the ⏪ button until the required volume is reached.

Set to ● **Off**, which exits setting mode for the signal volume.



Cleaning and maintenance

Warning

Risk of electric shock!

Danger of death if live parts are touched.
Switch off the appliance and disconnect at the mains plug.

Warning

Risk of poisoning!

Solvent-based cleaning agents, e.g. petroleum ether, in the washer dryer may cause toxic vapours.
Do not use solvent-based cleaning agents.

Caution!

Damage to the appliance

Solvent-based cleaning agents, e.g. petroleum ether, may damage the surfaces and components of the washer dryer.
Do not use solvent-based cleaning agents.

Appliance housing/control panel

- Remove the detergent residue immediately.
- Wipe the housing and the control panel with a soft, damp cloth.
- Do not use abrasive cloths, sponges or detergents (stainless steel cleaner).
- Do not clean the appliance with a water jet.

Drum

Use chlorine-free cleaning agents, do not use steel wool.

1. Turn the tap off to prevent more water from flowing in and to ensure

Descaling

Not required if detergent dosed correctly. However, if this does occur, follow the instructions of the descaling agent manufacturer. Suitable descalers can be purchased on our website or from customer service.

Cleaning the detergent dispenser

If it contains detergent or fabric softener residue:

1. Pull out the detergent drawer. Depress the insert and remove the drawer completely.
2. Take out insert: using your finger, press insert upwards.

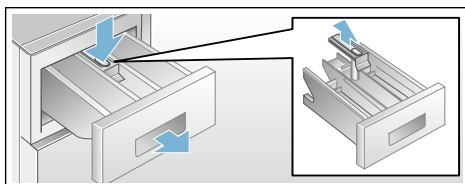

3. Clean the detergent dispenser and insert with water and a brush and dry.
4. Attach the insert and lock into position (push the cylinder onto the guide pin).
5. Insert detergent drawer.

Note: Leave the detergent drawer open so that residual water can evaporate.

Drain pump blocked

Warning

Risk of scalding!

Washing water is hot when washing at high temperatures. You may be scalded if you touch the hot washing water.
Allow the washing water to cool down.

that it is drained via the detergent solution pump.

2. Turn the programme selector to ● **Off**. Pull out the mains plug.
3. Open the service flap.
4. Take the drainage hose out of the holder.

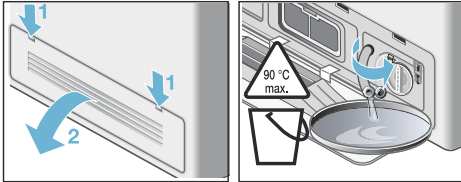

5. Remove the cover flap, draining the washing water into a suitable container. Press on the cover flap and insert the drainage hose into the holder.

Note: Residual water may run out.

6. Carefully unscrew the pump cover. Clean the interior, pump cover thread and pump housing (the fan impeller in the detergent-solution pump must be able to rotate).
7. Reinsert and screw on the pump cover. Handle should be vertical.

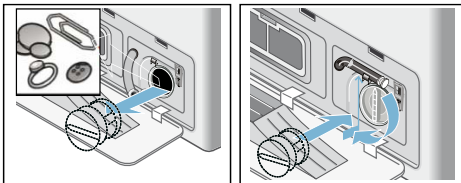

8. Close the service flap. If required, engage the disengaged service flap beforehand.

Note: To prevent unused detergent from flowing into the outlet during the next wash: Pour 1 litre of water into dispenser **II** and start the **Spin** Ⓢ or **Drain** Ⓣ.

Drainage hose on the siphon blocked

1. Turn the programme selector to ● **Off**. Pull out the mains plug.

2. Loosen hose clip, carefully remove drainage hose. Residual water may run out.
3. Clean drainage hose and siphon spigot.

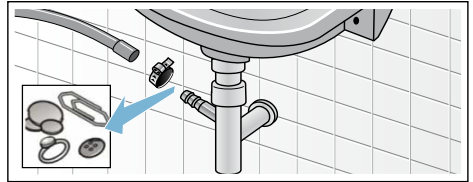

4. Re-attach the drainage hose and secure the connection point with the hose clip.

Filter in the water inlet hose blocked

Warning
Danger of death!

Do not immerse the Aqua-Stop safety device in water (it contains an electric valve).

First, reduce the water pressure in the supply hose:

1. Turn off the tap.
2. Select any programme (except **Spin** Ⓢ or **Drain** Ⓣ).
3. Select **Start/Reload** ▶|||. Allow the programme to run for approx. 40 s.
4. Turn the programme selector to ● **Off**. Pull out the mains plug.
5. Clean the filter on the tap: Disconnect the hose from the water tap. Clean the filter with a small brush.

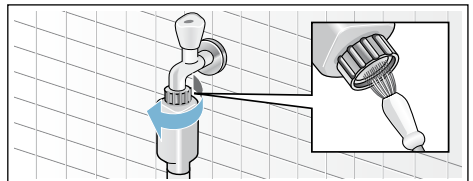

6. Clean the filter on the back of the appliance:
Remove the hose from the rear of the appliance.
Take out the filter with pliers and clean it.

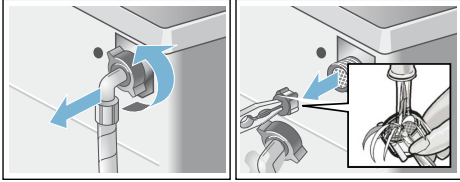

7. Connect the hose and check for leaks.

Air filter blocked

1. Turn the programme selector to ● Off. Pull out the mains plug.
2. Open and remove the service flap.
3. Take out the air filter.

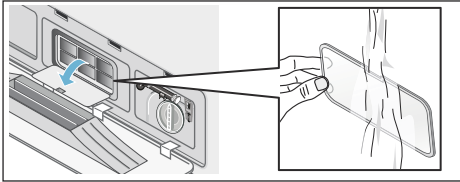

4. Rinse fluff off the air filter using a brush under running water.
5. Re-insert the air filter.
6. Re-insert and close the service flap.

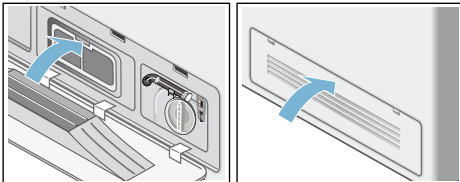

? Faults and what to do about them

Emergency release, e.g. if a power failure occurs

The programme continues running when the power supply is restored. If the washing is still to be removed, the door can be opened as described below:

Warning **Risk of scalding!**

When washing at high temperatures, you may be scalded if you touch hot washing water or the laundry. If required, leave to cool down.

Warning **Risk of injury!**

If you reach into the rotating drum, you may injure your hands. Do not reach into the rotating drum. Wait until the drum stops rotating.







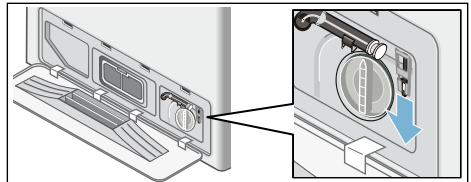

Caution! **Water damage**

Leaking water may cause damage. Do not open the door if you can still see water through the glass.









1. Turn the programme selector to ● Off. Pull out the mains plug.
2. Drain the detergent solution.
3. Pull down emergency release with a tool and release. Door can then be opened.







Information on the display panel

Display	Cause/Remedy
A:01	Close the door immediately because of the rising water level. If an interruption occurs, A:01 and OPEn are displayed alternately.
A:02	<p>The door is locked for safety reasons (water level and/or temperature too high).</p> <ul style="list-style-type: none"> ■ Washing programme: In pause mode A:02 and PAUS are displayed alternately. If you have to open the door, wait until the temperature has dropped slightly or pump out the water (select e.g. Spin  or Drain . ■ Drying programme: If you have to open the door, wait until the temperature has dropped slightly or set the drying programme to 15 min to cool down the laundry. <p>If A:02 is frequently displayed at the end of the drying programme:</p> <ul style="list-style-type: none"> ■ Clean the air filter. → <i>Page 30</i> ■ Run the Fluff Clean   (cold) programme without laundry.
A:03	Door cannot be locked/unlocked due to high temperature. Leave the washer dryer switched on for about 1 min. The washer dryer can then be locked/unlocked again.
hot	The door cannot be opened after the drying programme due to the high temperature. The cooling process continues until the display disappears, after which the door can be opened.
	<ul style="list-style-type: none"> ■ Flashes (no water supply): Tap turned on? Water inlet filter blocked? Clean the water inlet filter. → <i>Page 29</i> Water hose kinked or blocked? ■ Lights up (low water pressure): For information only. This will not affect the programme progress. The programme duration is extended.
E:18	Drain pump blocked; clean the drain pump. Clean the drainage hose on the siphon.
	<ul style="list-style-type: none"> ■ Hold down button  (Drying) for 3 seconds to delete the display. ■ Clean the air filter. → <i>Page 30</i> ■ Run the Fluff Clean   (cold) programme without laundry.
LO kg, HI kg	<p>Laundry amount information. On when drying phase finished.</p> <p>LO kg: Signals a small load for drying, HI kg: Signals a very high load for drying.</p>
Other displays	Turn the programme selector to ● Off . The appliance is switched off. Wait 5 s and switch on again. If the display is indicated again, call customer service.

Faults and what to do about them

Faults	Cause/Remedy
Water is running out.	<ul style="list-style-type: none"> ■ Correctly attach/replace drainage hose. ■ Tighten screw-fitting on the supply hose.
Water not flowing in. Detergent not dispensed.	<ul style="list-style-type: none"> ■ Start/Reload  not selected? ■ Tap not open? ■ Filter blocked? Clean the filter → <i>Page 29</i> ■ Supply hose kinked or jammed?
The washing machine door cannot be opened.	<ul style="list-style-type: none"> ■ Safety function active. Stop programme? ■  (Rinse stop = without final drain/spin) selected? ■ Can be opened with emergency lock release only? → <i>Page 30</i> ■ Childproof lock active? Deactivate.
Programme does not start.	<ul style="list-style-type: none"> ■ Start/Reload  or  (Finish in) selected? ■ Door closed?
Detergent solution is not drained.	<ul style="list-style-type: none"> ■  (Rinse stop = without final drain/spin) selected? ■ Clean the drain pump. → <i>Page 28</i> ■ Clean outlet pipe and/or drainage hose.
Water not visible in the drum.	Not a fault – water below the visible area.
Spin result not satisfactory. Laundry wet/too damp.	<ul style="list-style-type: none"> ■ Not a fault – unbalanced load detection system has stopped the spin cycle, washing unevenly distributed. Distribute small and large items of washing in the drum. ■ Too low speed selected?
Spin cycle activated several times.	Not a fault – unbalanced load detection system adjusts imbalance.
Residual water in the dispenser for care product.	<ul style="list-style-type: none"> ■ Not a fault – effect of the care product not impaired. ■ If required, remove the insert. Clean the detergent drawer and re-insert it.
Compartment  is not rinsed out completely.	Remove the insert. Clean the detergent drawer and reinsert it.
Odour formation in the washer dryer.	<ul style="list-style-type: none"> ■ Run the Fluff Clean  90°C programme without laundry. ■ Use standard detergent.
Status display  flashes. Foam may come out of the detergent drawer.	<p>Too much detergent used?</p> <ul style="list-style-type: none"> ■ Mix 1 tablespoon of fabric softener with ½ litre of water and pour into dispenser II. (Not for outdoor, sports and down-filled textiles!) ■ Reduce detergent dosage for the next wash cycle. ■ Use commercially available low foam detergent and care products which are suitable for washer dryers.
Excessive noise, vibrations and “wandering” during the spin cycle.	<ul style="list-style-type: none"> ■ Appliance aligned? Align the appliance. → <i>Page 42</i> ■ Appliance feet fixed? Secure appliance feet. → <i>Page 42</i> ■ Transportation protection devices removed? Removing the transportation protection devices → <i>Page 39</i>

Faults	Cause/Remedy
Display panel/indicator lights do not function while the appliance is running.	<ul style="list-style-type: none"> ■ Power failure? ■ Fuse tripped? Switch on/replace fuse. ■ If the fault occurs repeatedly, call customer service.
The programme duration changes during the wash cycle.	<ul style="list-style-type: none"> ■ Not a fault – unbalanced load detection system adjusts imbalance. ■ Not a fault – foam detection function active. Additional rinse cycle.
Detergent residue on the washing.	<ul style="list-style-type: none"> ■ Occasionally phosphate-free detergents contain water-insoluble residue. ■ Select Rinse  or brush items when the laundry is dry.
Spin noise during the drying phase.	This is an innovative process known as thermal spinning used to reduce energy consumption during the drying phase.
Different coloured fluff from the previous drying cycle is deposited on the laundry during the subsequent wash cycle.	Run the Fluff Clean   (cold) programme without laundry to remove fluff which has collected in the washer drum during the drying phase.
Water inlet noise during the drying phase, the tap symbol flashes during the drying phase.	The washer dryer runs a self-cleaning cycle to remove fluff which was deposited by the laundry during the drying phase. This requires a little water. Therefore, the tap must be turned on even during the drying phase.
Drying duration extended.	<ul style="list-style-type: none"> ■ According to the air cooling principle, a higher ambient temperature will result in poor drying performance, so the drying time will be extended. Ensure good ventilation to allow surplus heat to escape. ■ Air filter blocked? Clean the air filter → <i>Page 30</i> ■ Run the Fluff Clean   (cold) programme to remove fluff which has collected in the washer drum during the drying phase.
Drying programme does not start.	<ul style="list-style-type: none"> ■ Drying programme not selected? Overview of programmes ■ Door not closed properly? ■ Pump blocked? Clean the drain pump → <i>Page 28</i>

Faults	Cause/Remedy
The drying result is not satisfactory (laundry is not dry enough).	<ul style="list-style-type: none"> ■ Excessively high ambient temperature (above 30 °C) or inadequate ventilation in the room in which the washer dryer is situated. Ensure adequate ventilation to allow surplus heat to escape. ■ The laundry has not been spun well enough before drying. Always set the highest selectable spin speed for the particular washing programme. ■ Washer dryer overloaded: Observe the recommendations for the maximum load in the programme table and on the load display. Do not overload the washer dryer, as the maximum load for the drying phase is less than the maximum load for the wash cycle. Unload the washer dryer after washing with the maximum load and divide the laundry into two drying cycles. ■ The power supply voltage is too low (below 200 V) – provide a suitable power supply. ■ Air filter blocked? Clean the air filter → <i>Page 30</i> ■ Thick multilayered textiles or textiles with thick fillings dry easily on the surface, but not inside. This equalisation process may take longer. For these types of textiles, select the timed drying programmes.
When the door is opened, you will notice that a small amount of water drips onto the dried laundry.	<ul style="list-style-type: none"> ■ The drying time is reduced for a smaller load. Some residual moisture may remain in the dryer system. If the door is opened quickly, a suction effect is generated which causes the moisture to drip out of the dryer system. ■ Open the door slowly. Avoid wrenching the door open.
<p>If a fault cannot be rectified (switching the machine on and off) or a repair is required:</p> <ul style="list-style-type: none"> ■ Set the programme selector to ● Off and pull out the mains plug. ■ Turn off the tap and call customer service. 	



Customer service

If you cannot correct the fault yourself, see section, Faults and what to do about them, please contact our customer service. We will always find a suitable solution, and aim to avoid unnecessary visits by technicians.

Please give customer service the product number (E-Nr.) and the production number (FD) of the appliance.

E-Nr. _____ FD _____

Product number

Production number

You can find this information on: the inside of the door */opened service flap * and the back of the appliance.

*depending on model

Rely on the competence of the manufacturer.

















Contact us. You can therefore be sure that the repair is carried out by trained service technicians who carry original spare parts.



Technical specifications

Dimensions (width x depth x height)	60 x 59 x 84,5 cm
Weight	83 kg
Mains connection	Nominal voltage 220-240 V, 50 Hz Maximal current 10 A Maximal washing power 2400 W Maximal drying power 1900 W
Water pressure	100-1000 kPa (1-10 bar)
Drain height	60-100 cm



Consumption values

Programme	Option	Load (kg)	Energy consumption *** (kWh)	Water consumption *** (liter)	Programme duration *** (min)
Cottons  20 °C		8,0	0,25	66	128
Cottons  30 °C		8,0	0,35	61	112
Cottons  40 °C		8,0	0,55	61	112
Cottons  60 °C*	 (EcoPerfect)*	8,0	0,82	68	283
Cottons  90 °C		8,0	2,20	61	150
Easy-Care  40 °C	 (SpeedPerfect)	3,5	0,42	58	123
Mixed fabrics  40 °C	 (SpeedPerfect)	3,5	0,48	55	58
Delicates/Silk 	 (SpeedPerfect)	2,0	0,06	32	34
 Wool 		2,0	0,04	45	36
Intensive Dry 		4,0	2,47	3	156
Intensive Dry 	(Aut 2)**	4,0	2,93	3	204
Gentle Dry 		2,5	1,46	3	120

* Programme setting with maximum spin speed for testing according to or in accordance with AS/NZS 2040.2 and AS/NZS 6400.

** Programme setting for testing according to or in accordance with AS/NZS 2442.2 and AS/NZS 6400. (3L rinse water is for clean condenser)

*** The values deviate from the indicated values depending on water pressure, hardness, and inlet temperature, ambient temperature, type, amount and soiling of the laundry, detergent used, fluctuations in the power supply and selected additional functions.

Cottons  60 °C with  (EcoPerfect) is recommended for a normally soiled load.

Installation and connection

Standard accessories

Note: Check the washer dryer for damage sustained in transit. Do not switch on a damaged washer dryer. If you have any complaints, contact the dealer where you purchased the appliance or our customer service.

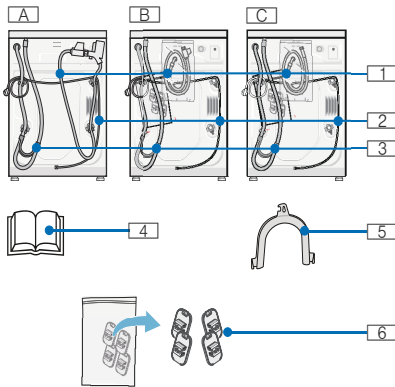

Depending on the model:

- | | |
|--|---|
| <input type="checkbox"/> A Aqua-Stop | <input type="checkbox"/> 4 Operating and installation instructions |
| <input type="checkbox"/> B Aqua-Secure | <input type="checkbox"/> 5 Elbow for fixing the water drainage hose |
| <input type="checkbox"/> C Standard | <input type="checkbox"/> 6 Covers |
| <input type="checkbox"/> 1 Water supply | |
| <input type="checkbox"/> 2 Power cord | |
| <input type="checkbox"/> 3 Water drainage hose | |

Note:

A hose clip \varnothing 24–40 mm (specialist store) is also required for connection to a siphon.

Connecting the water → Page 40

Useful tools:

- Spirit level for alignment → Page 42
- Size 13 socket wrench: for loosening the transportation protection devices → Page 39 and size 17: for aligning the appliance feet → Page 42

Installation

Note: Humidity in the drum is caused by the final inspection.

Secure installation

Warning Risk of injury!

- The washer dryer is heavy. Take care when lifting it.
- When lifting the washer dryer by its projecting parts (e.g. washer dryer door), the parts may break off and cause injuries. Do not lift the washer dryer by its projecting parts.
- If the hoses and power cables are installed incorrectly, there is a risk of stumbling and injury. Lay hoses and cables in such a way that there is no risk of stumbling.

Caution! Damage to the appliance

- Frozen hoses may tear or burst. Do not install the washer dryer outdoors and/or in an area where there is a risk of frost.
- When lifting the washer dryer by its projecting parts (e.g. washer dryer door), the parts may break off and cause injuries. Do not lift the washer dryer by its projecting parts.

Installation area

Note: Stability is important to prevent the washer dryer from wandering!

- The installation area must be firm and level.
- Soft floors and floor coverings are not suitable.
- To ensure good drying results, ensure that the room is well ventilated.

Installing the appliance on a base or on a wooden joist ceiling

Caution!

Damage to the appliance

The washer dryer may wander during the spin cycle and topple or fall off its base.

Always secure the washer dryer feet with holding brackets.

Holding brackets: order no.

WMZ 2200, WX 975600, CZ 110600, Z 7080X0.

Note: If installing on a wooden joist ceiling:

- If possible, install the washer dryer in a corner.
- Screw water-resistant wooden board (min. 30 mm thick) to the floor.

Installing the appliance under/ between kitchen units

⚠ Warning

Risk of electric shock!

Danger of death if live parts are touched.

Do not remove the appliance cover. Build under/build in before connection to the power supply.

⚠ Warning

Risk of scalding!

During the drying phase, warm air is emitted at a temperature of up to 60 °C.

Notes

- Required dimensions:
a = 650 mm
b = 620 mm
c = 850 mm

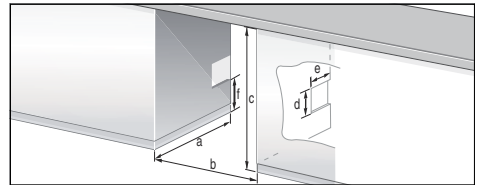

- Only install the washer dryer under a continuous worktop connected firmly to the adjacent cupboards.
- Ventilate the installation area well, otherwise the optimum drying results will not be achieved. Dimensions of the ventilation openings (to be provided on one side, depending on the circumstances). Opening cross-section: d x e = 200 mm x 100 mm. Height above floor: f = 365 mm. Distance between wall and appliance: 50 mm.

Removing the transportation protection devices

Caution! Damage to the appliance

- Before using the washer dryer for the first time, it is essential to remove all 4 transportation protection devices. Keep the transportation protection devices. The washer dryer is secured for transportation with transportation protection devices. Transportation protection devices which have not been removed may damage the drum, for example, while the washer dryer is running.
- To prevent damage in transit when transporting the appliance at a later date, always re-install the transportation protection devices prior to transportation → Page 43

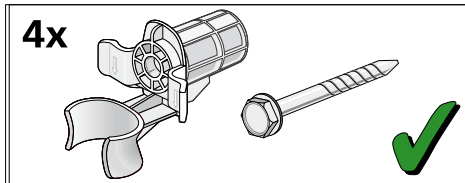

Keep the screw and sleeve screwed together.

1. Take the hoses out of the holders.
2. Take hoses out of the elbow and remove the elbow.
3. Loosen and remove all 4 transportation lock screws.

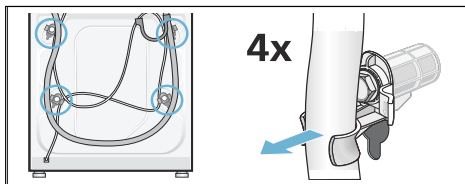

4. Take the power cord out of the holders. Remove the sleeves.

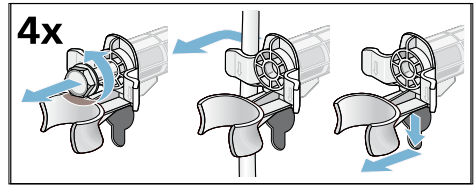

5. Insert the covers. Lock firmly by pressing on the locking hook. Insert the hose holder.

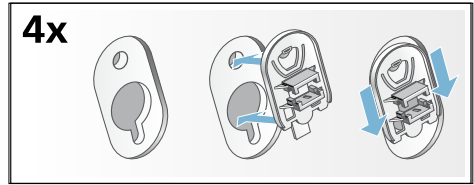

Hose and cable lengths

Connection on left side

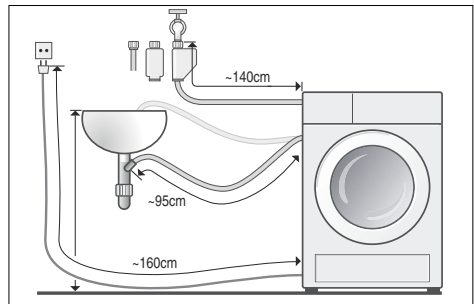

or

Connection on right side

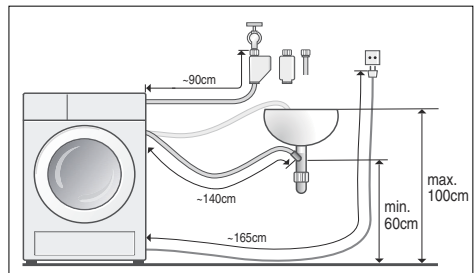

Note: If the hose holders are used, the possible hose lengths are reduced!

Available from dealer/customer service:

- Extension for Aqua-Stop or cold water inlet hose (approx. 2.50 m). Order no. WMZ 2380, WZ 10130, CZ 11350, Z 7070X0.
- Longer supply hose (approx. 2.20 m), for standard model.

Connecting the water

Warning

Risk of electric shock!

Danger of death if live parts come into contact with water.

Do not immerse the Aqua-Stop safety device in water (it contains an electric valve).

Caution!
Water damage

The connection points for the water supply and water drainage hoses are under high pressure. To prevent leakage or water damage, always follow the instructions in this chapter!

Notes

- In addition to the safety information listed here, the local water and electricity supplier may have special requirements.
- Operate the washer dryer with cold drinking water only.
- Do not connect the washer dryer to the mixer tap of an unpressurised hot water boiler.
- Use only the inlet hose supplied or one purchased from an authorised specialist outlet. Never use a used one!
- If in doubt, have the appliance connected by a technician.

Water supply

Notes

- Do not kink, crush, alter or cut through the water supply hose (otherwise, its strength can no longer be guaranteed).
- Only tighten the screw connections by hand. If the screw connections are tightened too tightly using a tool (pliers), the threads may be damaged.

Optimum water pressure in the mains: 100–1000 kPa (1–10 bar)

- When the tap is turned on, the water flow is at least 8 l/min.
- If the water pressure is higher, install a pressure reducing valve.

1. Connect the water supply hose to the tap ($\frac{3}{4}$ " = 26.4 mm) and to the appliance (except models with Aquastop):
 - Standard

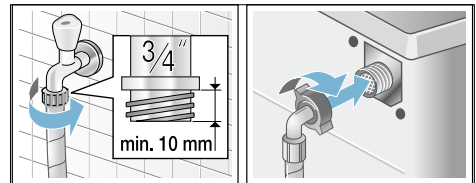

– Aqua-Secure

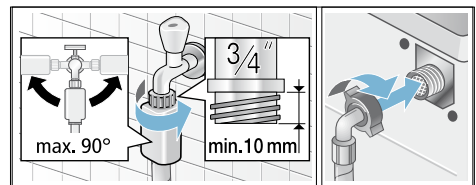

– Aqua-Stop

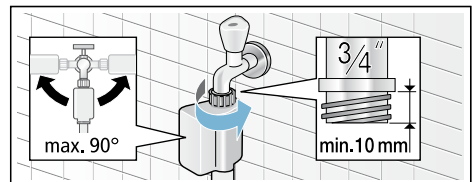

- Carefully turn on the tap and check that the connection points are not leaking.

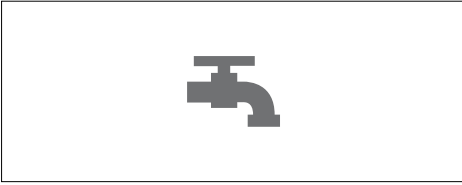

Note: The screw connection is under water pipe pressure.

Water drainage

Notes

- Do not kink or overextend the water drainage hose.
- Height difference between the placement area and drainage point: Minimum 60 cm – maximum 100 cm.

Drainage into a wash basin

Warning **Risk of scalding!**

When washing at high temperatures, you may be scalded if you touch the hot washing water (e.g. if draining hot washing water into a washbasin). Do not touch the hot washing water.

Caution! **Water damage**

If the attached drainage hose slips out of the washbasin due to high water pressure when draining the appliance, leaking water may cause damage. Secure the drainage hose to prevent it from slipping out of the washbasin.

Caution! **Damage to appliance/textiles**

If the end of the drainage hose is immersed in the drained water, water may be drawn back into the appliance

and damage the washer dryer and/or textiles.

Ensure that:

- the sealing plug does not block the outflow of the washbasin.
- the water drains quickly enough.
- the end of the drainage hose is not immersed in the drained water.

Installing the drainage hose:

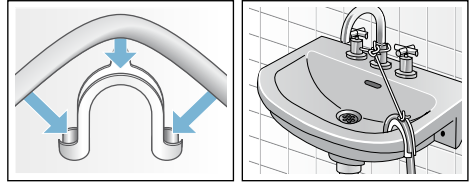

Drainage into a siphon

The connection point must be secured with a \varnothing 24–40 mm hose clip (specialist store).

Connecting

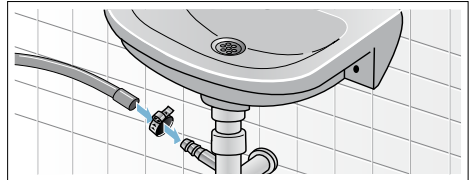

Drainage into a plastic pipe with rubber sleeve or into a gully

Connecting

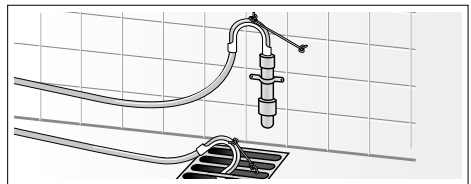

Alignment

1. Loosen the lock nut in a clockwise direction with a wrench.
2. Check the alignment of the washer dryer with a spirit level and, if required, correct. Adjust the height by rotating the appliance foot.
Note: All four appliance feet must be firmly on the floor.
The washer dryer must not wobble!
3. Tighten the lock nut against the housing.
Grip the foot and do not adjust the height.

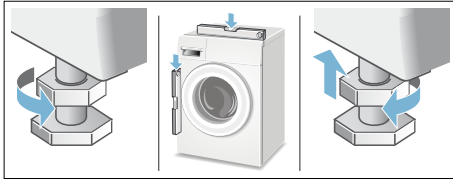

Notes

- The lock nuts on all four appliance feet must be screwed tightly against the housing!
- Any loud noises, intense vibrations or “wandering” may be due to incorrect alignment!

Electrical connection

Electrical safety

Warning **Risk of electric shock!**

Risk of death if live parts are touched.

- When disconnecting the main plug, always pull the plug itself and not the cable, otherwise the cable could be damaged.
- Never touch or hold the mains plug with wet hands.
- Never pull out the mains plug during operation.
- Only connect the washer dryer to an alternating current using a correctly installed earthed socket.
- The mains voltage must be the same as the voltage specifications on the washer dryer (appliance rating plate).
- The connected load and the required fuse are also indicated on the appliance rating plate.

Ensure that:



- The mains plug and socket match.
- The cable cross-section is adequate.
- The earthing system has been installed correctly.
- A damaged power cord is only replaced by an electrician.
A replacement mains cable can be obtained from customer service.
- You do not use multiple plugs/ couplings or extension cables.
- If a residual-current-operated circuit breaker is used, you use only a type which features this symbol: .
Only this symbol guarantees compliance with the currently valid regulations.
- The mains plug is always accessible.
- The power cord is not kinked, crushed, altered or severed and has not come into contact with any heat sources.

Before washing/drying for the first time

The washer dryer was inspected thoroughly before leaving the factory. To remove any residual test water, run the **Fluff Clean**  programme the first time **without** laundry.

Note:

- The washer dryer must have been installed and connected properly. Installation and connection → *Page 37*
- Never switch on a damaged washer dryer. Inform your customer service.

1. Insert mains plug.
2. Turn the tap on.
3. Switch on the appliance.
4. Close the door. Do not load any laundry.
5. Select the **Fluff Clean 90°C**  programme. For AU variant, two cycles of **Fluff Clean 90°C**  programme without laundry are required to be run at initial setup, and this operation only needs to be completed once.
6. Open the detergent drawer.
7. Pour approx. 1 litre of water into dispenser **II**.
8. Add standard detergent to dispenser **II** according to manufacturer's instructions for light soiling.

Note: To prevent frothing, use only half the recommended amount of detergent. Do not use any woollens or mild detergents.
9. Close the detergent drawer.
10. Select **Start/Reload** .
11. When the programme ends, switch off the appliance.

Your washer dryer is now ready for use.

Transportation

Preparatory work

1. Turn off the tap.
2. Release the water pressure in the supply hose.
Filter in the water inlet hose blocked → *Page 29*
3. Drain any residual washing water.
Drain pump blocked → *Page 28*
4. Disconnect the washer dryer from the power supply.
5. Remove the hoses.

Installing transportation protection devices:

1. Remove the covers and keep in a safe place.
If required, use a screwdriver.

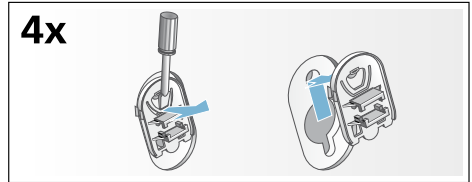

2. Insert all 4 sleeves.
Clamp the mains cable on the holders. Insert and tighten the bolts.

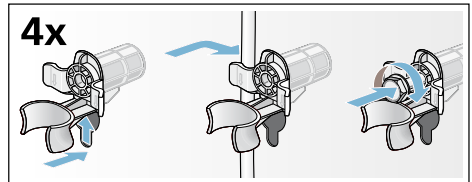

Before switching on the appliance:

Notes

- **Always** remove the transportation protection devices!
- To prevent unused detergent from flowing into the outlet during the next wash: Pour 1 litre of water into dispenser **II** and start the **Spin** or **Drain** programme.

Aqua-Stop warranty

Only for appliances with Aqua-Stop

In addition to warranty claims against the vendor based on the purchase agreement and to our appliance warranty, we will provide compensation under the following conditions:

1. If water damage is caused due to a fault in our Aqua-Stop system, we will compensate domestic customers for the damage caused.
2. The liability guarantee is valid for the service life of the appliance.
3. It is a prerequisite of all warranty claims that the appliance with Aqua-Stop must have been installed and connected correctly in accordance with our instructions; this also includes a correctly fitted Aqua-Stop extension (genuine accessories).

Our warranty does not cover defective feed lines or fittings leading to the Aqua-Stop connection at the tap.

4. Appliances with Aqua-Stop do not need to be supervised during operation, nor secured afterwards by turning off the tap.
The tap only needs to be turned off if you are away from home for a long period, e.g. for several weeks' holiday.

Robert Bosch Hausgeräte GmbH
Carl-Wery-Straße 34
81739 München, GERMANY



9001168796 (9602)