

**BO 470/471**

**BO 480/481**

Oven

---

## Table of contents

---

<b>Important safety information</b>	<b>4</b>
Causes of damage	6
<b>Environmental protection</b>	<b>6</b>
Environmentally-friendly disposal	6
Tips for saving energy	6
<b>Getting to know the appliance</b>	<b>7</b>
Oven	7
Display and operating controls	8
Symbols	8
Colours and display	9
Automatic door opening	9
Additional information <b>i</b> and <b>i</b> <sup>®</sup>	9
Cooling fan	9
Function selector positions	10
Accessories	12
Special accessories	12
<b>Before using for the first time</b>	<b>13</b>
Setting the language	13
Setting the time format	13
Setting the clock	13
Setting the date format	13
Setting the date	14
Setting the temperature format	14
Ending initial set-up	14
Heating up the oven	14
Cleaning accessories	14
<b>Activating the appliance</b>	<b>15</b>
Standby	15
Activating the appliance	15
<b>Operating the appliance</b>	<b>15</b>
Cooking compartment	15
Inserting accessories	16
Switching on	16
Rapid heating	16
Safety shut-off	16
<b>Timer functions</b>	<b>17</b>
Calling up the timer menu	17
Timer	17
Stopwatch	17
Cooking time	18
End of cooking time	19
<b>Long-term timer</b>	<b>20</b>
Setting the long-term timer	20
<b>Individual recipes</b>	<b>21</b>
Recording a recipe	21
Programming a recipe	21
Entering names	22

Starting recipes	22
Change recipe	22
Deleting recipes	22

---

<b>Core temperature probe</b>	<b>23</b>
Inserting the core temperature probe in the food to be cooked	23
Setting the core temperature	24
Core temperature guidelines	25

---

<b>Rotisserie spit</b>	<b>26</b>
Preparation	26
Switching on the rotisserie spit	26
Switching off the rotisserie spit	26

---

<b>Roasting function</b>	<b>27</b>
--------------------------	-----------

---

<b>Child lock</b>	<b>27</b>
Activate the child lock	27
Deactivating the child lock	27

---

<b>Basic settings</b>	<b>28</b>
-----------------------	-----------

---

<b>Cleaning and maintenance</b>	<b>30</b>
Cleaning agents	30
Removing slide-in racks	31

---

<b>Pyrolytic cleaning (self-cleaning)</b>	<b>31</b>
Preparing pyrolytic self-cleaning	31
Starting pyrolytic self-cleaning	32
Cleaning accessories with pyrolytic self-cleaning	32

---

<b>Trouble shooting</b>	<b>33</b>
Power cut	33
Demo mode	33
Replacing the oven light bulb	34

---

<b>After-sales service</b>	<b>34</b>
E number and FD number	34

---

<b>Settings table and tips</b>	<b>35</b>
Vegetables	35
Side dishes and meals	37
Fish	39
Meat	40
Poultry	42
Grilling and roasting/baking	43
Baking	45
Raising dough	49
Desserts	49
Defrosting	50
Preserving	51
Disinfecting	51
Drying	52
Baking stone	52
Roasting dish	53
Acrylamide in foodstuffs	55

Additional information on products, accessories, replacement parts and services can be found at [www.gaggenau.com](http://www.gaggenau.com) and in the online shop [www.gaggenau.com/zz/store](http://www.gaggenau.com/zz/store)

## **⚠ Important safety information**

Read these instructions carefully. Only then will you be able to operate your appliance safely and correctly. Retain the instruction manual and installation instructions for future use or for subsequent owners.

This appliance is only intended to be fully fitted in a kitchen. Observe the special installation instructions.

Check the appliance for damage after unpacking it. Do not connect the appliance if it has been damaged in transport.

Only a licensed professional may connect appliances without plugs. Damage caused by incorrect connection is not covered under warranty.

This appliance is intended for domestic use only. The appliance must only be used for the preparation of food and drink. The appliance must be supervised during operation. Only use this appliance indoors.

This appliance is intended for use up to a maximum height of 2000 metres above sea level.

This appliance may be used by children over the age of 8 years old and by persons with reduced physical, sensory or mental capabilities or by persons with a lack of experience or knowledge if they are supervised or are instructed by a person responsible for their safety how to use the appliance safely and have understood the associated hazards.

Children must not play with, on, or around the appliance. Children must not clean the appliance or carry out general maintenance unless they are at least 8 years old and are being supervised.

Keep children below the age of 8 years old at a safe distance from the appliance and power cable.

Always slide accessories into the cooking compartment correctly. See description of accessories in the instruction manual.

### **Risk of fire!**

- Combustible items stored in the cooking compartment may catch fire. Never store combustible items in the cooking compartment. Never open the appliance door if there is smoke inside. Switch off the appliance and unplug it from the mains or switch off the circuit breaker in the fuse box.
- A draught is created when the appliance door is opened. Greaseproof paper may come into contact with the heating element and catch fire. Do not place greaseproof paper loosely over accessories during preheating. Always weight down the greaseproof paper with a dish or a baking tin. Only cover the surface required with greaseproof paper. Greaseproof paper must not protrude over the accessories.

### **Risk of burns!**

- The appliance becomes very hot. Never touch the interior surfaces of the cooking compartment or the heating elements. Always allow the appliance to cool down. Keep children at a safe distance.
- Accessories and ovenware become very hot. Always use oven gloves to remove accessories or ovenware from the cooking compartment.
- Alcoholic vapours may catch fire in the hot cooking compartment. Never prepare food containing large quantities of drinks with a high alcohol content. Only use small quantities of drinks with a high alcohol content. Open the appliance door with care.

### **Risk of scalding!**

- The accessible parts become hot during operation. Never touch the hot parts. Keep children at a safe distance.
- When you open the appliance door, hot steam may escape. Open the appliance door with care. Keep children at a safe distance.
- Water in a hot cooking compartment may create hot steam. Never pour water into the hot cooking compartment.

### **Risk of injury!**

Scratched glass in the appliance door may develop into a crack. Do not use a glass scraper, sharp or abrasive cleaning aids or detergents.

### **Risk of electric shock!**

- Incorrect repairs are dangerous. Repairs may only be carried out and damaged power cables replaced by one of our trained after-sales technicians. If the appliance is defective, unplug the appliance from the mains or switch off the circuit breaker in the fuse box. Contact the after-sales service.
- The cable insulation on electrical appliances may melt when touching hot parts of the appliance. Never bring electrical appliance cables into contact with hot parts of the appliance.
- Do not use any high-pressure cleaners or steam cleaners, which can result in an electric shock.
- When replacing the cooking compartment bulb, the bulb socket contacts are live. Before replacing the bulb, unplug the appliance from the mains or switch off the circuit breaker in the fuse box.
- A defective appliance may cause electric shock. Never switch on a defective appliance. Unplug the appliance from the mains or switch off the circuit breaker in the fuse box. Contact the after-sales service.
- The insulation of an incompatible meat probe may be damaged. Only use the meat probe which is recommended for this appliance.

### **Risk of fire!**

- Loose food residues, grease and meat juices may catch fire during pyrolytic cleaning. Remove coarse dirt from the cooking compartment and from the accessories before every pyrolytic cleaning cycle.
- The appliance will become very hot on the outside during the pyrolytic cleaning cycle. Never hang combustible objects, e.g. tea towels, on the door handle. Do not place anything against the front of the oven. Keep children at a safe distance.

### **Risk of burns!**

- The cooking compartment will become very hot during the pyrolytic cleaning cycle. Never open the appliance door or move the locking latch by hand. Allow the appliance to cool down. Keep children at a safe distance.
-  The appliance will become very hot on the outside during the Self-cleaning cycle. Never touch the appliance door. Allow the appliance to cool down. Keep children at a safe distance.

### **Risk of serious damage to health!**

The appliance will become very hot during the pyrolytic cleaning cycle. The non-stick coating on baking trays and tins is destroyed and noxious gases are released. Never let non-stick baking trays and tins go through the pyrolytic cleaning cycle. Only enamelled accessories may be cleaned at the same time.

## Causes of damage

### Caution!

- Accessories, foil, greaseproof paper or ovenware on the cooking compartment floor: do not place accessories on the cooking compartment floor. Do not cover the cooking compartment floor with any sort of foil or greaseproof paper. Do not place ovenware on the cooking compartment floor if a temperature of over 50 °C has been set. This will cause heat to accumulate. The baking and roasting times will no longer be correct and the enamel will be damaged.
- Water in a hot cooking compartment: do not pour water into the cooking compartment when it is hot. This will cause steam. The temperature change can cause damage to the enamel.
- Moist food: do not store moist food in the cooking compartment when it is closed for prolonged periods. This will damage the enamel.
- Fruit juice: when baking particularly juicy fruit pies, do not pack the baking tray too generously. Fruit juice dripping from the baking tray leaves stains that cannot be removed. If possible, use the deeper universal pan.
- Cooling with the appliance door open: only allow the cooking compartment to cool when it is closed. Even if the appliance door is only open a little, front panels of adjacent units could be damaged over time.
- Very dirty door seal: If the door seal is very dirty, the appliance door will no longer close properly when the appliance is in use. The fronts of adjacent units could be damaged. Always keep the door seal clean.
- Appliance door as a seat, shelf or worktop: Do not sit on the appliance door, or place or hang anything on it. Do not place any cookware or accessories on the appliance door.
- Inserting accessories: depending on the appliance model, accessories can scratch the door panel when closing the appliance door. Always insert the accessories into the cooking compartment as far as they will go.
- Carrying the appliance: do not carry or hold the appliance by the door handle. The door handle cannot support the weight of the appliance and could break.

---

## Environmental protection

---

### Environmentally-friendly disposal

Dispose of packaging in an environmentally-friendly manner.



This appliance is labelled in accordance with European Directive 2012/19/EU concerning used electrical and electronic appliances (waste electrical and electronic equipment - WEEE). The guideline determines the framework for the return and recycling of used appliances as applicable throughout the EU.

### Tips for saving energy

- Open the appliance door as little as possible while cooking, baking or roasting.
- Use dark, black lacquered or enamelled baking tins for baking. They absorb the heat particularly well.
- It is best to bake several cakes one after the other. The oven will still be hot. This reduces the baking time for the second cake. You can also place two loaf tins next to each other.
- In the hot air mode, you can bake on several levels at the same time.
- If the cooking time is relatively long, you can switch off the oven 10 minutes before the end of the cooking time and use the oven's residual heat to complete the cooking process.

---

## Getting to know the appliance

---

Use this section to familiarise yourself with your new appliance. The control panel and the individual operating controls are explained. You will find information on the cooking compartment and the accessories.

### Oven

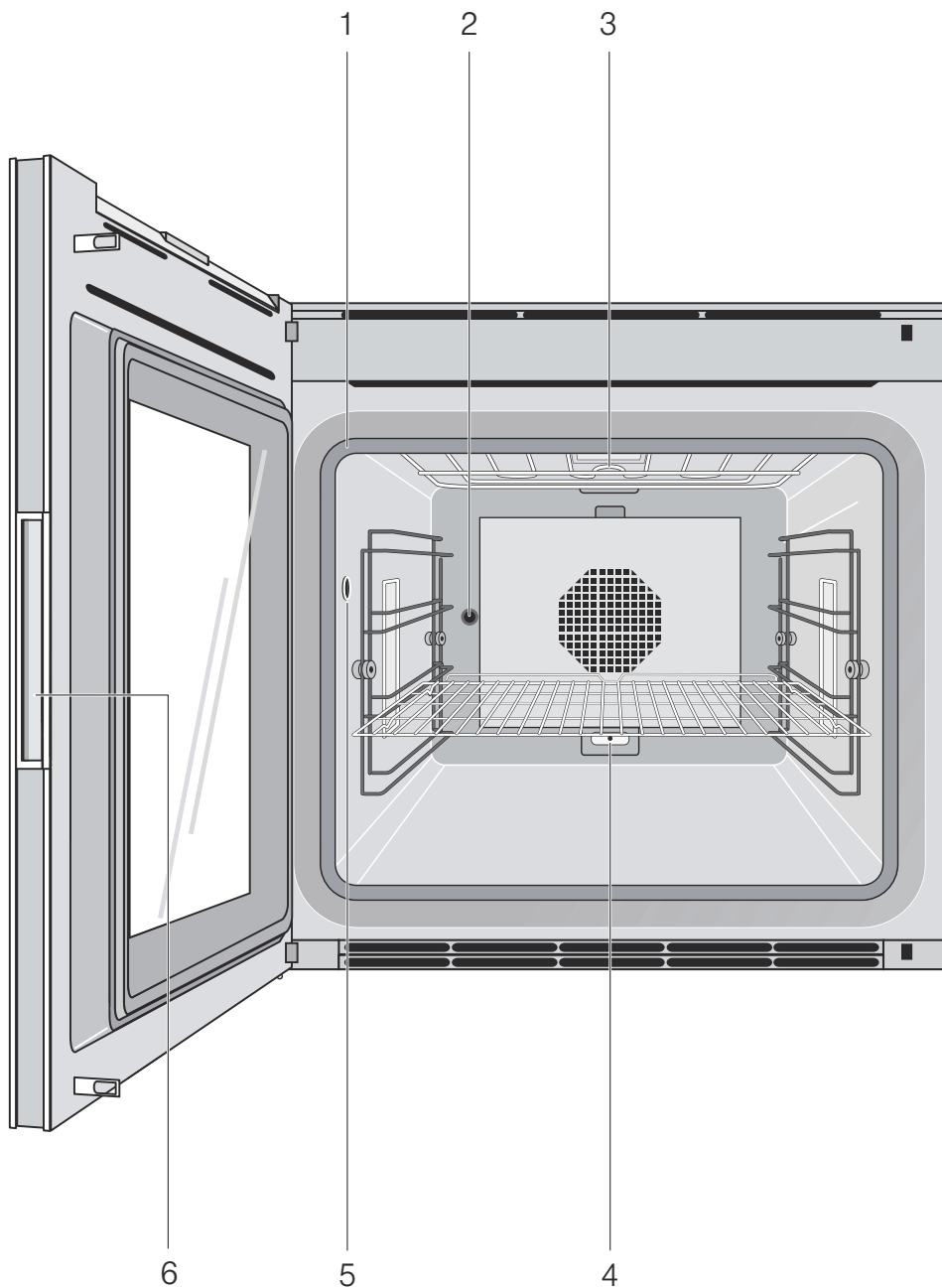

---

1	Door seal
2	Rotisserie spit drive
3	Grill heating element
4	Socket for additional heating element (special accessory for baking stone and roaster)
5	Socket for core temperature probe
6	Recessed handle

---

## Display and operating controls

These instructions are valid for different versions of the appliance. There may be minor differences depending on the appliance model.

All versions of the appliance are operated in an identical manner.

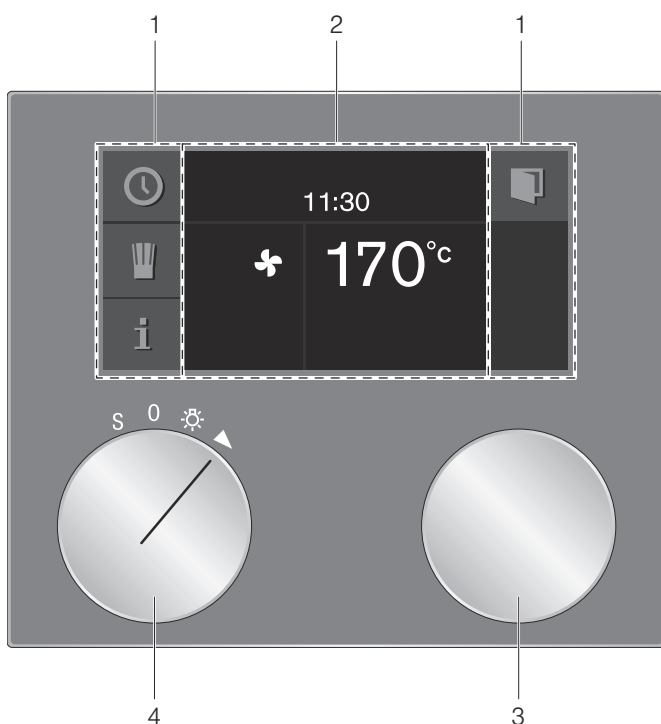

1	Control panel	These areas are touch sensitive. Touch a symbol to select the corresponding function.
2	Display	The display shows, for example, current settings and options.
3	Rotary selector	You can use the rotary selector to set the temperature and to make further settings.
4	Function selector	The function selector is used to select the type of heating, the cleaning function or the basic settings.

## Symbols

Symbol	Function
▶	Start
■	Stop
	Pause/End
X	Cancel
C	Delete
✓	Confirm/save settings
>	Selection arrow
🔒	Open appliance door
i	Call up additional information
»»	Rapid heating with status indicator
🍷	Call up individual recipes
rec ●	Record menu
✎	Edit settings
>A <sup>A</sup>	Enter name
✂	Delete letters
🔒	Child lock
🕒	Call up timer menu
🕒	Call up long-term timer
🔧	Demo mode
🍖	Call up core temperature probe
🍖	Start rotisserie spit
🍖	Stop rotisserie spit
»»	Start roasting function
»»	End roasting function



## Colours and display

### Colours

The different colours are used to guide the user in the relevant setting situations.

Orange	Initial settings Main functions
Blue	Basic settings Cleaning
White	Values which can be set

### Display

The appearance of the symbols, values or the entire display changes depending on the situation.

Zoom	The setting which is currently being changed is displayed in an enlarged format.  A cooking time that is coming to an end is shown in an enlarged format shortly before running out (e.g. the last 60 seconds of the timer).
Reduced display	After a short time, the display is reduced and only the most important information is displayed. This function is preset and can be changed in the basic settings.

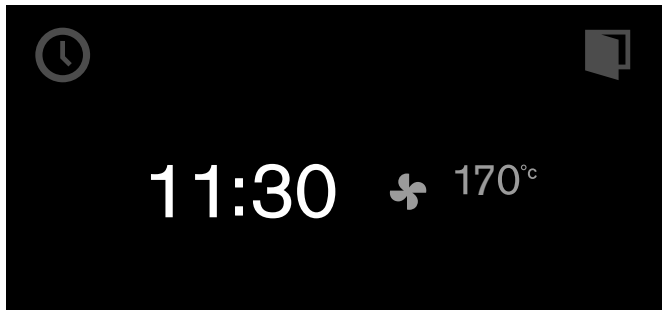

## Automatic door opening

The appliance door springs open when you touch the  symbol and you can open it fully by using the recessed handle on the side.

Automatic door opening does not work if the child lock is activated or there is a power cut. You can open the recessed handle on the side by hand.

## Additional information **i** and **i**<sup>Ⓞ</sup>

By touching the **i** symbol, you can call up additional information. For example, information on the heating function set or on the current temperature of the cooking compartment.

**Note:** During continuous operation, small fluctuations in temperature are normal after the oven has heated up.

The **i**<sup>Ⓞ</sup> symbol is displayed for important information and action prompts. Important information on safety and operation mode are occasionally shown automatically. These messages either disappear automatically after a few seconds or must be confirmed with .

## Cooling fan

Your appliance has a cooling fan. The cooling fan switches on during operation. Depending on the appliance version, the hot air escapes above or under the door.

After removing cooked food, keep the door closed until the appliance cools down. The appliance door must not be left ajar, as adjoining kitchen furniture may be damaged. The cooling fan continues to run for a certain time after operation and then switches off automatically.

### Caution!





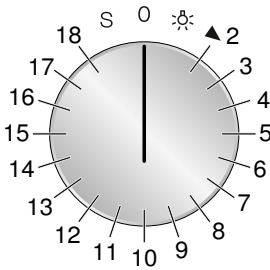

Do not cover the ventilation slots. Otherwise, the appliance will overheat.

## Function selector positions



Position	Function/heating function	Temperature	Use
0	Off position		
☀	Light		
2	Hot air	50 - 300 °C Default temperature 170 °C	Hot air (fan oven): For cakes, biscuits and bakes on more than one level. The fan in the back panel of the oven distributes the heat evenly throughout the cooking compartment.
3	Eco hot air*	50 - 300 °C Default temperature 170 °C	Energy-saving hot air mode for cakes, small baked items, bakes and gratins. The oven lighting remains off.
4	Top + bottom heat	50 - 300 °C Default temperature 170 °C	For cakes in tins or on a baking tray, bakes, roasts.
5	Top + 1/3 bottom heat	50 - 300 °C Default temperature 170 °C	For tray bakes, biscuits, cakes with meringue, grilling and browning bakes. Very well suited for heating the food once again specifically from above towards the end of preparation.
6	Top heat	50 - 300 °C Default temperature 170 °C	Targeted heat from above, for example grilling fruit flan with meringue.
7	1/3 Top + bottom heat	50 - 300 °C Default temperature 170 °C	For cheesecake, bread in loaf tins, dishes in a bain marie (e.g. egg custard and crème brûlée). For roasting without a lid and warming up food (food dries out less). Very well suited for heating the food once again specifically from below towards the end of preparation.
8	Bottom heat	50 - 300 °C Default temperature 170 °C	For the final baking stage (such as for moist fruit flans), for boiling down, for dishes in a bain marie.
9	Hot air + bottom heat	50 - 300 °C Default temperature 170 °C	Additional heat from below for moist cakes and flans, such as fruit flans.
10	Hot air + 1/3 bottom heat	50 - 300 °C Default temperature 170 °C	For high bakes, lasagne, onion tart, egg dishes (e.g. tortilla and farmers' omelettes).
11	Full surface grill + circulated air	50 - 300 °C Default temperature 220 °C	Even, all-round heating for meat, poultry and whole fish.
12	Full surface grill	50 - 300 °C Default temperature 220 °C	For grilling flat pieces of meat, sausages or fillets of fish. Grilling and browning.
13	Compact grill	50 - 300 °C Default temperature 220 °C	Only the centre part of the grill heating element is heated. Energy-saving grilling for small amounts of food.

\* Heating function used to determine the energy efficiency class in accordance with EN60350-1.

Position	Function/heating function	Temperature	Use
14	 Baking stone function	50 - 300 °C Default temperature 250 °C	Baking stone only available as an optional accessory Baking stone heated from below for crisp stone-baked pizza, bread or bread rolls.
15	 Roaster function	50 - 220 °C Default temperature 180 °C	Roasting dish only available as an optional accessory Heatable cast iron roasting pan for large joints of meat, bakes or festive roasts.
16	 Dough proving	30 - 50 °C Default temperature 38 °C	Proving: For yeast dough and sour dough. Dough will rise considerably more quickly than at room temperature. The optimal temperature setting for yeast dough is 38 °C.
17	 Defrosting	40 - 60 °C Default temperature 45 °C	Even, gentle defrosting. For vegetables, meat, fish and fruit.
18	 Keeping warm	30 - 120 °C Default temperature 70 °C	Keeping food warm, pre-heating porcelain cookware.
S	 Basic settings		Your appliance can be individually adjusted in the basic settings.
	 Pyrolytic self-cleaning	485 °C	Self-cleaning
* Heating function used to determine the energy efficiency class in accordance with EN60350-1.			

## Accessories

Use only the accessories supplied with the product or available from the after-sales service. They are specially designed for your appliance. Ensure that you always insert the accessories into the cooking compartment the right way round.

Your appliance is equipped with the following accessories:

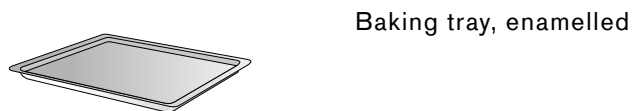

Baking tray, enameled



Wire rack



Grill tray with wire rack

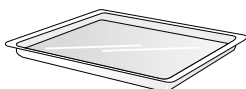

Glass tray (only with ovens 60 cm wide)

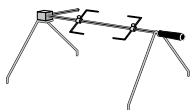

Rotisserie spit

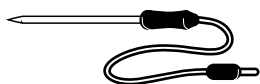

Plug-in core temperature probe

## Special accessories

You can order the following special accessories from your specialist dealer:

### BO 470/471

BA 476 110 Handle, stainless steel

BA 016 105 Pull-out system  
Fully extendable telescopic pull-out rack and cast-iron frame which can withstand pyrolytic cleaning

BA 026 105 Grill tray, enameled, 30 mm deep

BA 026 115 Baking tray, enameled 15 mm deep

BA 036 105 Wire rack, chrome-plated, without opening, with feet

BA 046 115 Glass dish, 24 mm deep

BA 056 115 Heating element for baking stone and roaster (230 V)

BA 056 125 Heating element for baking stone and roaster (400 V)

BA 056 133 Baking stone  
Including baking stone support and pizza paddle (order heating element separately)

BS 020 002 Pizza paddle, set of 2

GN 340 230 Cast aluminium roaster GN 2/3, 165 mm high, non-stick coated

### BO 480/481

BA 478 110 Handle, stainless steel

BA 018 105 Pull-out system  
Fully extendable telescopic pull-out rack and pyrolysis-proof cast frame

BA 028 115 Baking tray, enameled, 30 mm deep

BA 038 105 Wire rack, chromium-plated, without opening, with feet

BA 058 115 Heating element for baking stone and roaster

BA 058 133 Baking stone  
Including baking stone support and pizza paddle (order heating element separately)

BS 020 002 Pizza paddle, set of 2

GN 340 230 Cast aluminium roaster GN 2/3, 165 mm high, non-stick coated

Only use the accessories as specified. The manufacturer accepts no liability if these accessories are used incorrectly.

## Before using for the first time

In this section, you can find out what you must do before using your appliance to prepare food for the first time. Read the section entitled 'Important safety information' beforehand.

The appliance must be fully installed and connected to the mains.

After connection to the mains, the "Initial settings" menu appears in the display. You can now make settings for your new appliance.

- Language
- Time format
- Time
- Date format
- Date
- Temperature format

### Notes

- The "Initial settings" menu will appear only after the appliance has been connected to a power supply and switched on for the first time, or if the appliance has not been connected to a power supply for a number of days. Once the appliance has been connected to a power supply, the GAGGENAU logo will appear first for approximately 30 seconds. The "Initial settings" menu will then appear automatically.
- You can change the settings at any time (see section entitled 'Basic settings').

## Setting the language

The preset language appears in the display.

- 1 Turn the rotary selector to select the required display language.
- 2 Confirm with ✓.

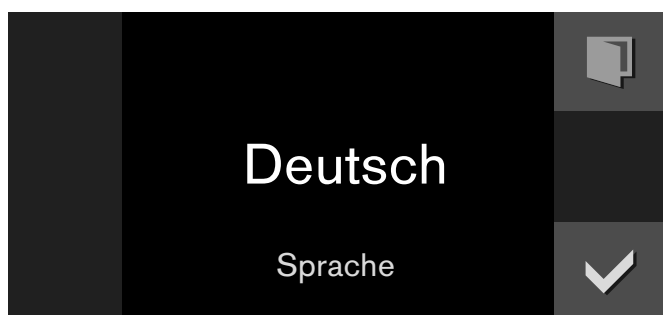

**Note:** If the language is changed, the system restarts. This takes a few seconds.

## Setting the time format

The two possible formats 24h and AM/PM appear in the display. The default is the 24h format.

- 1 Use the rotary selector to select the desired format.
- 2 Confirm with ✓.

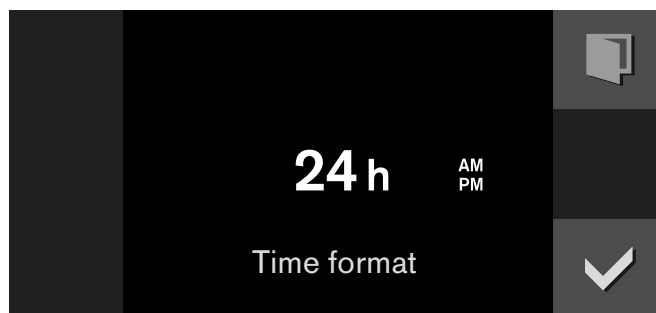

## Setting the clock

The time is shown in the display.

- 1 Set the desired time using the rotary selector.
- 2 Confirm with ✓.

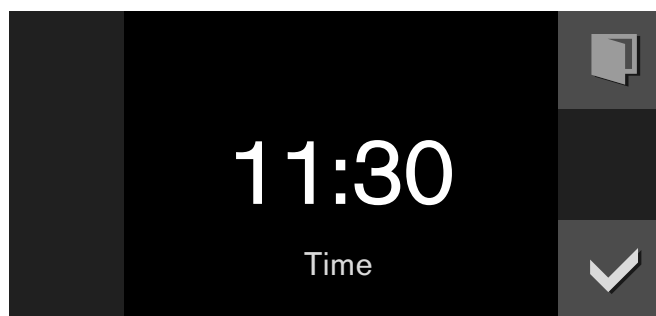

## Setting the date format

The three possible formats D.M.Y, D/M/Y and M/D/Y appear in the display. The default is the D.M.Y format.

- 1 Use the rotary selector to select the desired format.
- 2 Confirm with ✓.

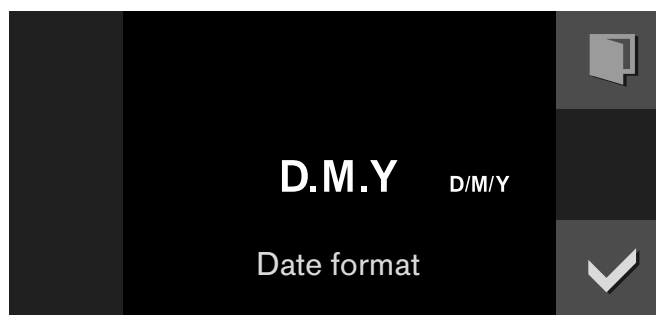

## Setting the date

The preset date appears in the display. The day setting is already active.

- 1 Set the day using the rotary selector.
- 2 Touch the > symbol to switch to the month setting.
- 3 Set the month using the rotary selector.
- 4 Touch the > symbol to switch to the year setting.
- 5 Set the year using the rotary selector.
- 6 Confirm with ✓.

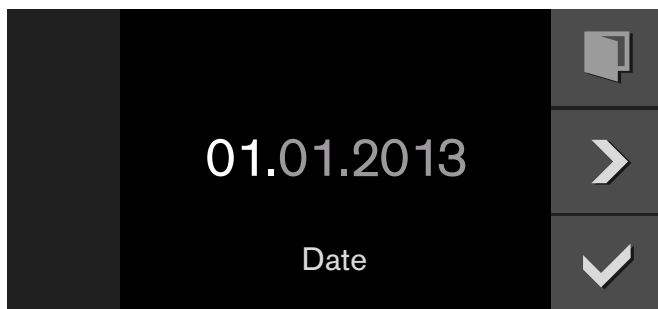

## Setting the temperature format

The two possible formats °C and °F appear in the display. The default setting is °C.

- 1 Use the rotary selector to select the desired format.
- 2 Confirm with ✓.

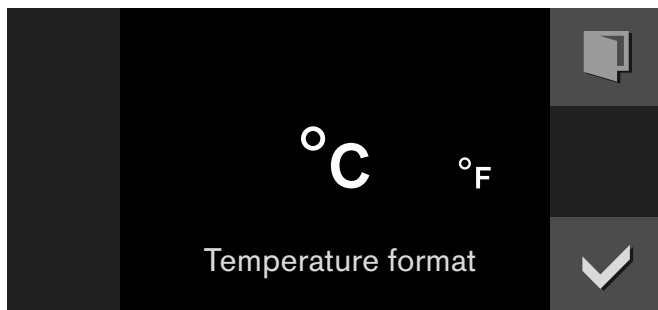

## Ending initial set-up

"Initial set-up complete" appears in the display.

Confirm with ✓.

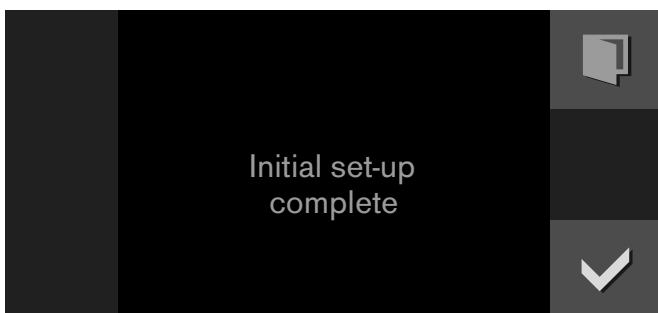

The appliance enters standby mode and the standby screen appears. The appliance is now ready for operation.

## Heating up the oven

Ensure that no packaging remnants have been left in the cooking compartment.

To remove the new cooker smell, heat up the oven when it is empty and closed. One hour with  Hot air at 200°C is ideal. For instructions on how to set this type of heating, refer to the Operating the appliance section.

## Cleaning accessories

Before using the accessories for the first time, clean them thoroughly using hot detergent solution and a soft cloth.

---

## Activating the appliance

---

### Standby

The appliance goes into standby mode if no function has been set or the child lock is activated.

The brightness of the control panel is dimmed in standby mode.



#### Notes

- Different displays are available for standby mode. The default setting is the GAGGENAU logo and the clock. To change the display, refer to the Basic settings section.
- The brightness of the display depends on the vertical viewing angle. You can adjust the display using the "Brightness" setting in the basic settings.

## Activating the appliance

To exit standby mode, you can either

- Turn the function selector,
- Touch a control panel,
- Open or close the door.

You can now set the desired function. You can read about how to set functions in the respective chapters.

#### Notes

- When "Standby screen = off" is selected in the basic settings, you must turn the function selector to exit standby mode.
- The appliance returns to the standby screen if you have not made any settings for a long time after activation.
- When the door is open, the interior lighting switches off after a short time.

---

## Operating the appliance

---

### Cooking compartment

Depending on the oven version, the cooking compartment has four or five shelf levels. The shelf levels are counted from the bottom up.

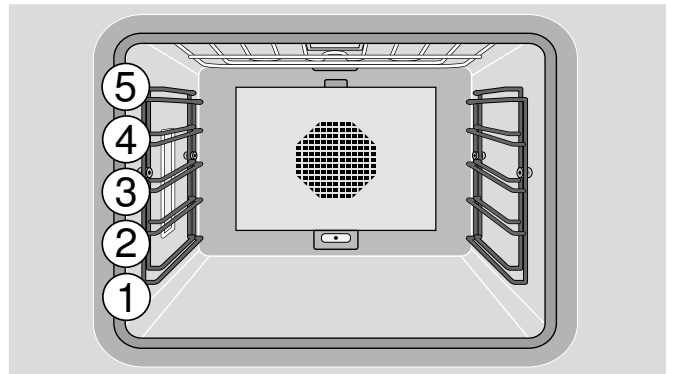
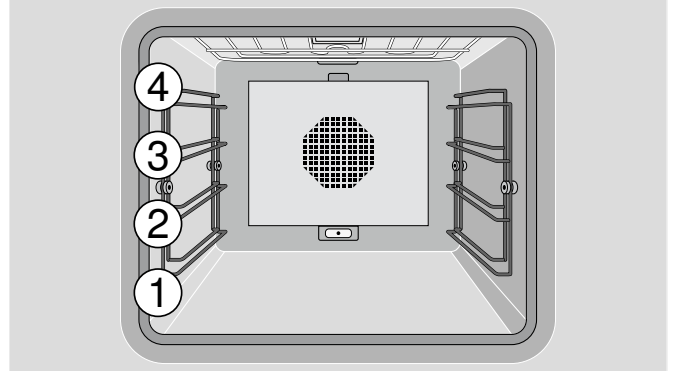

#### Caution!

- Do not place anything on the cooking compartment floor. Do not cover it with aluminium foil. A build-up of heat could damage the appliance.
- Do not slide any accessories between the shelf positions, or they may tip.

## Inserting accessories

The accessories are equipped with a locking function. The locking function prevents the accessories from tilting when they are pulled out. The accessories must be inserted into the cooking compartment correctly for the tilt protection to work properly.

When inserting the wire rack, check

- that the lug (a) is pointing downwards
- that the safety bar on the wire rack is at the back and facing upwards.

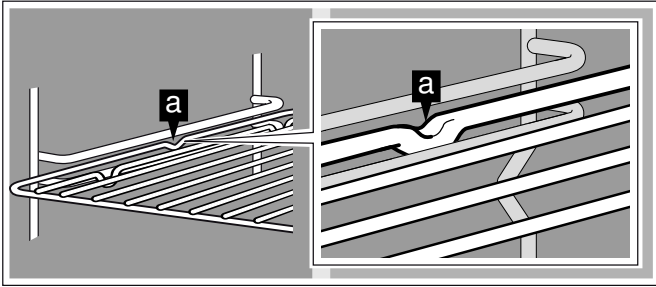

## Switching on

- 1 Set the required heating mode using the function selector. The chosen heating mode and the default temperature are displayed.
- 2 If you want to change the default temperature: set the required temperature with the rotary selector.

The preheating symbol  $\gg$  appears on the display. The bar continuously shows the preheating status. When the set temperature is reached, a signal sounds and the preheating symbol  $\gg$  goes off.

**Note:** The oven interior lighting stays switched off at a temperature setting below 70°C

### Switching off:

Turn the function selector to 0.

## Rapid heating

With the "Rapid heat-up" function, your appliance reaches the desired temperature particularly quickly in the top heating, bottom heating and top/bottom heating types of heating.

To ensure an even cooking result, do not place your food in the cooking compartment until "Rapid heat-up" is complete and the  $\gg$  heat-up symbol goes out.

**Note:** The "Rapid heat-up" function is preset in the factory settings. In the basic settings, you can select  $\gg$  Rapid heat-up or  $\wedge$  Heat-up.

## Safety shut-off

For your protection, the appliance is equipped with an automatic safety shut-off. Any heating process is switched off after 12 hours if the oven is not operated in this time. A message appears in the display.

Exception:

The long-term timer has been programmed.

Set the function selector to 0, then the appliance can be operated again as usual.



## Timer functions

You use the timer menu to make the following settings:

- ⌚ Short-term timer
- ⌚ Stopwatch
- 🕒 Cooking time (not in standby mode)
- 🕒 Cooking time end (not in standby mode)

### Calling up the timer menu

You can call up the timer menu from any mode. Only from the basic settings, function selector is set to **S**, the timer menu is not available.

Touch the 🕒 symbol.

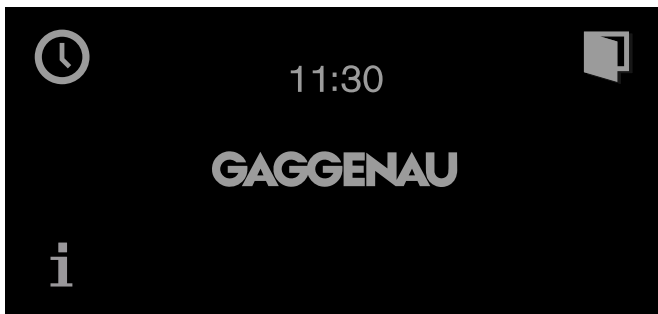

The timer menu is displayed.

### Timer

The timer runs independently of the other appliance functions. You can enter a maximum of 90 minutes.

#### Setting the timer

- 1 Call up timer menu.  
The "Timer" ⌚ function is displayed.
- 2 Turn the rotary selector to set the required cooking time.

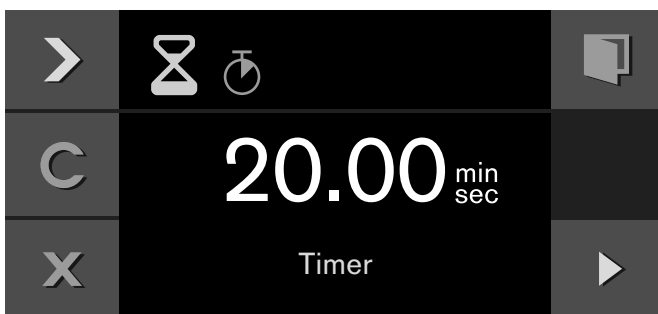

- 3 Start with ▶.

The timer menu closes and the time begins to count down. The ⌚ symbol and the countdown appear in the display.

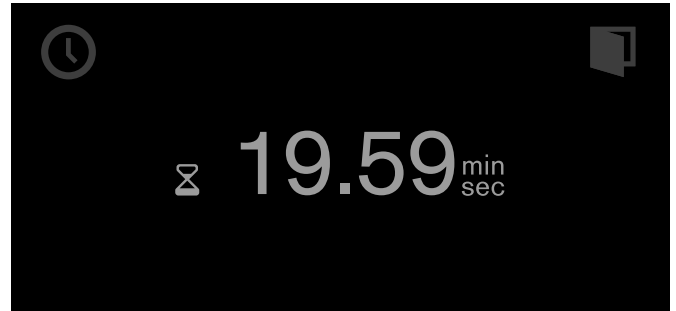

A signal sounds once the time has elapsed. Touch the ✓ symbol to silence.

You can exit the timer menu at any time by touching the ✕ symbol. This erases the settings.

#### To stop the timer:

Call up timer menu. Touch ▶ to select the "Timer" ⌚ function and touch the || symbol. To allow the timer to continue counting down, touch the ▶ symbol.

#### Switching off the timer early:

Call up timer menu. Touch ▶ to select the "Timer" ⌚ function and touch the C symbol.

### Stopwatch

The stopwatch runs independently of the other appliance functions.

The stopwatch counts from 0 seconds up to 90 minutes.

It also has a pause function, which enables you to temporarily stop the clock.

#### Starting the stopwatch

- 1 Call up the "Timer" menu.
- 2 Touch ▶ to select the ⌚ "Stopwatch" function.

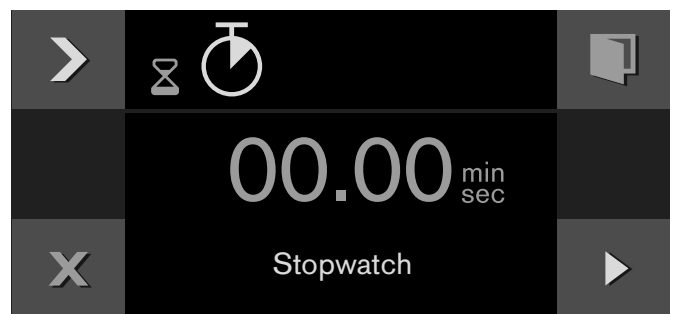

- 3 Press ▶ to start.

The "Timer" menu is closed and the time starts counting down. The ⌚ symbol and the elapsed time are shown in the display.

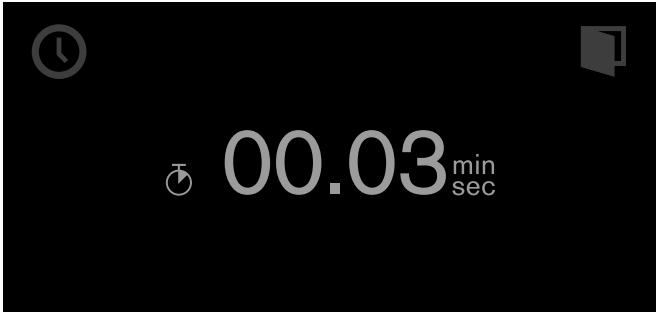

### Pausing and restarting the stopwatch

- 1 Call up the "Timer" menu.
- 2 Touch ▶ to select the ⌚ "Stopwatch" function.
- 3 Touch the || symbol.

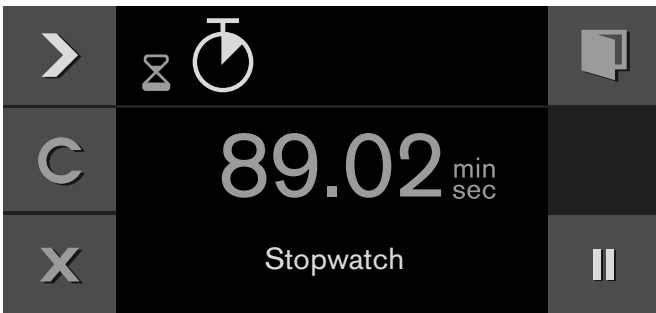

The time stops. The symbol changes to ▶ "Start".

- 4 Press ▶ to start.

The time continues to run. When 90 minutes is reached, the display pulsates and a signal sounds. The signal stops when you touch the ✓ symbol. The ⌚ symbol in the display goes out. The process has finished.

### To switch off the stopwatch:

Call up the "Timer" menu. Touch ▶ to select the ⌚ "Stopwatch" function and touch the C symbol.

## Cooking time

If you set a cooking time for your meal, the appliance switches off heating automatically after the selected time.

You can set a cooking time from 1 minute to 23 hours 59 minutes.

### Setting a cooking time

You have set the heating mode and temperature and you have placed your dish in the oven.

- 1 Touch the ⌚ symbol.
- 2 Use ▶ to select the ⌚ "Cooking time" function.

- 3 Set the desired cooking time using the rotary selector.



- 4 Press ▶ to start.

The appliance starts. The timer menu is closed. The settings for temperature, heating mode, elapsing time and cooking time end are shown in the display.

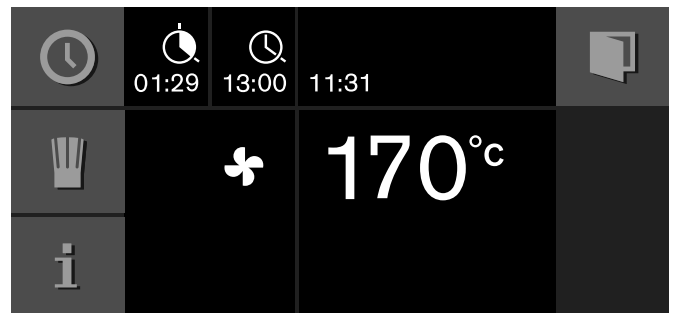

During the last minute of the cooking time the remaining time is displayed in an enlarged format.

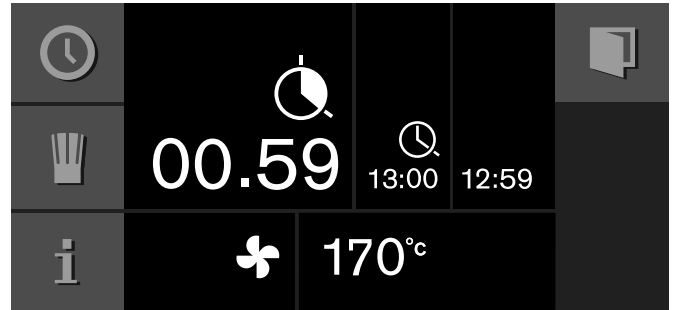

The appliance switches off after the cooking time has elapsed. The ⌚ symbol flashes and a signal sounds. The signal stops when you touch the ✓ symbol, open the appliance door, or switch the function selector to 0.

### Changing the cooking time:

Call up the timer menu. Use ▶ to select the ⌚ "Cooking time" function. Change the cooking time using the rotary selector. Press ▶ to start.

### Clearing the cooking time:

Call up the timer menu. Use ▶ to select the ⌚ "Cooking time" function. Clear the cooking time with C. Return to normal operation with X.

### Cancelling the entire operation:

Set the function selector to 0.

**Note:** You can also change the heating mode and temperature during the cooking time.

## End of cooking time

You can delay the cooking time end to a later time.

Example: it is 14:00. The dish requires a cooking time of 40 minutes. You want it to be ready at 15:30.

Enter the cooking time and delay the cooking time end until 15:30. The electronics system calculates the start time. The appliance starts automatically at 14:50 and switches off at 15:30.

Bear in mind that food which spoils easily should not be left in the cooking compartment for too long.

### Delaying the cooking time end

You have set the heating mode, temperature and cooking time.

- 1 Touch the ⌚ symbol.
- 2 Use ➤ to select the ⌚ "Cooking time end" function.



- 3 Set the desired cooking time end using the rotary selector.
- 4 Press ➤ to start.



The appliance switches to standby. The heating mode, temperature, cooking time and cooking time end appear in the display. The appliance starts at the calculated time and switches off automatically when the cooking time has elapsed.

**Note:** If the ⌚ symbol flashes: You have not set the cooking time. Always set the cooking time first.

Once the cooking time has elapsed, the appliance switches off. The ⌚ symbol flashes and an audible signal sounds. The signal stops early if you touch the ✓ symbol, open the appliance door, or set the function selector to 0.

### To change the cooking time end:

Call up the timer menu. Use ➤ to select the ⌚ "Cooking time end" function. Set the desired cooking time end using the rotary selector. Press ➤ to start.

### To terminate the whole procedure:

Set the function selector to 0.

## Long-term timer



With this function, the appliance maintains a temperature between 50 and 230 °C with the "Hot air" heating function.

You can keep food warm for up to 74 hours without having to switch the appliance on or off.







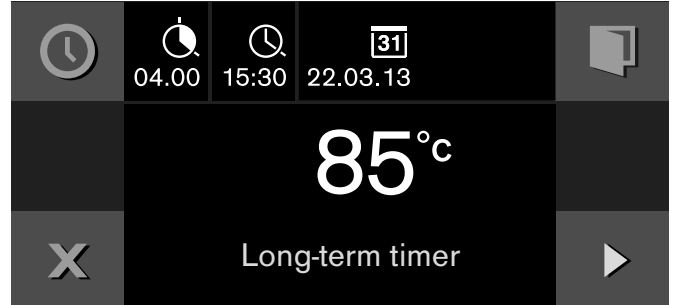

Bear in mind that food which spoils easily should not be left in the oven for too long.

**Note:** You must set the long-term timer to "available" in the basic settings (refer to the Basic settings section).

## Setting the long-term timer

- 1 Set the function selector to .
- 2 Touch the  symbol.  
The default value 24 hrs at 85 °C appears in the display. Press  to start  
-or-  
Change the cooking time, the cooking time end and the switch-off date.



- 3 Changing the cooking time :  
Touch the  symbol. Set the required cooking time using the rotary selector.
- 4 Changing the cooking time end :  
Touch the  symbol. Set the required cooking time end using the rotary selector.
- 5 Changing the switch-off date :  
Touch the  symbol. Set the required switch-off date with the rotary selector. Confirm with .
- 6 Changing the temperature:  
Set the required temperature with the rotary selector.
- 7 Press  to start.

The appliance starts.  and the temperature appear in the display.

The oven and display lighting are switched off. The control panel is locked; no key tone sounds when you touch the touch keys.

Once the set time has elapsed, the appliance stops heating. Turn the function selector to **0**.

### Switching off:



To end the process, turn the function selector to **0**.

## Individual recipes

It is possible to save up to 50 individual recipes. You can record a recipe. These recipes can be given a name so that they can be called up quickly and conveniently when required.

### Recording a recipe

It is possible to consecutively set up to 5 phases and to record at the same time.

- 1 Select the required heating mode using the function selector.  
The  symbol is displayed.
- 2 Touch the  symbol.
- 3 Select a free memory location by turning the rotary selector.
- 4 Touch the  symbol.

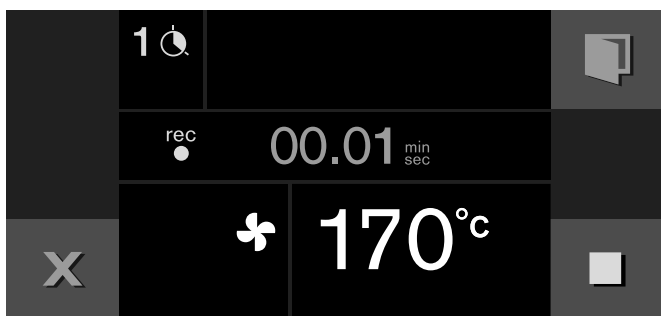



- 5 Select the required temperature using the rotary selector.
- 6 The cooking time is recorded.
- 7 To record another phase:  
Select the required heating mode using the function selector. Set the temperature using the rotary selector. This begins a new phase.
- 8 If the dish has achieved the desired cooking result, touch the  symbol to finish the recipe.
- 9 Enter the name in "ABC" (refer to the Entering names section).

#### Notes





- Recording of a phase starts only once the selected temperature has been reached.
- The minimum duration of each phase is 1 minute.
- During the first minute of a new phase it is possible to change the heating mode or the temperature.

#### Set a core temperature for a phase:





Connect the core temperature probe to the socket in the oven. Set the heating mode and the temperature. Touch the  symbol. Select the core temperature using the rotary selector and touch  to confirm.

## Programming a recipe

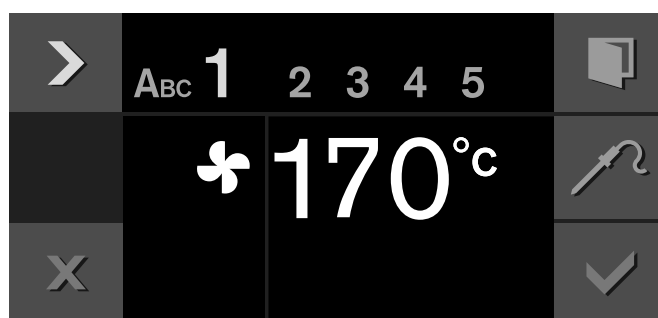

You can programme and save up to 5 preparation phases.

- 1 Turn the function selector to the desired type of heating. Turn the rotary selector to set the desired temperature.  
The  symbol is displayed.
- 2 Touch the  symbol.
- 3 Use the rotary selector to select a free memory location.
- 4 Touch the  symbol.
- 5 Enter the name in "ABC" (see chapter Entering names).
- 6 Use the  symbol to select the first phase.  
The initial type of heating and temperature is displayed. You can change the type of heating and the temperature by using the rotary selectors.



- 7 Use the  symbol to select the time allocation.
- 8 Turn the rotary selector to set the required cooking time.
- 9 Use the  symbol to select the next phase.  
- or -  
If preparation is complete, finish making entries.
- 10 Save with .  
- or -  
Cancel with  and exit the menu.

#### Setting the core temperature for a phase:

Use the  symbol to select the next phase. Set the type of heating and temperature. Touch the  symbol. Use the rotary selector to set the desired core temperature and confirm with .

**Note:** Cooking time can not be set for phases with a programmed core temperature.

## Entering names

- 1 Enter the name of the recipe in "ABC".

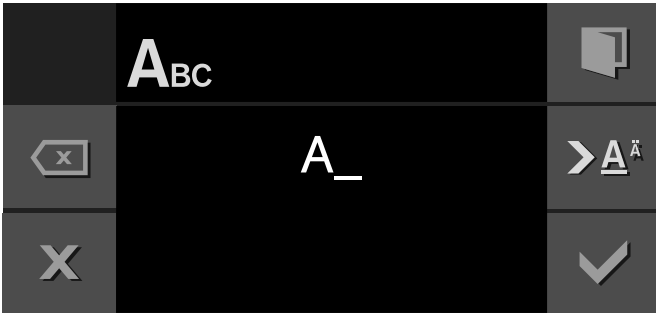

Rotary selector	Select letters A new word always begins with a capital letter.
➤ Â	Press briefly: moves the cursor right Press and hold: shifts to umlauts and special characters Press twice: adds a line break
➤ ä	Press briefly: moves the cursor right Press and hold: shifts to normal characters Press twice: adds a line break
⊞	Deletes letters

- 2 Save with ✓.  
- or -  
Cancel with X and exit the menu .

**Note:** For entering a name, Latin characters, certain special characters and numbers are available.

## Starting recipes

- 1 Set the function selector to any heating mode.  
The 🍷 symbol is displayed.
- 2 Touch the 🍷 symbol. Use the rotary selector to select the required recipe.
- 3 Press ▶ to start.  
Operation starts. The cooking time starts counting down in the display.  
The settings for each phase are shown in the display.

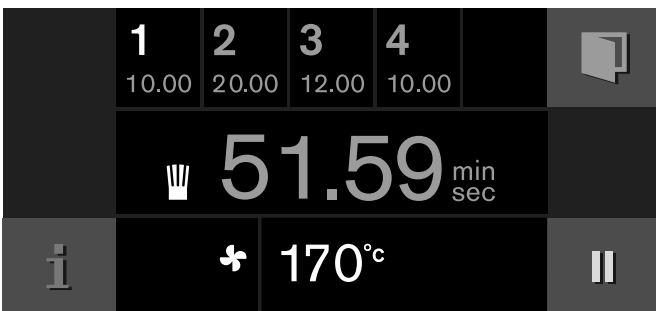

## Notes

- The cooking time does not start counting down until the appliance has reached the set temperature.
- You can use the rotary selector to change the temperature while the recipe is in progress. This does not change the saved recipe.

## Change recipe

You can change the settings of a recorded or programmed recipe.

- 1 Turn the function selector to the any type of heating.  
The 🍷 symbol is displayed.
- 2 Touch the 🍷 symbol.
- 3 Use the rotary selector to select the desired recipe.
- 4 Touch the \\_ symbol.
- 5 Use the ➤ symbol to select the desired phase.  
The programmed type of heating, temperature and cooking time are displayed. You can use the rotary selector or function selector to change the settings.
- 6 Save with ✓.  
- or -  
Cancel with X and exit the menu.

## Deleting recipes

- 1 Set the function selector to any type of heating.  
The 🍷 symbol is displayed.
- 2 Touch the 🍷 symbol.
- 3 Use the rotary selector to select the desired recipe.
- 4 Delete the recipe with C.
- 5 Confirm with ✓.

---

## Core temperature probe

---

The core temperature probe enables exact cooking to the spot. It measures the temperature inside the food being cooked. Automatic switching off when the desired core temperature is reached ensures that each food is cooked precisely.

Use the included core temperature probe only. You can purchase one as a spare part from after-sales service or in the online shop.

The core temperature probe can be damaged at temperatures above 250°C. Therefore, only ever use it in your oven up to a temperature of 230°C.

Always remove the core temperature probe from the oven after use. Never store it in the oven.

After every use, clean the core temperature probe with a moist cloth. Do not wash it in a dishwasher!

### **⚠ Risk of electric shock!**

The insulation of an incompatible meat probe may be damaged. Only use the meat probe which is recommended for this appliance.

### **⚠ Risk of burns!**

The cooking interior and the core temperature probe become very hot. Use oven mitts to plug and unplug the core temperature probe.

## Inserting the core temperature probe in the food to be cooked

Insert the core temperature probe in the food to be cooked before you place it in the cooking interior.

Insert the metal tip at the thickest point in the food to be cooked. Make sure that the end of the tip is approximately in the centre. It must not be placed in the fat and must not touch any cookware or bones.



If there are several pieces, insert the core temperature probe in the middle of the thickest piece.

Insert the core temperature probe completely, if possible.

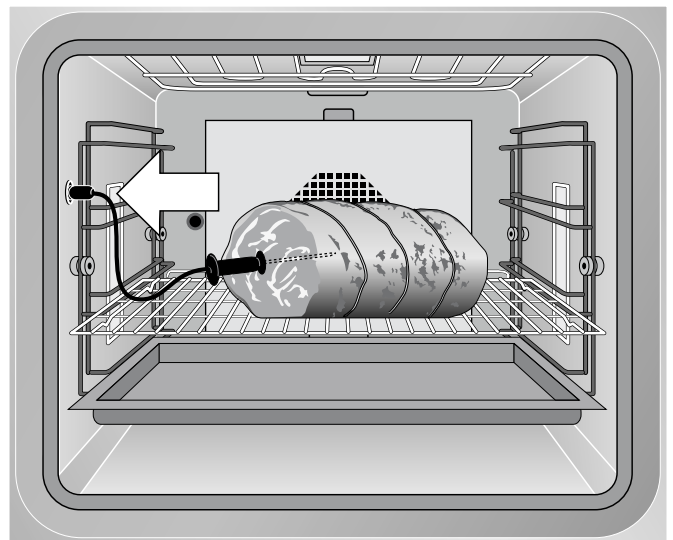
In the case of poultry, make sure that the tip of the core temperature probe is not in the cavity in the centre, but in the meat between the belly and upper leg.



## Setting the core temperature

- 1 Insert food into the oven interior with the core temperature probe inserted. Insert the core temperature probe in the socket in the oven interior and close the appliance door.  
Do not jam the core temperature probe's cable!  and the current core temperature appear in the display.
- 2 Set the function selector to the required heating mode.
- 3 Set the oven interior temperature with the rotary selector.
- 4 Touch the  symbol. With the rotary selector, set the required core temperature and confirm it with .  
The set core temperature must be higher than the current core temperature.

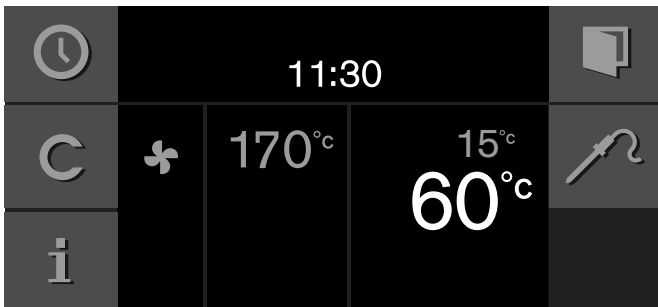



- 5 The appliance heats with the set heating mode. The current core temperature is displayed and, under it, the set core temperature. You can change the set core temperature at any time.

A signal sounds when the set core temperature in the food has been reached. The cooking mode is ended automatically. Confirm with  and turn the function selector to **0**.

## Notes

- The measurable range is 15 °C to 99 °C. Outside the measurable area, "--°C" is displayed for the current core temperature.
- If you leave food in the cooking compartment for some time after cooking, the core temperature continues to rise somewhat due to the residual heat in the cooking compartment.
- If you set the core temperature probe and the cooking timer at the same time, the appliance switches off whichever programme reaches the entered value first.

### Changing the set core temperature:

Touch the  symbol. Use the rotary selector to change the set core temperature for the food and confirm with .

### Deleting the set core temperature:

Touch the  symbol. Delete the set core temperature with **C**. The appliance continues heating in normal cooking operation.



## Core temperature guidelines

Use chilled food only, not frozen food. The details given in the table are guidelines. Results depend on the quality and composition of the food.

For hygiene reasons, critical foodstuffs such as fish and game should reach a core temperature of 62 – 70 °C; for poultry and minced meat this should be as high as 80 – 85 °C.

Food	Core temperature guideline
<b>Beef</b>	
Sirloin, tenderloin, entrecôte	
very rare	45 – 47 °C
rare	50 – 52 °C
medium	58 – 60 °C
well-done	70 – 75 °C
Joint of beef	80 – 85 °C
<b>Pork</b>	
Joint of pork	72 – 80 °C
Loin of pork	
medium	65 – 70 °C
well-done	75 °C
Meat loaf	85 °C
Fillet of pork	65 – 70 °C
<b>Veal</b>	
Joint of veal, well-done	75 – 80 °C
Breast of veal, stuffed	75 – 80 °C
Saddle of veal	
medium	58 – 60 °C
well-done	65 – 70 °C
Fillet of veal	
rare	50 – 52 °C
medium	58 – 60 °C
well-done	70 – 75 °C
<b>Game</b>	
Saddle of venison	60 – 70 °C
Leg of roe venison	70 – 75 °C
Venison loin steaks	65 – 70 °C
Saddle of hare or rabbit	65 – 70 °C

Food	Core temperature guideline
<b>Poultry</b>	
Chicken	85 °C
Guinea fowl	75 – 80 °C
Goose, turkey, duck	80 – 85 °C
Duck breast	
medium	55 – 60 °C
well-done	70 – 80 °C
Ostrich steak	60 – 65 °C
<b>Lamb</b>	
Leg of lamb	
medium	60 – 65 °C
well-done	70 – 80 °C
Saddle of lamb	
medium	55 – 60 °C
well-done	65 – 75 °C
<b>Mutton</b>	
Leg of mutton	
medium	70 – 75 °C
well-done	80 – 85 °C
Saddle of mutton	
medium	70 – 75 °C
well-done	80 °C
<b>Fish</b>	
Fillet	62 – 65 °C
Whole	65 °C
Terrine	62 – 65 °C
<b>Miscellaneous</b>	
Bread	90 °C
Paté	72 – 75 °C
Terrine	60 – 70 °C
Foie gras	45 °C

## Rotisserie spit

Use the rotisserie spit to grill large roasts or poultry. Grilling with the rotisserie spit produces a crispy crust and even browning all-round.

You can use the rotisserie spit in all heating modes. You get the best results in the "full surface grill" or "top heat" modes.

### Caution!

Do not use the temperature probe in combination with the rotisserie spit.

## Preparation

- 1 Push both spit holders in the fittings on the grill tray. The rotary drive is on the left.
- 2 Slide the right retaining clip onto the spit and tighten the screw.
- 3 Place the food you want to prepare on the rotisserie spit. Secure protruding parts (e.g. wings) to make sure they do not touch the grill heating element.

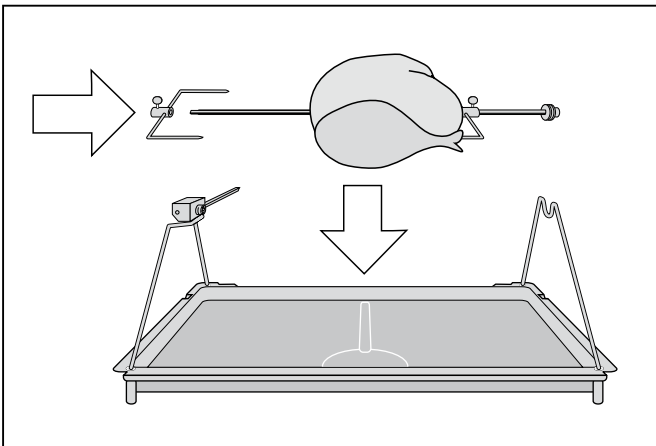

- 4 Slide the left retaining clip onto the spit and tighten the screw.
- 5 Place the spit onto the spit holders. Insert the square edge into the drive.

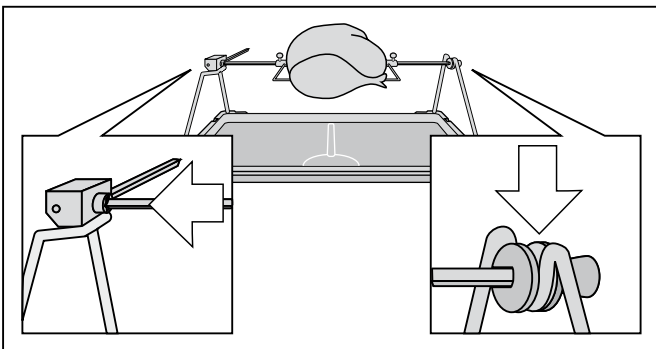

- 6 Insert the grill tray and the rotisserie spit on the lowest level of the oven. The drive shaft has to engage into the opening on the back of the oven interior.

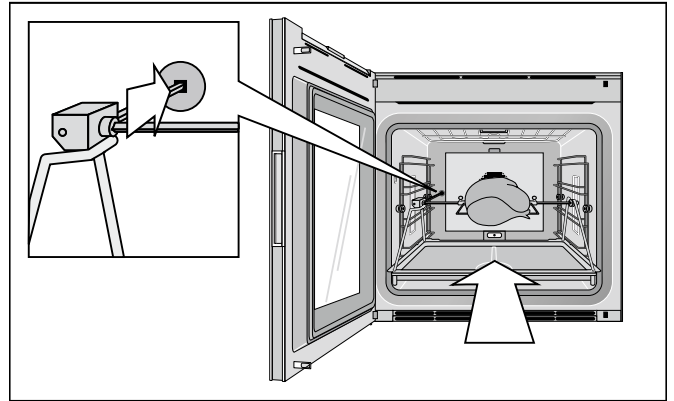

## Switching on the rotisserie spit

- 1 Set the required temperature and heating mode.
- 2 Touch the  symbol. The rotisserie spit begins to turn.



## Switching off the rotisserie spit

- 1 Touch the  symbol. The rotisserie spit's drive stops.
- 2 Switch off the oven with the rotary selector.
- 3 Take out the grill tray with the rotisserie spit and place them on a stable, heat-resistant surface.

### Risk of burns!

Use an oven glove to remove the grill tray.

- 4 Screw on the handle at the side to remove the rotisserie spit.

### Notes

- Use the rotisserie spit at oven temperatures up to 250°C only.
- Do not clean the drive part of the rotisserie spit in a dishwasher.

---

## Roasting function

---

Only when set to the "Roaster function" heating type: In the pre-roast stage, the oven heats up at full capacity for approx. 3 minutes. You can use this function to sear steaks, for example.

Touch the **»»** symbol. The pre-roast stage starts. You can also set the pre-roast stage several times consecutively.

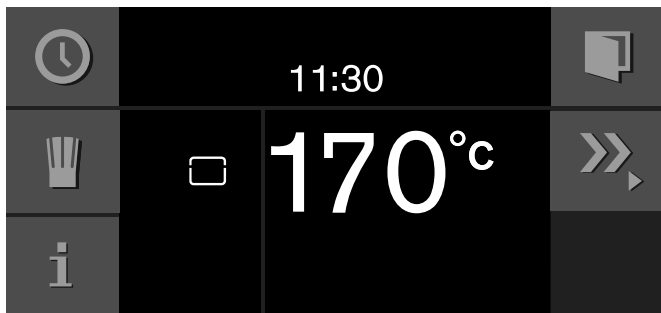

To end the pre-roast stage early, touch the **»»** symbol.

---

## Child lock

---

The appliance has a childproof lock to prevent children operating it accidentally.

### Notes

- You need to set the childproof lock to "available" in the basic settings (see section entitled 'Basic settings').
- If there is a power cut after the childproof lock has been activated, the childproof lock may be off when the power comes back on again.

## Activate the child lock

### Prerequisite:

The function selector is set to **0**.

Touch and hold the **🔒** symbol for at least 6 seconds.

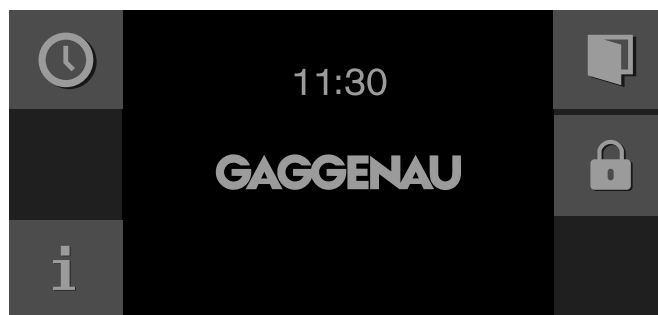

The child lock is activated. The standby screen appears. The **🔒** symbol is shown at the top of the display.

## Deactivating the child lock

### Prerequisite:

The function selector is set to **0**.

Touch and hold the **🔓** symbol for at least 6 seconds.

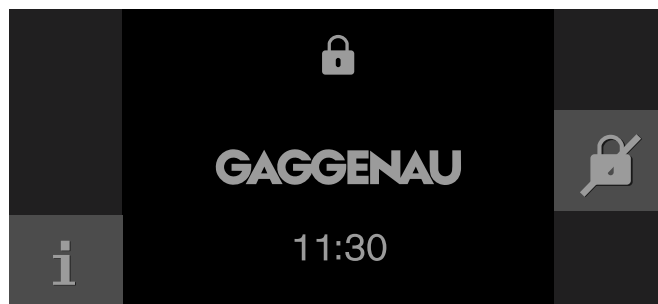

The child lock is deactivated. You can set the appliance as usual.













## Basic settings









Your appliance can be individually adjusted in the basic settings.

- 1 Turn the function selector to **S**.
- 2 Select "Basic settings" using the rotary selector.
- 3 Touch the ✓ symbol.
- 4 Turn the rotary selector to select the required basic setting.

- 5 Touch the \\_ symbol.
- 6 Set the basic setting using the rotary selector.
- 7 Save with ✓ or cancel with X and exit the current basic setting.
- 8 Turn the function selector to **0** to exit the basic settings menu.

The changes are saved.

	Basic setting	Permitted settings	Explanation
	Brightness	Level 1, 2, 3, 4, 5*, 6, 7, 8	Sets the display brightness
	Standby screen	On*/Off - Clock - Clock + GAGGENAU logo* - Date - Date + GAGGENAU logo - Clock + date - Clock + date + GAGGENAU logo	Appearance of the standby screen. Off: No display. Use this setting to reduce the standby consumption of your appliance. On: Several displays can be set, confirm "On" with ✓ and use the rotary selector to select the desired display. The selection is displayed.
	Display	Reduced*/Standard	If the 'Reduced' setting has been selected, only the most important information will be shown on the display after a short time.
	Touch field colour	Grey* / White	Selects the colour of the symbols on the touch fields
	Touch field tone	Tone 1* / Tone 2 / Off	Selects an audible signal for when a touch field is touched
	Touch field tone volume	Level 1, 2, 3, 4, 5*, 6, 7, 8	Sets the volume of the touch field tone
	Heating-up time/audible signal	Heating up with audible signal Rapid heat-up with audible signal* Heating up without audible signal Rapid heat-up without audible signal	With the heating-up function, the audible signal sounds when the desired temperature is reached. With the "Rapid heat-up" function, the desired temperature is reached particularly quickly.
	Signal volume	Level 1, 2, 3, 4, 5*, 6, 7, 8	Sets the volume of the audible signal
	Time format	AM/PM / 24 h*	Display the clock in 24 or 12-hour format
	Time	Current time	Setting the clock
	Clock change	Manual* / Automatic	Automatically changes the clock to daylight-savings time. If automatic: Setting the month, day and week for when the time should be changed over. To be set for both summer and winter time.
	Date format	D.M.Y* D/M/Y M/D/Y	Sets the date format

	Date	Current date	Sets the date. You can switch between year/month/day using the symbol ➤.
	Temperature format	°C* / °F	Sets the temperature unit
	Language	German* / French / Italian / Spanish / Portuguese / Dutch / Danish / Swedish / Norwegian / Finnish / Greek / Turkish / Russian / Polish / Czech / Slovenian / Slovakian / Arabic / Hebrew / Japanese / Korean / Thai / Chinese / English US / English	Select language for text display <b>Note:</b> If the language is changed, the system restarts. This takes a few seconds. The basic settings menu is also closed.
	Factory settings	Restore appliance to factory settings	Confirm the question "Delete all individual settings made and reset to factory settings?" by pressing ✓ or cancel by pressing ✕. <b>Note:</b> Individual recipes will also be deleted if the appliance is restored to factory settings. After restoring factory settings, the "Initial settings" menu is displayed.
	Demo mode	On / Off*	Only for presentation purposes. The appliance does not heat up in demo mode, all other functions are available. The "Off" setting must be activated for normal operation. The setting is only possible in the first 3 minutes after connecting the appliance to the mains.
	Long-term timer	Not available*/Available	Available: The long-term timer can be set; see section entitled 'Long-term timer'.
	Door lock	Off* / On	The door lock prevents unintentional opening of the appliance door. When "On" is set, you must touch the  symbol for several seconds before the door opens.
	Childproof lock	Not available*/Available	Available: The childproof lock can be activated (see section entitled 'Childproof lock').

\* Factory setting

## Cleaning and maintenance

With thorough care and cleaning your appliance will retain its looks and remain in good order. We will explain here how you should care for and clean your appliance correctly.

### Risk of burns!

The appliance becomes very hot. Never touch the interior surfaces of the cooking compartment or the heating elements. Always allow the appliance to cool down. Keep children at a safe distance.

### Risk of electric shock!

Do not use any high-pressure cleaners or steam cleaners, which can result in an electric shock.

### Risk of injury!

Scratched glass in the appliance door may develop into a crack. Do not use a glass scraper, sharp or abrasive cleaning aids or detergents.

## Cleaning agents

Pay attention to the information in the table to avoid damaging the various surfaces by incorrect cleaning agents.

Do not use

- harsh or abrasive cleaning agents
- metal or glass scrapers to clean the glass on the appliance door
- metal or glass scrapers to clean the door seal
- hard abrasive pads or cleaning sponges

Thoroughly rinse out new sponge cloths before use.

Area	Cleaning agent
Door panels	Glass cleaner: Clean with a soft cloth or a microfibre cloth. Do not use a glass scraper.
Display	Wipe down using a microfibre cloth or a slightly damp cloth. Do not wipe with a wet cloth.
Stainless steel	Hot soapy water: Clean using a dish cloth and then dry with a soft cloth. Remove flecks of limescale, grease, starch and albumin (e.g. egg white) immediately. Corrosion can form under these patches or splashes. Special stainless-steel cleaning agents are available from the after-sales service or from specialist retailers.
Aluminium	Clean with a mild window cleaning agent. Using a window cloth or a non-fluffing microfibre cloth, wipe over the surfaces lightly in a horizontal direction.

Area	Cleaning agent
Cooking compartment	Hot soapy water: Clean using a dish cloth and then dry with a soft cloth.
Very dirty cooking compartment	Oven cleaner gel (order number 00463582 from the after-sales service or from the online shop). <b>Please note:</b> <ul style="list-style-type: none"> <li>● Must not come into contact with the door seal.</li> <li>● Maximum application time is 12 hours.</li> <li>● Do not use on warm surfaces.</li> <li>● Always rinse using water.</li> <li>● Follow the manufacturer's instructions.</li> </ul>
Glass cover for the cooking compartment light	Hot soapy water: Clean with a dish cloth.
Door seal Do not remove.	Hot soapy water: Clean with a dish cloth, do not scrub. Do not use a metal or glass scraper for cleaning.
Core temperature probe	Wipe with a damp cloth. Do not clean in the dishwasher.
Accessories	Hot soapy water: Soak and clean with a dish cloth or brush.
Slide-in racks	Dishwasher, see section "Removing slide-in racks"
Telescopic shelf (optional accessory)	Hot soapy water: Clean with a dish cloth or a brush. Do not soak or clean in the dishwasher.
Baking stone (optional accessory)	Remove burnt-on residues with a brush. Never clean the baking stone when it is wet.

### Microfibre cloth

The honeycomb microfibre cloth is particularly suitable for cleaning sensitive surfaces such as glass, glass ceramic, stainless steel or aluminium (part number 00460770 from our after-sales service or from our online shop). It removes liquid and greasy deposits in one go.

## Removing slide-in racks

You can remove the slide-in racks for cleaning.

### Removing slide-in racks

- 1 Place a dish cloth in the oven interior to protect the enamel against scratches.
- 2 Undo the knurled nuts (Figure A).
- 3 Detach the slide-in racks (Fig. B).

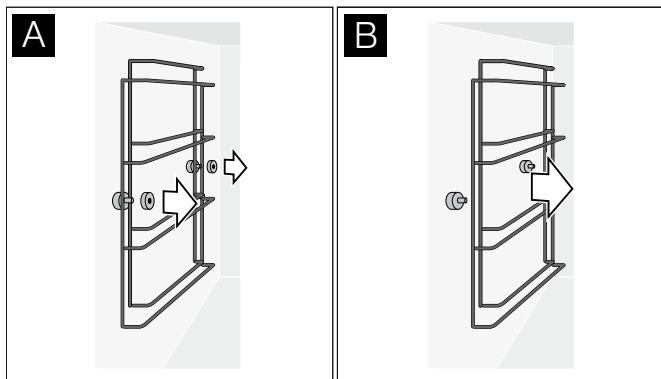

You can clean the slide-in racks in a dishwasher.

### Hooking in slide-in racks

- 1 Fit slide-in racks the right way round: with the longer side pointing up. The left and right-hand racks are identical.
- 2 Tighten the knurled nuts.

## Pyrolytic cleaning (self-cleaning)

During self-cleaning, the oven heats up to 485°C. Thus, remainders from roasting, grilling or baking are burnt up and all you have to do is wipe the ash out of the interior.

Pyrolytic cleaning takes three hours. You can move the pyrolytic cleaning switch-off time (for example, if you would like it to run at night).

### ⚠ Risk of fire!

Loose food residues, grease and meat juices may catch fire during pyrolytic cleaning. Remove coarse dirt from the cooking compartment and from the accessories before every pyrolytic cleaning cycle.

### ⚠ Risk of fire!

The appliance will become very hot on the outside during the pyrolytic cleaning cycle. Never hang combustible objects, e.g. tea towels, on the door handle. Do not place anything against the front of the oven. Keep children at a safe distance.

### ⚠ Risk of serious damage to health!

The appliance will become very hot during the pyrolytic cleaning cycle. The non-stick coating on baking trays and tins is destroyed and noxious gases are released. Never let non-stick baking trays and tins go through the pyrolytic cleaning cycle. Only enamelled accessories may be cleaned at the same time.





## Preparing pyrolytic self-cleaning

### Caution!

Fire risk! Loose food remainders, fat and roast juice can catch fire. Wipe out the oven interior with a moist cloth.

- Remove coarse soiling and food remainders from the oven.
- Clean the door seals manually, the inside of the door and the glass pane because the pyrolytic cleaning process does not clean these parts.
- Remove all loose interior parts from the oven interior. The slide-in racks are pyrolysis-proof. There must be no objects left in the interior.
- Close the oven door.

## Starting pyrolytic self-cleaning

- 1 Set the function selector to **S**.
- 2 The + symbol is displayed. Confirm with .
- 3 The switch-off time, when pyrolytic self-cleaning will be finished, is displayed. If required, move the switch-off time with the rotary selector. Confirm with .
- 4 Remove all accessories and coarse soiling from the oven interior. Confirm with .
- 5 Press  to start. The cleaning time elapses on the display. If the switch-off time has been shifted, the time up to the start of pyrolytic self-cleaning elapses in the display. The lamp in the oven interior stays off.

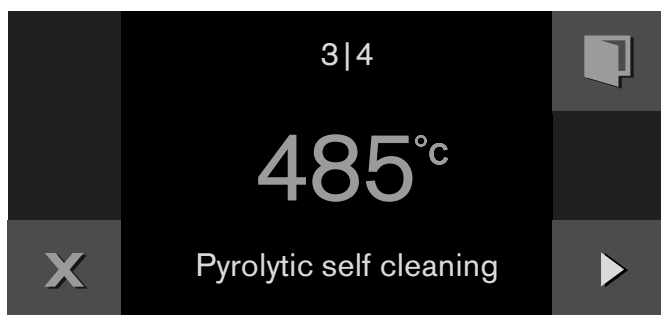

A signal sounds after 3 hours. A message appears in the display. Once the appliance has cooled down, wipe the remaining ash out of the interior with a moist cloth.

**Note:** For your safety, the oven door is locked. When cooling down, the door lock is released when the temperature drops below 200°C.

## Cleaning accessories with pyrolytic self-cleaning

Gaggenau baking trays and grill trays are coated with pyrolysis-proof enamel. To arrive at an optimum cleaning result, you are nevertheless advised to remove all accessories from the oven before the pyrolytic cleaning process. Only this will ensure optimum heat distribution.

If you would like to remove burnt-in residues from your baking tray or your grill tray with pyrolytic self-cleaning, it is imperative that you observe the following notes:

### Notes

- Remove extreme soiling, roast juice and food remainders before pyrolytic self-cleaning. Food remainders, grease or roast juice can catch fire during pyrolytic self-cleaning.
- Only ever insert one baking tray or one grill tray in the lowest shelf in the oven.
- Insert the baking tray or the grill tray fully.
- The wire rack, rotisserie spit, cast roaster, baking stone, core temperature probe or other accessories must not be cleaned by pyrolytic self-cleaning.



---



## Trouble shooting

---

Malfunctions often have simple explanations. Please read the following notes before calling the after-sales service.

### Risk of electric shock!

Incorrect repairs are dangerous. Repairs may only be carried out and damaged power cables replaced by one of our trained after-sales technicians. If the appliance is defective, unplug the appliance from the mains or switch off the circuit breaker in the fuse box. Contact the after-sales service.

Disruption	Possible cause	Solution
Appliance not working, no display	Plug not inserted	Connect the appliance to the electricity mains
	Power failure	Check whether other kitchen appliances are working
	Fuse defective	Check in the fuse box whether the fuse for the appliance is in working order
	Operating error	Switch off the fuse for the appliance in the fuse box and switch it on again after about 60 seconds
Appliance cannot be started	Appliance door is not quite closed	Close appliance door
The appliance is not working and the display does not respond.  appears on the display	Childproof lock activated	Deactivate the childproof lock (see section entitled 'Childproof lock')
Appliance switches off on its own	Safety shut-off: the appliance has not been operated for longer than 12 hours	Confirm the message with  , switch off the appliance and set it again.
Appliance does not heat up,  appears in the display	Appliance is in demo mode	Deactivate the demo mode in the basic settings
Error message "Exxx"		If an error message is displayed, turn the function selector to <b>0</b> ; if the display goes out, there was a non-recurring problem. If the error occurs repeatedly or the display remains on, please contact the after-sales service and inform them of the error code.

## Power cut

Your appliance can bridge a power cut of a few seconds. Operation continues.

If the power cut was for a longer period and the appliance was in operation, a message appears in the display. Operation is interrupted.

Set the function selector to **0**, then the appliance can be operated again as usual.

## Demo mode

The  symbol appears on the display when the appliance is in demo mode. The appliance will not heat up.

Briefly disconnect the appliance from the mains (switch off the household fuse or the circuit breaker in the fuse box). Then deactivate demo mode in the basic settings within 3 minutes (see section entitled 'Basic settings').

## Replacing the oven light bulb

The oven light bulbs can be replaced. Heat-resistant halogen bulbs can be obtained from the After-sales service or from a specialist retailer. Always use halogen bulbs of the same type.

- Bulb at the top: 60 W/230 V/G9
- Bulb at the side: 10 W/12 V/G4

### Risk of electric shock!

When replacing the cooking compartment bulb, the bulb socket contacts are live. Before replacing the bulb, unplug the appliance from the mains or switch off the circuit breaker in the fuse box.

**Note:** Always remove the new halogen bulb from the packaging using a dry cloth. This increases the service life of the bulb.

### Replacing the ceiling light

- 1 Loosen the screw on the lamp cover. Tilt down the lamp cover.
- 2 Pull out the bulb. Insert the new bulb.
- 3 Tilt the lamp cover up and screw it back on.
- 4 Switch the circuit breaker back on.

### Replacing the side light

- 1 Place a tea towel in the oven to prevent damage.
- 2 Pull out the shelf after undoing the knurled nuts.
- 3 Push the top mounting bracket back and remove the glass cover.
- 4 Pull out the bulb. Insert the new bulb.
- 5 Insert the glass cover under the bottom mounting bracket and press it down firmly on the top. The sloping edges of the glass cover must face to the interior of the oven.
- 6 Remove the tea towel.
- 7 Switch the circuit breaker back on.

### Replacing the glass cover

If the glass cover in the oven is damaged, it must be replaced. You can obtain covers from the after-sales service. Please supply your appliance's E number and FD number.

---

## After-sales service

---

Our after-sales service is there for you if your appliance needs to be repaired. We will always find an appropriate solution, also in order to avoid after-sales personnel having to make unnecessary visits.

### E number and FD number

When calling us, please give the full product number (E no.) and the production number (FD no.) so that we can provide you with the correct advice. The rating plate bearing these numbers can be found when you open the appliance door.

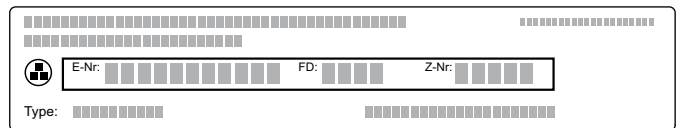

To save time, you can make a note of the number of your appliance and the telephone number of the after-sales service in the space below, should it be required.

---

**E no.**

**FD no.**

---

---

**After-sales service** 

---

Please note that a visit from an after-sales service engineer is not free of charge, even during the warranty period.

Please find the contact data of all countries in the enclosed customer service list.

### To book an engineer visit and product advice

**GB** 0344 892 8988  
Calls charged at local or mobile rate.

**IE** 01450 2655  
0.03 € per minute at peak.  
Off peak 0.0088 € per minute.

**AU** 1300 368 339

**NZ** 09 477 0492

Trust the expertise of the manufacturer, and rest assured that the repair will be carried out by trained service technicians using original spare parts for your domestic appliance.

## Settings table and tips

### Notes

- Always preheat the appliance. This will provide the best cooking results. The cooking times specified refer to a pre-heated appliance.
- The values specified are intended as a guide. The actual cooking time depends on the quality and temperature of the food before cooking, the weight and thickness of the food to be cooked.
- Temperature ranges are given in the tables. Start with the lowest temperature. A higher temperature can be selected next time, if required. A lower temperature results in more even browning.
- The values given refer to average quantities for four people. If you would like to prepare more food, you should allow for a longer cooking time.
- Use the cookware specified. If you use other cookware, cooking times may be longer or shorter.
- You can use any heat-resistant cookware. Place the cookware in the centre of the wire rack. For large roasts, you can also use the grill tray or glass dish.
- Do not place too many items close together on wire racks or baking trays. This is the only way to ensure optimal heat circulation.
- To prepare bulky food items, you can remove the side slide-in rack. Place the wire rack directly onto the bottom of the cooking compartment and place the food or roasting dish onto the wire rack. Do not place the food or roasting dish directly onto the enamel bottom of the cooking compartment.
- Open the door of the preheated oven for a short time only when placing food inside the cooking compartment.
- The values given for the level refer to the rack level (counting from the bottom) in appliances with four rack levels. The values in brackets refer to appliances with five rack levels.
- Once you have taken glass cookware out of the oven, set it down on a dry trivet or heat-proof mat; never set it down on a cold or wet surface. Otherwise, the glass may crack.
- Some operating modes are not available on all oven models or are only available as an optional accessory.

## Vegetables

- Oven-roasted or oven-baked vegetables are a good alternative to pan-fried vegetables. The different flavours become more concentrated and, because the vegetables are roasted, they have a very distinctive taste. In addition, very little fat is required to prepare the vegetables.
- Clean and prepare the vegetables and mix them with a little oil in a bowl. Place them in a heat-resistant baking dish or tin or in the glass dish/grill tray and spread them out evenly.
- Mix them thoroughly at least once during the cooking process. Once they are cooked, season them and sprinkle them with fresh herbs to taste.
- Vegetables are good as a hot or cold starter or vegetarian main course, or as an accompaniment to meat and fish.
- Use an ovenproof dish for small portions (for 2 - 3 people) and place it on the wire rack. If you use the glass dish/grill tray, the food will start to burn or dry out.
- In addition, always follow the manufacturer's instructions for pre-cooked and frozen products.

Dish	Accessories	Level	Temperature in °C	Heating function	Cooking time in min.	Comments
Vegetable kebabs	Wire rack + grill tray	3 (4)	220	~~~~~	24*	Shorten the wooden skewers or leave them to soak in water overnight to prevent them from charring. Recipe tip: Peppers, onions, sweetcorn (pre-cooked), cherry tomatoes, courgette
Green asparagus, grilled	Glass dish/ grill tray	3 (4)	300	~~~~~	6 - 10*	Recipe tip: Season with onions, oil, vinegar, salt and pepper.
Root vegetables	Glass dish/ grill tray	3 (4)	200	🍀 / 🍀 <sup>a</sup>	30*	Recipe tip: Season carrots, celery, swede and beetroot with oil, garlic, salt and pepper.
		3 (4)	250	~~~~~	15 - 20*	

\* Turn food after half the cooking time has elapsed.

Dish	Accessories	Level	Temperature in °C	Heating function	Cooking time in min.	Comments
Sliced pumpkin	Glass dish/ grill tray	3 (4)	200	✿	30*	Recipe tip: Season with oil, garlic, ginger, cumin, salt and pepper.
Antipasti	Glass dish/ grill tray	3 (4)	200	✿	30*	Recipe tip: Drizzle balsamic vinegar over the vegetables whilst they are still hot, and season them.
		3 (4)	250	~~~~	15 - 20*	
Escalivada (Mediterranean oven-grilled vegetables)	Ovenproof dish	4 (5)	250	~~~~	15*	Recipe tip: Aubergines, onions, tomatoes, peppers, oil. Delicious hot or cold.
Ratatouille	Glass dish/ grill tray	3 (4)	200	---	30 - 40*	Recipe tip: Sprinkle with parmesan just before serving.
Oven-roasted tomatoes	Ovenproof dish	2 (3)	120	✿ / ✿ <sup>e</sup>	60	Recipe tip: Place cherry tomatoes or sliced tomatoes, rosemary and garlic into the baking dish and drizzle with oil and a little honey.  If you wish, you can blanch the tomatoes and skin them before roasting them in the oven.
Chicory	Ovenproof dish	2 (3)	180	✿ / ✿ <sup>e</sup>	25 - 30	Recipe tip: Halve, season, wrap in boiled ham, pour cream and béchamel sauce over the top and sprinkle with cheese.
		2 (3)	200	---	25 - 30	
Stuffed peppers, vegetarian	Ovenproof dish/roasting dish	2 (3)	200	---	30 - 34	Recipe tip: Stuff with boiled rice, soft wheat or lentils and onions, cheese, herbs and seasoning/spices.
Stuffed courgettes, vegetarian	Glass dish/ grill tray	2 (3)	180	✿	25	Recipe tip: Stuff with grated carrot, spring onion, goats' cheese, garlic, thyme, salt and pepper and sprinkle with parmesan.
Vegetable bake	Ovenproof dish	2 (3)	200	---	20 - 30	Pre-cooking/blanching vegetables and other ingredients.
Veggie burgers, frozen	Baking tray + grease-proof paper	2 (3)	220	✿ / ✿ <sup>e</sup>	12 - 15*	



















\* Turn food after half the cooking time has elapsed.

## Side dishes and meals

- The best known oven-cooked side dishes are potato-based, such as potato gratin. However, you can also obtain excellent results when oven-cooking side dishes that are normally pan-fried, e.g. potato fritters and fried potatoes. The advantages of this preparation method: You can prepare relatively large quantities of food at the same time, the cooking smells do not spread so far in the room, and the food can be prepared using less fat.
- Another highly versatile oven-cooked side dish is cheese. It is a very good addition to vegetarian dishes in particular; depending on the preparation method, you can also serve cheese as a starter or finger food.
- Grilled dishes such as bakes and gratins are particularly well suited to being prepared in the oven. Dishes with a dough or pastry base, e.g. pizza and savoury flan, and egg dishes with a filling, e.g. tortilla, are also suitable.
- Use a heat-resistant baking dish or tin for small portions (2 - 3 people) and place it on the wire rack. If you use the glass dish/grill tray, small portions will start to burn or dry out.
- In addition, always follow the manufacturer's instructions for pre-cooked and frozen products.

Dish	Accessories	Level	Temperature in °C	Heating function	Cooking time in min.	Comments
<b>Side dishes</b>						
Potatoes on a bed of salt	Ovenproof dish	2 (3)	200	---	40 - 60*	Fill the ovenproof dish with 2 cm of sea salt. Place small potatoes into the dish with their skins on and brush them with olive oil.
Potato pieces	Baking tray + grease-proof paper	2 (3)	200	✿	15*	Recipe tip: Chop the potatoes and season them with olive oil, paprika and salt.
Chips, fresh	Baking tray + grease-proof paper	3 (4)	200	✿	15 - 20*	Recipe tip: Cover with a little oil, and after cooking, season with salt and paprika or curry powder.
Chips, frozen	Baking tray + grease-proof paper	3 (4)	220	✿	14*	
Potato gratin	Ovenproof dish	2 (3)	160	✿	45 - 50	
Potato fritter	Baking tray	2 (3)	175	✿	20 - 30*	Oil the baking tray liberally, squeeze out the excess liquid from the potato fritter mixture and brush with a little oil. Turn once.
		2 (3)	200	---	20 - 30*	
Roast potatoes	Grill tray	2 (3)	180	✿	30 - 45*	Low-fat preparation. Spread evenly across the grill tray and mix thoroughly several times.
Goats' cheese in a bacon blanket	Glass dish/ baking tray	2 (3)	220	✿	8 - 10	Either goats' cheese or goats' camembert can be used.
		3 (4)	220	~~~~	8 - 10	
Goats' cheese with honey	Glass dish/ baking tray	2 (3)	200	✿	8	Recipe tip: Drizzle lavender honey over the goats' cheese or goats' camembert and sprinkle with pine nuts.
		3 (4)	200	~~~~	8	
Baked camembert, coated with breadcrumbs, fresh	Baking tray + grease-proof paper	2 (3)	180	✿ / ✿ <sup>e</sup>	15 - 20	Bake until the breadcrumb coating rises in the centre.
Baked camembert, coated with breadcrumbs, frozen	Baking tray + grease-proof paper	2 (3)	180	✿ / ✿ <sup>e</sup>	15 - 20	Bake until the breadcrumb coating rises in the centre.
		2 (3)	200	---	15	
Mozzarella sticks, frozen	Baking tray + grease-proof paper	2 (3)	180	✿ / ✿ <sup>e</sup>	10	

\* Turn food after half the cooking time has elapsed.

Dish	Accessories	Level	Temperature in °C	Heating function	Cooking time in min.	Comments
Feta cheese	Baking tray	2 (3)	250		12	Recipe tip: Place in a baking dish with oil, tomatoes, onions, garlic and rosemary and season with salt and pepper.
Oven-baked cheese, fresh	Baking tray	2 (3)	180		20	After 10 minutes, cut a cross into the soft cheese and break open. If possible, the baking dish should be not much larger than the cheese so that the cheese does not run.
<b>Dishes</b>						
Tortilla	Ovenproof dish	2 (3)	160		40	Recipe tip: With paprika, olives, onion, Serrano ham and Manchego cheese.
Farmers' omelette	Ovenproof dish	2 (3)	160		40	Recipe tip: With green and white asparagus; also with gravlax.
Frittata	Ovenproof dish	2 (3)	190		45 - 50	Recipe tip: With spinach, onion and prawns.
Enchiladas, grilled	Glass dish/ grill tray	2 (3)	200		15 - 20	
Lasagne	Ovenproof dish	2 (3)	175		40	Recipe tip: Traditional or vegetarian with grilled vegetables and buffalo mozzarella.
Macaroni cheese	Ovenproof dish	2 (3)	180 / 220		10 - 20	To obtain a crust on the cheese, increase the temperature to 220 °C after 10 minutes and leave to brown for a further 10 minutes.
Cheese spätzle (Swabian noodle dish)	Ovenproof dish	2 (3)	180 / 220		30	Gradually layer the freshly cooked spätzle in the baking dish, sprinkling each layer with cheese.  Once you have done this, top the dish with cheese and roasted onion, raise the temperature to 220 °C and cook for 5 minutes.
Spring rolls, frozen	Baking tray + grease-proof paper	2 (3)	225		18 - 20*	
Mini spring rolls, frozen	Baking tray + grease-proof paper	2 (3)	225		10*	
Pizza, fresh	Baking tray	2 (3)	230 - 250		10 - 15	Lightly oil the baking tray.
Pizza, pre-baked	Baking tray + grease-proof paper	2 (3)	230		6 - 8	
		2 (3)	230		6 - 8	
Pizza, frozen	Wire rack	2 (3)	200		11 - 13	
		2 (3)	220		11 - 13	
American pizza (thick base), frozen	Baking tray	2 (3)	200		20 - 24	No need to pre-heat.
Savoury flan, fresh	Baking tray	2 (3)	250		8 - 10	Recipe tip: Traditional or with goats' cheese, Parma ham, figs and spring onion.
Savoury flan, pre-baked	Baking tray + grease-proof paper	2 (3)	250		7	

\* Turn food after half the cooking time has elapsed.

Dish	Accessories	Level	Temperature in °C	Heating function	Cooking time in min.	Comments
Savoury flan, frozen	Wire rack	2 (3)	200	☼	10 - 12	
		2 (3)	230	---	8 - 10	
Quiche	Tart tin or dish	2 (3)	200	---	20 + 20	Pre-bake the base for 20 minutes, pour the mixture onto the base and then bake for a further 20 minutes.
Onion tart	Baking tray	2 (3)	200	---	30 - 40	

\* Turn food after half the cooking time has elapsed.

## Fish

- For food hygiene reasons, fish should have a core temperature of at least 62 - 70 °C after cooking. This is also the ideal cooking temperature.
- Do not season the fish with salt until it is fully cooked. This ensures that the natural flavour is maintained and that less water is drawn out of the fish.
- Use a small amount of oil to grease the wire rack or baking tray so that the fish does not stick to it.
- For fillets with skin: Place the fish on the rack or tray with the skin side up – this helps to hold the fish together and maintain its flavour.
- Shorten the wooden skewers or, before skewering the ingredients, leave the skewers to soak in water overnight to prevent them from charring.
- In addition, always follow the manufacturer's instructions for pre-cooked and frozen products.

Dish	Accessories	Level	Temperature in °C	Heating function	Cooking time in min.	Comments
Prawn kebabs, fresh	Wire rack + grill tray	3 (4)	180	~~~~~	10*	
Prawn kebabs, frozen	Wire rack + grill tray	3 (4)	180	~~~~~	12*	
Fish kebabs	Wire rack + grill tray	3 (4)	200	~~~~~	12*	Use firm types of fish, e.g. salmon, pollack, ocean perch and cod.
Trout, whole	Baking tray	3 (4)	200 - 220	~~~~~	16*	Recipe tip: Stuff with lemon, garlic and parsley.
Sea bream, whole	Wire rack + grill tray	3 (4)	200 - 220	~~~~~	20 - 25*	Recipe tip: Stuff with lemon, garlic and thyme, or use mint for a summery touch. Make a diagonal incision into the skin of the sea bream.
	Baking tray	3 (4)	175	☼	20 - 25*	
Salmon steak	Wire rack + grill tray	3 (4)	250	☼	10 - 12	Recipe tip: Marinate in a mixture of sweet lime, salt, pepper and garlic.
	Baking tray	2 (3)	200	☼	10 - 12	
Tuna steak	Baking tray	3 (4)	250	☼	8 - 10	Recipe tip: Season Asian-style with soy sauce, sesame oil, ginger, honey, garlic, chilli and coriander seeds.
Fish fingers, frozen	Baking tray + grease-proof paper	2 (3)	220	☼	15 - 17*	
Squid rings, frozen	Baking tray + grease-proof paper	2 (3)	220	---	8 - 12	

\* Turn food after half the cooking time has elapsed.

## Meat

- Use the core temperature probe so that you can monitor the core temperature more easily. Information and instructions, as well as optimal target temperatures, can be found in the section Core temperature probe.
- Leaving meat to rest: Leave the meat to rest for a further 10 - 15 minutes after cooking. This gives the meat a chance to "relax". The meat juices begin to circulate less, and when the meat is cut, less juice is lost. Large pieces of meat, e.g. joints, can be left to rest in the oven. Smaller pieces of meat, e.g. steaks, should be wrapped in aluminium foil and left to rest outside the oven.
- For small portions (2 - 3 people), it is a good idea to use a heat-resistant baking dish or tin so that the food does not begin to burn or dry out.
- Use the grill tray or roasting dish for a large joint of meat and for preparation methods that involve adding a lot of liquid to the joint.
- For best results, leave meat to marinate overnight and remove it before roasting or grilling, e.g. using the back of a knife or a spoon. Otherwise, the herbs and spices will burn.
- If the joint of meat has become too dark in colour and the skin is burnt in places, reduce the set temperature the next time you cook a joint and check the rack level.
- If the joint is cooked but the sauce is slightly burnt, use a smaller roasting dish the next time you cook a joint and add more liquid. If the sauce is too watery, use a larger roasting dish and add less liquid.

Dish	Accessories	Level	Temperature in °C	Heating function	Cooking time in min.	Comments
<b>Beef</b>						
Joint of beef (1.5 kg)	Glass dish/ grill tray	2 (3)	180	✿	90 - 120*	
Roast beef/sirloin steak (1 kg) – rare	Glass dish/ grill tray	2 (3)	230 / 180	✿	25 - 35**	Recipe tip: Delicious with Béarnaise sauce or cold cut with remoulade and roast potatoes.
– medium rare	Glass dish/ grill tray	2 (3)	230 / 180	✿	30 - 40**	
– well done	Glass dish/ grill tray	2 (3)	230 / 180	✿	50 - 60**	
<b>Pork</b>						
Fillet of pork, whole	Glass dish/ grill tray	2 (3)	230 / 180	✿	20 - 25**	Recipe tip: Marinate in a mixture of oil, garlic and parsley.
Pork medallions	Glass dish/ grill tray	2 (3)	180	✿	12 - 15*	Recipe tip: Just before you take them out of the oven, add a knob of butter and a sprig of rosemary to the glass dish/ grill tray and cook it all together for a little longer in the oven.
Joint of pork – leg (1 kg)	Glass dish/ grill tray	2 (3)	230 / 180	✿ / ✿ <sup>e</sup>	45 - 50**	
Joint of pork – neck (1.5 kg)	Glass dish/ grill tray	2 (3)	230 / 180	✿ / ✿ <sup>e</sup>	85 - 95**	
		2 (3)	230 / 180	☼	70 - 80**	
Joint of pork with crispy skin/roast pork with crackling (1.5 kg)	Wire rack + grill tray	2 (3)	180 / 200	☼	60 - 70***	
Pork knuckle	Wire rack + grill tray	2 (3)	150 / 200	☼	40 - 45***	Score the skin diagonally in both directions so that it is cross-hatched. This makes it nice and crispy.
Smoked pork (1 kg)	Glass dish/ grill tray	2 (3)	180 / 160	✿ / ✿ <sup>e</sup>	50 - 60**	

\* First, sear on all sides in a frying pan/roasting dish on the hob.

\*\* Sear the meat at a high temperature; after 15 - 20 minutes, set the lower temperature.

\*\*\* Cook the meat at a low temperature; set it to cook at the higher temperature for the last 15 - 20 minutes.



Dish	Accessories	Level	Temperature in °C	Heating function	Cooking time in min.	Comments
Rolled roasting joint	Glass dish/ grill tray	2 (3)	230 / 180	✦ / ✦ <sup>e</sup>	65 - 70***	
	Wire rack + grill tray	2 (3)	230 / 180	☼	75 - 80***	
<b>Veal</b>						
Joint of veal (1.5 kg)	Glass dish/ grill tray, roasting dish	2 (3)	180	✦ / ✦ <sup>e</sup>	50 - 60*	
Veal knuckle	Glass dish/ grill tray, roasting dish	2 (3)	150 / 180	☼	50 - 60***	
Veal loin	Glass dish/ grill tray, roasting dish	2 (3)	160 - 170	✦	20	
Stuffed breast of veal	Glass dish/ grill tray, roasting dish	2 (3)	120 - 130	✦ / ✦ <sup>e</sup>	120	
<b>Game</b>						
Wild boar joint	Glass dish/ grill tray, roasting dish	2 (3)	170	✦ / ✦ <sup>e</sup>	60 - 90*	Recipe tip: Marinate overnight in a mixture of oil, garlic, mustard and herbes de Provence.
Leg of roe venison	Glass dish/ grill tray, roasting dish	2 (3)	170 - 180	✦	60 - 80	
Saddle of venison	Glass dish/ grill tray, roasting dish	2 (3)	165 - 175	✦	20	
		2 (3)	165 - 175	---	20 - 25	
Saddle of rabbit	Glass dish/ grill tray, roasting dish	2 (3)	180	✦	15 - 25*	Recipe tip: Marinate in a mixture of garlic, rosemary, olive oil and high-quality balsamic vinegar.
Leg of lamb – medium rare	Glass dish/ grill tray, roasting dish	2 (3)	180 - 190	✦	100*	Recipe tip: Marinate overnight in a mixture of olive oil, garlic, rosemary and sliced lemon.
		2 (3)	180 - 190	✦	120*	
Lamb knuckle	Glass dish/ grill tray, roasting dish	2 (3)	180 - 200	✦	35 - 45	
<b>Miscellaneous</b>						
Meatballs (80 g per ball)	Baking tray + grease- proof paper	2 (3)	200	✦ / ✦ <sup>e</sup>	30 - 35	The flatter the meatballs, the faster they cook. Easy to make in large quantities.
Meatballs, lightly fried (80 g per ball)	Baking tray + grease- proof paper	2 (3)	200	✦ / ✦ <sup>e</sup>	20	Nicely browned yet juicy meatballs: First, fry them lightly in the frying pan, then put them in the oven.

\* First, sear on all sides in a frying pan/roasting dish on the hob.

\*\* Sear the meat at a high temperature; after 15 - 20 minutes, set the lower temperature.

\*\*\* Cook the meat at a low temperature; set it to cook at the higher temperature for the last 15 - 20 minutes.

Dish	Accessories	Level	Temperature in °C	Heating function	Cooking time in min.	Comments
Meatballs (25 g per ball)	Baking tray + grease-proof paper	2 (3)	200	✿ / ✿ <sup>e</sup>	25 - 30	Recipe tip: Easy to make into a meal, e.g. meatballs with tomato sauce, Swedish meatballs and Königsberger Klopse (Prussian meatballs in a white sauce with capers).
Meatballs, lightly fried (25 g per ball)	Baking tray + grease-proof paper	2 (3)	200	✿ / ✿ <sup>e</sup>	15	Recipe tip: Place meatballs made from minced lamb or rabbit on skewers and serve with mint yoghurt or fig mustard.
Meat loaf, fresh (700 g)	Wire rack + grill tray	2 (3)	160	✿ / ✿ <sup>e</sup>	60	Use a core temperature probe (core temperature 67 °C).
Rashers of bacon (oven-cooked bacon), thin	Baking tray + grease-proof paper	3 (4)	180	✿	8 - 10	Once you have taken the bacon out of the oven, place it on some kitchen towel to soak up the fat.
Rashers of bacon (oven-cooked bacon), thick	Baking tray + grease-proof paper	3 (4)	190	✿	8 - 12	
Stuffed peppers with minced meat	Ovenproof dish/roasting dish	2 (3)	175	✿ / ✿ <sup>e</sup>	55 - 60	Recipe tip: Stuff with minced meat and cook in tomato sauce.

\* First, sear on all sides in a frying pan/roasting dish on the hob.

\*\* Sear the meat at a high temperature; after 15 - 20 minutes, set the lower temperature.

\*\*\* Cook the meat at a low temperature; set it to cook at the higher temperature for the last 15 - 20 minutes.

## Poultry

- Use the core temperature probe so that you can monitor the core temperature more easily. Insert this between the belly and the thigh, rather than in the middle (cavity) of the bird. Further information and instructions, as well as optimal target temperatures, can be found in the section Core temperature probe.
- Poultry will turn out particularly crispy and brown if you baste it towards the end of the roasting time with butter, salted water, drained fat or orange juice.
- When cooking duck or goose, pierce the skin underneath the wings to allow the fat to run out.
- Use a roasting dish or another heat-resistant baking dish or tin for dishes that involve adding a lot of liquid to the roast. The same applies if a lot of fat is likely to drain from the food, e.g. for roast goose.

Meal	Accessories	Level	Temperature in °C	Type of heating	Cooking time in min.	Comments
Duck, whole (1.5-2 kg)	Wire rack + Grill tray/roasting dish	2 (3)	160/180	---	75*	Recipe tip: Stuff with oranges, apples or dried fruit.
Duck breast	Roasting dish/oven-proof dish	2 (3)	160	✿	25-35	Score the skin diagonally in both directions so that it is cross-hatched.
Goose, whole (5 kg)	Wire rack + Grill tray/roasting dish	2 (3)	160/190	✿/✿ <sup>e</sup>	110-130*	Recipe tip: Stuff with apples, onions and marjoram, and pin the opening closed with a cocktail stick or similar sharp item.
		2 (3)	160/190	---	110-130*	
Turkey, whole	Wire rack + Grill tray/roasting dish	2 (3)	160/190	✿/✿ <sup>e</sup>	120-180*	
		2 (3)	160/190	---	120-180*	

\* Cook the meat at a low temperature; set it to cook at the higher temperature for the last 15-20 minutes.

\*\* Turn food after half the cooking time has elapsed.

Meal	Accessories	Level	Temperature in °C	Type of heating	Cooking time in min.	Comments
Chicken, whole (1 kg)	Wire rack + Grill tray	2 (3)	180	✦	45-60	Baste with oil, salt, pepper, paprika and curry powder. Preheating.
		2 (3)	180	☞	45-50	
Chicken drumstick	Wire rack + Grill tray	3 (4)	220	☞	30**	Recipe tip: Asian marinade with soy sauce, honey, chilli, garlic, ginger, cumin, sweet lime zest and coriander.
		3 (4)	220	☞	30**	
Chicken leg	Wire rack + Grill tray	3 (4)	220	☞	30**	After the leg is turned, the side with more skin should be at the top. This makes it nice and crispy.  Marinate in a mixture of oil, rosemary, sliced lemon and garlic
		3 (4)	220	☞	30**	
Chicken breast	Wire rack + Grill tray	2 (3)	200	✦	20-25	Recipe tip: Rub with tandoori paste before cooking.
Chicken nuggets, frozen	Baking tray + Grease-proof paper	2 (3)	200	✦/✦ <sup>e</sup>	15**	
Quail breast	Baking tray	3 (4)	220	☞	10-12	Baste with oil and seasoning/spices, e.g. paprika, thyme, juniper and garlic.
Quail, whole (150 g per bird)	Wire rack + Grill tray	3 (4)	200	☞	20-25	Baste with oil and seasoning/spices, e.g. paprika, thyme, juniper and garlic.

\* Cook the meat at a low temperature; set it to cook at the higher temperature for the last 15-20 minutes.

\*\* Turn food after half the cooking time has elapsed.













## Grilling and roasting/baking

- Do not grill food with the oven door open.
- For grilling, use the grill tray with the wire insert (depending on the model, this may be an accessory or an optional accessory). Pour approximately 100 ml water into the grill tray; this will catch the meat juices so that the oven stays clean. If you pour in too much water, this may alter the cooking result because too much steam will be produced.
- The pieces of food to be grilled should be of roughly the same thickness (at least 2 to 3 cm). This will allow them to brown evenly and remain succulent and juicy. Never add salt to steaks before grilling them. Place the food to be grilled directly on the wire rack.
- If you use wooden skewers, they may char. To prevent this, shorten them as far as possible, leave them to soak in water overnight before skewering the ingredients or use metal skewers.
- For small quantities, use the energy-saving "Compact grill" heating function. With this heating function, only the centre part of the grill is heated.

Meal	Accessories	Level	Temperature in °C	Type of heating	Cooking time in min.	Comments
Pork belly, sliced	Wire rack + Grill tray	2 (3)	230	☞	18-20*	
		2 (3)	230	☞	18-20*	
Shish kebab	Wire rack + Grill tray	3 (4)	190	☞	16*	
Bratwurst (German sausage)	Wire rack + Grill tray	3 (4)	270	☞	10*	

\* Turn food after half the cooking time has elapsed.

\*\* Brown to the level you require.

Meal	Accessories	Level	Temperature in °C	Type of heating	Cooking time in min.	Comments
Merguez sausage	Wire rack + Grill tray	3 (4)	250		12*	
Spare ribs, pre-cooked	Wire rack + Grill tray	3 (4)	200-220		24*	
		3 (4)	200-220		24*	
Spare ribs, raw	Wire rack + Grill tray	3 (4)	220		40*	Recipe tip: Place in a mixture of oil, mustard, balsamic vinegar, honey, garlic, Worcester sauce, tomato purée and tabasco sauce.
		3 (4)	220		30*	
Saté chicken	Wire rack + Grill tray	3 (4)	250		10-14*	Serve with saté sauce.
Halloumi cheese (grilled cheese)	Wire rack + Grill tray	3 (4)	250		5-8	Halloumi is a semi-hard cheese used in Turkish and Greek cooking. It is excellent grilled.
Toasting bread	Wire rack	3 (4)	200		1-2*	Preheat for maximum five minutes. Stay by the appliance so that the toast does not brown too much.
Hawaii toast	Baking tray + grease-proof paper	3 (4)	190		8-10**	
Croque monsieur	Baking tray + grease-proof paper	3 (4)	190		8-11**	
Croutons	Baking tray	2 (3)	180		15*	Recipe tip: Mix fresh white bread with olive oil, garlic and rosemary leaves. Avoid using too much oil and wait until you are ready to serve before pouring it on; otherwise, the bread cubes will become saturated. Turn several times.
Browning meringue	Springform cake tin	2 (3)	220-250		4-5**	Stay by the appliance so that the meringue does not brown too much.
Prunes in a bacon blanket	Baking tray + grease-proof paper	3 (4)	200		8-10	Equally delicious with dates or apricots.

\* Turn food after half the cooking time has elapsed.

\*\* Brown to the level you require.

## Baking

- We recommend using dark-coloured metal baking tins as these absorb heat more effectively. Place the baking tin in the centre of the wire rack.
- If you are baking tray bakes without greaseproof paper, lightly grease the baking tray beforehand.
- Small baked items, e.g. cream puffs, biscuits and puff pastry parcels, can be baked on two levels, 1+3 or 2+4.
- If you are baking on more than one level, it is normal for food on baking trays placed in the oven at the same time to be ready at different times. Leave the food on the baking trays lower down in the oven to cook for a little longer, or place them in the appliance earlier next time.
- Before cutting the baked items, leave them to cool on a wire rack.
- If the baked items are too dark on the bottom, place them a level up and select a lower temperature. If the baked items are too dark on the top, place them a level down, select a lower temperature and extend the baking time a little.
- If the cake is too dry, set the temperature a little higher. If the cake remains uncooked in the middle, set a lower temperature. Baking times cannot be reduced by setting a higher temperature; it is better to set the temperature a little lower.
- If the cake collapses, use less liquid or set the temperature 10 °C lower. Do not open the oven door too soon.
- If the cake only rises in the middle, grease the sides of the baking tin.
- Do not remove the biscuits from the baking tray; place the baking tray back into the hot oven for a short period and remove the biscuits whilst they are still hot.
- If the cake does not come away from the tin when you are trying to turn it out, carefully slide a knife around the sides to loosen it. Turn the cake tin upside down again and cover it several times with a cold, wet cloth. Next time, grease the tin well and sprinkle some bread crumbs into it.
- In addition, always follow the manufacturer's instructions for pre-baked and frozen products.

Meal	Accessories	Level	Temperature in °C	Type of heating	Cooking time in min.	Comments
<b>Cake</b>						
Cheesecake	Springform cake tin	1 (2)	160-165	✿	70-75	
		1 (2)	160-165	---	70-75	
		1 (2)	160-165	✿	85-90	
		1 (2)	160-165	---	80-90	
		1 (2)	160-165	✿	40-45	Low-cheese cheesecake with 50% quark mixture.
Sponge cake	Springform cake tin	2 (3)	160-170	✿/✿ <sup>e</sup>	50-60	
		2 (3)	160-170	---	50-60	
Loaf cake	Cake tin	2 (3)	160-170	✿/✿ <sup>e</sup>	60-65	To ensure even browning, place the tin lengthways in the cooking compartment.
		2 (3)	160-170	---	55-60	
Bundt cake, Ring cake	Bundt pan	1 (2)	165-170	✿/✿ <sup>e</sup>	40-50	Recipe tip: Traditional ring cake or with bacon and walnuts.
		1 (2)	165-170	---	40-50	
		1 (2)	160-165	---	45-50	
Tray bakes	Baking tray	2 (3)	165-170	✿/✿ <sup>e</sup>	40-45	Lightly grease the baking tray.
		2 (3)	165-170	---	40-50	
Swiss roll	Baking tray + Grease-proof paper	2 (3)	190	✿	6	Whilst still hot, turn out onto a piece of greaseproof paper sprinkled with sugar, then roll up.

\* Preheat the appliance to the specified temperature. Turn the temperature down to the second specified temperature when placing the food in the oven.

\*\* Deactivate the "Rapid heating" function in the basic settings (see section *Basic settings*: Basic settings > Preheating speed/signal > Heating with signal)

Meal	Accessories	Level	Temperature in °C	Type of heating	Cooking time in min.	Comments
Sponge base	Springform cake tin	2 (3)	165-175	✿	30-35	Line a springform cake tin with greaseproof paper.
Yeast tray bakes	Baking tray	2 (3)	165	✿	30-35	Recipe tip: Top with plums, figs or onion and ham.
		2 (3)	165	---	30-35	
Fruit flan with shortcrust pastry	Tart tin or dish	2 (3)	165	✿/✿ <sup>e</sup>	40-50	Recipe tip: Top with strawberries or apricots and marzipan.
		2 (3)	170	---	40-50	
		2 (3)	165	✿	45-55	
Tart	Tart tin or dish	2 (3)	190	✿/✿ <sup>e</sup>	30-40	French flan with a shortcrust pastry base, e.g. tarte aux pommes, tarte tatin, tarte au chocolat and tarte au citron.
		2 (3)	190	---	30-40	
		2 (3)	190	✿	40-45	
		2 (3)	190	---	45-50	For light-coloured tart tins or dishes.
Strudel made from puff pastry	Baking tray + grease-proof paper	2 (3)	200	✿/✿ <sup>e</sup>	20-25	Recipe tip: Fill with custard and cherries or apples.
Apple pie (in accordance with EN 60350-1)	Springform cake tin, diameter 20 cm	2 (3)	160**	✿	85-105	Preheat
	Springform cake tin, diameter 20 cm	1 (2)	180**	---	80-95	Preheat
Water sponge torte (in accordance with EN 60350-1)	Springform cake tin, diameter 26 cm	2 (3)	160**	✿	22-30	Preheat
	Springform cake tin, diameter 26 cm	2 (3)	160**	---	20-45	Preheat
<b>Small baked items</b>						
Cream puffs, eclairs	Baking tray + grease-proof paper	2 (3)	180	✿/✿ <sup>e</sup>	35	Recipe tip: Fill with vanilla custard, chocolate mousse or fruit or mocha cream.
		2 (3)	180	---	40	
		2 (3)	180	✿	35	
Biscuits, Viennese whirls	Baking tray	2 (3)	160-170	✿/✿ <sup>e</sup>	15	
		2 (3)	160-170	---	18	
Small baked puff-pastry items	Baking tray + Grease-proof paper	2 (3)	200	✿/✿ <sup>e</sup>	15-20	
Puff pastry parcels, filled	Baking tray + Grease-proof paper	3 (4)	200	✿/✿ <sup>e</sup>	15	Recipe tip: Fill with ham and cheese or apples and raisins.

\* Preheat the appliance to the specified temperature. Turn the temperature down to the second specified temperature when placing the food in the oven.

\*\* Deactivate the "Rapid heating" function in the basic settings (see section *Basic settings*: Basic settings > Preheating speed/signal > Heating with signal)

Meal	Accessories	Level	Temperature in °C	Type of heating	Cooking time in min.	Comments
Puff pastry	Baking tray + Grease-proof paper	3 (4)	200	✚/✚ <sup>e</sup>	15	Recipe tip: With sesame seeds, poppy seeds, icing.
Puff pastry sticks	Baking tray + Grease-proof paper	3 (4)	200	✚/✚ <sup>e</sup>	15	Recipe tip: With cheese, ham, nuts.
Small pastries	Baking tray + Grease-proof paper	2 (3)	200	✚/✚ <sup>e</sup>	15-20	Recipe tip: With custard, fruit.
Waffle biscuits	Baking tray + Grease-proof paper	2 (3)	140	✚	8-10	Shape the waffle biscuits whilst they are still hot, e.g. into ice cream cones or small rolls for dessert.
Breadsticks	Baking tray + Grease-proof paper	2 (3)	160	✚	30	Sprinkle with sea salt, rosemary, curry powder, sesame seeds or caraway seeds.
Cookies (20 g per cookie)	Baking tray + Grease-proof paper	2 (3)	175	✚	12-14	With chocolate, raisins, nuts or lemon.
Brownies	Baking tray + Grease-proof paper	2 (3)	120	✚/✚ <sup>e</sup>	60-65	After baking, cut into squares. Typically, brownies retain a slightly sticky consistency in the middle.
Muffins	Muffin tray/ Paper baking cases	2 (3)	160	✚/✚ <sup>e</sup>	25-30	With chocolate, nuts or raisins.
		2 (3)	175	---	25-30	
		2 (3)	160-165	---	25-30	
Small cakes (in accordance with EN 60350-1)	Glass dish	2 (3)	150**	✚ <sup>e</sup>	25-40	Preheat
	Baking tray	3 (4)	150**	✚ <sup>e</sup>	25-40	Preheat
	Glass dish	1 (2)				Applies to baking on two levels
	Glass dish	3 (4)	160**	---	20-30	Preheat
Viennese whirls (in accordance with EN 60350-1)	Baking tray	2 (3)	140**	✚	30-40	Preheat
	Baking tray	3 (4)	140**	✚	30-45	Preheat
	Glass dish	1 (2)				Applies to baking on two levels
	Baking tray	2 (3)	160**	---	15-33	Preheat
<b>Bread, bread rolls</b>						
Multigr. bread	Baking tray + Grease-proof paper	2 (3)	200/170*	✚/✚ <sup>e</sup>	40-50	
		2 (3)	200/170*	---	40-50	
		2 (3)	200/165*	---	45-50	
Sourdough bread	Baking tray	2 (3)	200/180*	---	50-60	
Olive and tomato bread	Baking tray	2 (3)	200/170*	---	40-50	
Bread in a loaf tin	Cake tin	2 (3)	175	---	40-45	

\* Preheat the appliance to the specified temperature. Turn the temperature down to the second specified temperature when placing the food in the oven.

\*\* Deactivate the "Rapid heating" function in the basic settings (see section *Basic settings*: Basic settings > Preheating speed/signal > Heating with signal)

Meal	Accessories	Level	Temperature in °C	Type of heating	Cooking time in min.	Comments
Baguette, pre-baked	Baking tray + Grease-proof paper	2 (3)	220	---	10-12	
Ciabatta, pre-baked	Baking tray + Grease-proof paper	2 (3)	190	---	12-14	
		2 (3)	180	✿/✿ <sup>e</sup>	12-14	
Flatbread	Baking tray + Grease-proof paper	2 (3)	200	✿/✿ <sup>e</sup>	15-20	The cooking time depends on the size and thickness of the flatbread.
		2 (3)	210	---	15-20	
Foccacia	Baking tray + Grease-proof paper	2 (3)	210	---	15-20	Top with various ingredients, e.g. herbs, sea salt, olives, anchovies, onion, ham, tomatoes or cheese.
Garlic/herb baguette	Baking tray + Grease-proof paper	2 (3)	200	---	8-10	
Strudel made from puff pastry	Baking tray + Grease-proof paper	2 (3)	200	✿/✿ <sup>e</sup>	20-25	Recipe tip: Fill with sheep's cheese and feta cheese.
Plaited loaf	Baking tray + Grease-proof paper	2 (3)	165	✿/✿ <sup>e</sup>	30	
		2 (3)	160-165	--	30-35	
Bread rolls, pre-baked	Baking tray + Grease-proof paper	2 (3)	210	---	8-10	
		2 (3)	200	✿/✿ <sup>e</sup>	8-10	
Bread rolls, frozen	Baking tray + Grease-proof paper	2 (3)	180	✿/✿ <sup>e</sup>	10-12	
		2 (3)	200	---	10-12	
Bread rolls, fresh (50 g per roll)	Baking tray + Grease-proof paper	2 (3)	250/200*	---	15-20	
Baked items made from lye-dipped yeast dough, frozen	Baking tray + Grease-proof paper	2 (3)	200	✿/✿ <sup>e</sup>	10-12	
Croissants, frozen	Baking tray + Grease-proof paper	2 (3)	170	---	15-25	

\* Preheat the appliance to the specified temperature. Turn the temperature down to the second specified temperature when placing the food in the oven.

\*\* Deactivate the "Rapid heating" function in the basic settings  
(see section *Basic settings*: Basic settings > Preheating speed/signal > Heating with signal)

















## Raising dough

- Place the bowl containing the dough onto the wire rack. Select the "Dough proving" heating function.
- For large quantities, e.g. bread, set the temperature to 38 - 40 °C. This helps the dough to rise evenly from the centre to the edges.
- For small quantities of dough, e.g. sweet pastry swirls and bread rolls, you can set a temperature of 40 - 45 °C.
- The cooking time specified is intended as a guide only. Leave the dough to rise until it has doubled its volume.
- If the dough does not rise, this means that either you have not used sufficient yeast or you have not kneaded the dough sufficiently.

Dish	Accessories	Level	Temperature in °C	Heating function	Cooking time in min.	Comments
Dough mixture	Bowl	2 (3)	38		25 - 45	e.g. yeast dough, natural fermentation starter, sourdough, yeast dumplings

## Desserts

- Oven-cooked desserts are very easy to prepare – all that remains is to put them in the oven. This preparation method is useful for relatively large quantities, for example if you have guests.
- Oven-cooked desserts are generally eaten hot, and are very enjoyable particularly during the colder months.

Dish	Accessories	Level	Temperature in °C	Heating function	Cooking time in min.	Comments
Apple crumble	Ovenproof dish	2 (3)	200	 / 	35 - 40	Apple bake with a crumble topping; equally delicious with berries or mirabelles.
		2 (3)	200		25 - 30	For soft apple varieties.
		2 (3)	200		25 - 30	For firm apple varieties.
Baked apple	Ovenproof dish	2 (3)	190 - 200	 / 	20 - 30	Recommendation: Use cooking apples, e.g. Boskop. These are particularly well suited for cooking and baking. Summer version: Stuff with ricotta cheese, lemon, honey, cardamom, vanilla and pine nuts.
Compote	Glass dish/ grill tray	2 (3)	160 - 180	 / 	30 - 40	e.g. apricots or a variety of berries
		2 (3)	200		30 - 40	Do not add any liquid; stir thoroughly several times. Refine with honey, fresh vanilla or cinnamon.
Clafoutis	Ovenproof dish	2 (3)	190 - 200		30 - 35	French dessert: Traditionally made with cherries; equally delicious with mirabelles or berries.
Sweet bake	Ovenproof dish	2 (3)	160 - 180	 / 	30 - 40	e.g. semolina, quark or rice pudding
Bread and butter pudding, Kirschenmichel (German bread and butter pudding with sour cherries)	Ovenproof dish	2 (3)	150	 / 	50 - 55	e.g. with cherries or apricots

Dish	Accessories	Level	Temperature in °C	Heating function	Cooking time in min.	Comments
Topfenpalatschinken (baked sweet pancakes with a quark filling)	Ovenproof dish	2 (3)	180 - 190	✿ / ✿ <sup>e</sup>	8 - 10	Austrian speciality: Pancakes filled with quark and raisins, topped with cream and grilled.
Meringue	Baking tray + grease-proof paper	2 (3)	100	✿	150	When dividing up the mixture, make sure that the portions are spread as thinly as possible so that the mixture dries out well.

## Defrosting

- To defrost food, use the "Defrost" heating function.
- The defrosting times specified are intended as a guide only. The defrosting time depends on the size, weight and shape of the frozen food. This reduces the defrosting time.
- Slide the wire rack with the frozen food into the second rack level (into the third rack level if there are five rack levels). Slide the glass dish/grill tray underneath to catch any liquid that drips down as the food defrosts.
- Remove the food from the packaging before defrosting.
- Do not defrost more food than you intend to eat on this occasion.
- Remember: Once defrosted, food may not keep for as long and spoils faster than fresh food. Prepare defrosted food immediately and cook it thoroughly.

- After half the defrosting time has elapsed, turn the meat or fish. Break up frozen clumps of food comprising many pieces, e.g. berries and pieces of meat. Fish does not need to be fully defrosted; it is sufficient to defrost it until the surface is soft enough for seasoning/spices to stick.
- The oven is not suitable for defrosting whole chickens or joints of meat as this takes a very long time. Steam ovens and combination steam ovens can be used to defrost this kind of food much more quickly.

### Health risk!

When defrosting food from animal sources, you must remove the liquid that escapes during defrosting. It must never come into contact with other food. Germs could be transferred.

Slide the glass dish/grill tray under the food and into the appliance. Pour away the liquid that collects in the dish or tray as the meat and poultry defrosts. Then clean the sink and rinse with plenty of water. Clean the glass dish/grill tray in hot soapy water or in the dishwasher. After defrosting, operate the oven for 15 minutes at 180 °C in the "Hot air" (fan-oven) setting.

Dish	Accessories	Level	Temperature in °C	Heating function	Cooking time in min.	Comments
Berries (500 g)	Glass dish/ grill tray	2 (3)	50 - 55	* ◊	25 - 30	
Vegetables (500 g)	Glass dish/ grill tray	2 (3)	50 - 55	* ◊	30 - 50	The defrosting time depends on the portions. Small vegetables, such as peas and beans, defrost more quickly than frozen spinach blocks and cauliflower florets.
Chicken thighs (200 g per thigh)	Wire rack	2 (3)	50 - 55	* ◊	45 - 50*	
Fish fillet (150 g per fillet)	Wire rack	2 (3)	45 - 50	* ◊	45 - 50*	
Prawns	Wire rack	2 (3)	45 - 50	* ◊	20 - 25	

\* Add an equalisation period: Once the defrosting time has elapsed, switch off the appliance and leave the food to rest in the appliance for a further 10 - 15 minutes with the door closed so that it has a chance to defrost right through to the very centre.

## Preserving

- Cook food as soon as possible after purchase or after it has been harvested/picked/dug up. Prolonged storage reduces the vitamin content and means that food is on the verge of fermenting.
- Only use fruit and vegetables that are in good condition.
- The oven is not suitable for preserving meat.
- Carefully check and clean the preserving jars, rubber sealing rings, clips and springs.
- Place the preserving jars in a heat-resistant vessel containing water. Make sure that they do not touch. The water level must reach at least three quarters of the way up to the top of the contents of the jars.
- Once the cooking time has elapsed, open the oven door. Do not remove the preserving jars from the cooking compartment until they have completely cooled down.
- Store the preserves in a cool, dark and dry place, e.g. in a pantry. Once the jars have been opened, consume the contents quickly and store in the refrigerator.

Dish	Accessories	Level	Temperature in °C	Heating function	Cooking time in min.	Comments
Fruit	Wire rack	1 (2)	150 - 160	---	35 - 40	In sealed jars
Vegetables	Wire rack	1 (2)	190 - 200	---	60 - 120	In sealed jars

## Disinfecting

- Before you begin preserving the food, the glasses should be disinfected in the oven to prevent the food from spoiling. This is the only way to ensure that preserves keep for a relatively long time and can be stored outside of the refrigerator.
- Disinfect the empty jars at 100 °C for at least 20 minutes in the "Hot air" (fan-oven) setting. The lids and rubber preserving seals for the jars can be disinfected at the same time in boiling water to avoid them drying out in the dry heat of the oven.

Dish	Accessories	Level	Temperature in °C	Heating function	Cooking time in min.	Comments
Disinfecting	Wire rack	2 (3)	100	✿ / ✿ <sup>e</sup>	20 - 25	Preserving jars, baby bottles

## Drying

- Drying is a method of preserving food in which up to 50% of the liquid contained in the food is removed by exposing it to dry heat. This also makes the flavour more intense.
- The thicker the food, the longer the drying process lasts. The quickest way to dry food – which is also the method that saves the most energy – is to cut it into slices.
- Place the prepared food onto a wire rack or baking tray covered with greaseproof paper. Turn the food from time to time during the drying process.
- The duration depends on the thickness of the food and on the natural level of moisture in the food, i.e. tomatoes take longer to dry out than mushrooms.
- If you want to dry food in the oven on two levels at the same time, use levels 1 and 3 (or 2 and 4).

Dish	Accessories	Level	Temperature in °C	Heating function	Cooking time in hours	Comments
Sliced mushrooms	Wire rack + greaseproof paper	2 (3)	50 - 60	✿ / ✿ <sup>e</sup>	3 - 4	
Apple rings	Wire rack + greaseproof paper	2 (3)	50 - 70	✿ / ✿ <sup>e</sup>	5 - 8	
Quartered tomatoes	Wire rack + greaseproof paper	2 (3)	60 - 70	✿ / ✿ <sup>e</sup>	7 - 8	Core the tomatoes to avoid an extended drying time.
Herbs	Wire rack + greaseproof paper	2 (3)	50 - 60	✿ / ✿ <sup>e</sup>	1½ - 2	e.g. chives, parsley and sage

## Baking stone

- You will need a baking stone and heating element – these are optional accessories.
- Whether you are baking crispy pizza or fresh bread, with the baking stone, you will achieve results that are comparable to, or even exceed, those that you would get from a massive stone oven because you are able to precisely control the baking temperature.
- Depending on the size, you can place several pizzas, bread rolls or other baked items on the baking stone at once.
- You can bake several pizzas in succession. This may increase the baking time per pizza by approx. 1 - 3 minutes.
- We recommend that you use a core temperature probe when baking bread. Insert the core temperature probe at the thickest point in the pizza base. The probe measures the temperature within the baked items and switches the oven off once the set core temperature has been reached.
- When dough is baked, it needs to be able to expand without the surface breaking apart. This can be achieved by pricking it several times with a fork or by making a cut with a knife.
- The temperatures and times specified in the cooking table are average values. In addition, always follow the manufacturer's instructions for pre-cooked and frozen products.

Dish	Accessories	Level	Temperature in °C	Heating function	Cooking time in min.	Comments
Bread rolls, fresh (50 g per roll)	Baking stone	1	250 / 200*	☰	15 - 20	
Flatbread	Baking stone	1	210	☰	15	The cooking time depends on the size and thickness of the flatbread
Foccacia	Baking stone	1	210	☰	15	Top with various ingredients, e.g. herbs, sea salt, olives, anchovies, onion, ham, tomatoes or cheese.
Multigrain bread	Baking stone	1	175	☰	45	

\* Preheat the appliance to the specified temperature. Turn the temperature down when placing the food in the oven.

Dish	Accessories	Level	Temperature in °C	Heating function	Cooking time in min.	Comments
Sourdough bread	Baking stone	1	250 / 200*		50 - 60	
Olive and tomato bread	Baking stone	1	175		45	
Pizza, fresh	Baking stone	1	275		5 - 8	The cooking time varies depending on the type and thickness of the dough and topping.
Pizza, frozen	Baking stone	1	230		8 - 10	The cooking time varies depending on the thickness of the dough. Follow the manufacturer's instructions.
Savoury flan, fresh	Baking stone	1	300		3 - 4	Recipe tip: Traditional or with goats' cheese, Parma ham, figs and spring onion.
Savoury flan, frozen	Baking stone	1	250		4 - 5	

\* Preheat the appliance to the specified temperature. Turn the temperature down when placing the food in the oven.

## Roasting dish

- You will need a roasting dish and heating element – these are optional accessories.
- You can also easily prepare large pieces of meat in the roasting dish, and you can braise large quantities of meat.
- Food is easy to prepare and can be kept warm in the oven. Your kitchen looks tidy, the hob is not dirty, and fewer cooking smells are produced as the dish is being cooked in the oven.
- The non-stick coating enables you to roast using very little fat.  
Tip: Rather than adding the fat to the roasting dish, brush oil over the meat. This ensures that the heat is transferred directly to the meat.
- Cooking liquids reduce down quickly. Make sure that there is always sufficient cooking liquid. For a cooking time of 30 minutes, add approx. ½ l of liquid.
- When cooking in a sauce, always ensure that the sauce remains runny and add cooking liquid.
- In addition, follow the instructions in the instruction manual for the roasting dish.

Dish	Accessories	Level	Temperature in °C	Heating function	Cooking time in min.	Comments
Chicken breast	Roasting dish	1	200		Initial roasting + 15 - 20	Before you place the food in the roasting dish, heat it up using the "Roasting function". Then insert the core temperature probe.
Beef goulash	Roasting dish	1	220 / 130 - 140*		Initial roasting + 60 - 120	Roast the onion and meat initially; use the "Roasting function" for this. Pour in liquid and turn the temperature back down; cook for 60 - 120 minutes depending on the type of meat
Ossobuco	Roasting dish	1	220 / 140*		Initial roasting + 60 - 90	Roast the meat and vegetables initially; use the "Roasting function" for this. Pour in liquid and turn the temperature back down; cover and cook for a further 60 - 90 minutes. Turn the sliced shanks once.

\* Roast initially at a high temperature; to continue cooking, turn the temperature back down.

Dish	Accessories	Level	Temperature in °C	Heating function	Cooking time in min.	Comments
Viennese boiled beef	Roasting dish	1	220 / 130*	<input type="checkbox"/>	Initial roasting + 210 - 240	Roast the onion halves for a short time, add the vegetables and roast briefly, then fill the dish with liquid. Bring the vegetable water to the boil, season and add the Viennese boiled beef. The meat should be completely covered in liquid. Place the lid on the roasting dish and continue cooking at a temperature of 130 °C.
Venison ragout	Roasting dish	1	220 / 130 - 140*	<input type="checkbox"/>	Initial roasting + 60 - 100	Roast the meat and other ingredients initially; use the "Roasting function" for this. Pour in liquid and turn the temperature back down; cook for 60 - 100 minutes depending on the type of meat and the size of the pieces of meat.
Roulades	Roasting dish	1	220 / 120*	<input type="checkbox"/>	Initial roasting + 60 - 90	Roast the roulades initially in portions; use the "Roasting function" for this.
Tortilla	Roasting dish	1	175	<input type="checkbox"/>	Initial roasting + 10 - 15	Roast all the ingredients initially in the roasting dish, apart from the eggs; then pour the egg mixture over the top and continue cooking until the tortilla is firm.
Farmers' omelette	Roasting dish	1	175	<input type="checkbox"/>	Initial roasting + 10 - 15	Roast all the ingredients initially in the roasting dish, apart from the eggs; then pour the egg mixture over the top and continue cooking until the farmers' omelette is firm.
Stuffed peppers, vegetarian	Roasting dish	1	200	<input type="checkbox"/>	30	Recipe tip: Stuff with boiled rice, soft wheat or lentils and onions, cheese, herbs and seasoning/spices.
Chilli con carne	Roasting dish	1	220 / 130*	<input type="checkbox"/>	Initial roasting + 60 - 90	

\* Roast initially at a high temperature; to continue cooking, turn the temperature back down.

## Acrylamide in foodstuffs

Which foods are affected?

Acrylamide is mainly produced in grain and potato products that are heated to high temperatures, such as crisps, chips, toast, bread rolls, bread, fine baked goods (biscuits, gingerbread, cookies).

---

### Tips for keeping acrylamide to a minimum when preparing food

---

General	Keep cooking times as short as possible. Cook food until it is golden brown, but not too dark. Large, thick pieces of food contain less acrylamide.
Baking	With hot air at max. 180 °C.
Biscuits	Egg or egg yolk reduces the production of acrylamide. Spread out a single layer evenly on the baking tray.
Oven Chips	Cook at least 400 g at once on a baking tray so that the chips do not dry out.

---

**Gaggenau Hausgeräte GmbH**  
Carl-Wery-Straße 34  
81739 München  
GERMANY  
[www.gaggenau.com](http://www.gaggenau.com)

**GAGGENAU**



9000914366 en (960301)