

Panasonic®

Operating Instructions and Cookbook

Steam Combination Oven

Model No. NN-DS596B



NN-DS596B

**FOR DOMESTIC USE ONLY
IMPORTANT SAFETY INSTRUCTIONS
PLEASE READ CAREFULLY AND KEEP FOR FUTURE REFERENCE**

Important notice

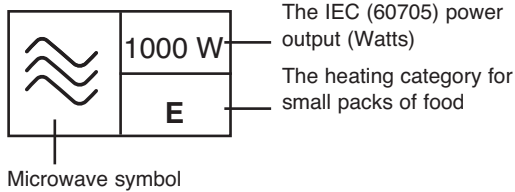

Thank you for purchasing a Panasonic Microwave Oven.

Your oven is rated 1000 Watts (IEC). When using other cookbooks remember to adjust cooking times accordingly. The symbol indicates the heating category for your oven when cooking or reheating convenience foods.

Your oven is rated 'E', which is very efficient. It is therefore very important that you refer carefully to the packet instructions on convenience foods.

Some packet instructions only display information for B or D rated ovens. We therefore provide additional guidelines for reheating and cooking on pages **61-75** of this book.

Always check the progress of the food as it cooks or reheats by simply opening the door. After checking the progress of the foods, touch Start to continue the cooking time.

Failure to follow the instructions given in this operating instructions and cookbook, may affect the recipe result and in some instances may be dangerous.



Customer Communications Centre 0344 344 3899

Selected Spares and Accessories:

Order direct on line at www.panasonic.co.uk or by telephoning the Customer Communications Centre number above.

For Cookery Advice call: 01344 862108 (open Monday to Wednesday 9 am - 12 pm)
Alternatively visit our website at www.theideaskitchen.co.uk

Thank you for purchasing this Panasonic appliance.

Contents

Safety instructions	2-6	Grilling	33-34
Disposal of waste products.....	7	Panacrunch	35
Important safety instructions.....	8-9	Oven cooking.....	36-38
Before using your oven.....	10	Steam cooking.....	39-40
Placement of your oven.....	10	Steam Shot	41
Care and cleaning of your oven.....	11	Combination cooking with steam.....	42-43
Maintenance of your oven	12	Combination Grill and microwave	44-45
Accessory advice.....	12	Multi-stage cooking.....	46-47
Oven accessory	13	Using the timer	48-49
Parts of your oven	14-15	Chaos defrost	50-51
Important information.....	15-17	Auto steam programs	52-53
Microwaving principles	18	Auto cook programs	54-55
Control panel	19	Panacrunch programs	56-57
General guidelines.....	20-21	System cleaning programs	58
Quick check guide to cooking utensils	22	Cleaning the water tank.....	59
Containers to use	22-23	Cooking and reheating guidelines	60
Cooking modes.....	24	Reheating charts	61-66
Combination cooking modes	25	Cooking charts.....	67-75
Let's start to use your oven	26	Steam only cooking chart	75
Setting the clock	27	Increasing and decreasing recipes.....	76
Child lock.....	27	Using recipes from other books.....	76
Operation guide setting	28	Cooking for one	76
Microwave cooking and defrosting	29	Recipes.....	77-104
Defrosting guidelines	30	Questions and answers.....	105-106
Defrosting chart	31-32	Specifications	107

Operating Instructions

Safety instructions

- Important safety instructions. Before operating this oven, please read these instructions carefully and keep for future reference.
- This appliance can be used by children aged from 8 years and above and persons with reduced physical, sensory and mental capabilities or lack of experience and knowledge if they have been given supervision or instruction by a person responsible for their safety concerning the use of the appliance in a safe way and understand the hazards involved, including escaping steam. Children shall not play with the appliance. Cleaning and user maintenance shall not be made by children without supervision. Keep the appliance and its cord out of reach of children less than 8 years.
- When this oven is installed, it should be easy to isolate the appliance from the electricity supply by pulling out the plug or operating a circuit breaker.
- If the supply cord is damaged, it must be replaced by the manufacturer or its service agent or a similarly qualified person in order to avoid a hazard.
- Warning! The appliance should be inspected for damage to the door seals and door seal areas and if these areas are damaged the appliance should not be operated until it has been repaired by a service technician trained by the manufacturer.
- Warning! Do not attempt to tamper with or make any adjustments or repairs to the door, control panel housing, safety interlock switches or any other part of the oven.
- Warning! Do not remove the outer panel from the oven which gives protection against exposure to microwave energy.

Safety instructions

- Repairs should only be made by a qualified service person.
- Warning! Liquids and other foods must not be heated in sealed containers since they are liable to explode.
- Warning! Only allow children to use the oven without supervision when adequate instructions have been given so that the child is able to use the oven in a safe way and understands the hazards of improper use.
- This oven is intended for Counter-top use only. It is not intended for built-in use or for use inside a cupboard.

For Counter-top use:

- The oven must be placed on a flat, stable surface 85 cm above the floor, with rear of oven placed against a back wall. For proper operation the oven must have sufficient air flow, i.e. 5 cm at one side, the other being open; 15 cm clear over the top; 10 cm at the rear.
- When heating food in plastic or paper containers, check the oven frequently as these types of containers ignite if overheated.
- If smoke is emitted or a fire occurs in the oven, touch Stop/Cancel and leave the door closed in order to stifle any flames. Disconnect the power cord, or shut off power at fuse or circuit breaker panel.
- This appliance is intended to be used in household applications only.
- When heating liquids, e.g. soup, sauces and beverages in your oven, overheating the liquid beyond boiling point can occur without evidence of bubbling. This could result in a sudden boil over of the hot liquid.

Safety instructions

- The contents of feeding bottles and baby food jars are to be stirred or shaken. The temperature has to be checked before consumption to avoid burns.
- Do not cook eggs in their shells and whole hard-boiled eggs by **microwave**. Pressure may build up and the eggs may explode, even after the microwave heating has ended.
- Clean the inside of the oven, door seals and door seal areas regularly. When food splatters or spilled liquids adhere to the oven walls, base of the oven, door seals and door seal areas wipe off with a damp cloth. Mild detergent may be used if they get very dirty. The use of harsh detergent or abrasive cleaners is not recommended.
- **Do not use commercial oven cleaners.**
- When using the **grill, oven, steam, Panacrunch** or **combination** modes, some foods may inevitably splatter grease on to the oven walls. If the oven is not cleaned occasionally, it may start to 'smoke' during use.
- Failure to maintain the oven in a clean condition could lead to deterioration of surfaces that could affect the life of the appliance and possibly result in a hazardous situation.
- Warning! The accessible parts may become hot in **grill, oven, steam, Panacrunch** and **combination** use. Young children less than 8 years of age should be kept away. Children should only use the oven under adult supervision due to the temperatures generated.
- A steam cleaner is not to be used for cleaning the appliance.

Safety instructions

- Do not use harsh, abrasive cleaners or sharp metal scrapers to clean the oven door glass since they can scratch the surface, which may result in shattering of the glass.
- Exterior oven surfaces, including air vents on the cabinet and the oven door will get hot during **grill, oven, steam, Panacrunch** and **combination** modes, take care when opening or closing the door and when inserting or removing food and the accessory.
- This appliance is not intended to be operated by means of an external timer or separate remote-control system.
- Only use utensils that are suitable for use in microwave ovens.
- Warning! This appliance produces boiling hot steam.
- During and after cooking with steam function, do not open the oven door when your face is very close to the oven. Care must be taken when opening the door as steam may cause injury.
- Warning! Steam may billow out when you open the door. If there is steam in the oven, do not reach in with your bare hands! Risk of burns! Use oven gloves.
- Please refer to pages 12-13 for correct installation of the shelf accessory.
- The oven has two grill heaters situated in the top of the oven and two heaters situated in the base of the oven. After using the **grill, oven, steam, Panacrunch** and **combination** functions, the inside surfaces of the oven will be very hot. Care should be taken to avoid touching the heating elements inside the oven. To prevent burns, care should be taken to avoid touching the inside surfaces of the oven.

Safety instructions

- This combination oven is intended for heating food and beverages only. Take care when heating foods low in moisture, e.g. bread items, chocolate, biscuits and pastries. These can easily burn, dry out or catch fire if cooked too long. We do not recommend heating foods low in moisture such as popcorn or poppadoms. Drying of food, newspapers or clothing and heating of warming pads, slippers, sponges, damp cloths, wheat bags, hot water bottles and similar may lead to risk of injury, ignition or fire.
- The oven lamp must be replaced by a service technician trained by the manufacturer. **Do not** attempt to remove the outer casing from the oven.
- Before using the oven, place the drip tray in position. Refer to page 14 for correct installation.
- The purpose of the drip tray is to collect excess water during **steam** and **microwave** mode. It should be emptied after each **steam** and **microwave** operation.
- Do not use the water tank if it is cracked or broken, as leaking water could result in electrical failure and danger of electric shock. If the water tank becomes damaged, please contact your dealer.
- **Caution!** In order to avoid a hazard due to inadvertent resetting of the thermal cut-out, this appliance must not be supplied through an external switching device, such as a timer, or connected to a circuit that is regularly switched on and off by the utility.

Disposal of waste products



Information on disposal for users of Waste Electrical & Electronic Equipment (private households)

This symbol on the products and/or accompanying documents means that used electrical and electronic products should not be mixed with general household waste.

For proper treatment, recovery and recycling, please take these products to designated collection points, where they will be accepted on a free of charge basis. Alternatively, in some countries you may be able to return your products to your local retailer upon the purchase of an equivalent new product.

Disposing of this product correctly will help to save valuable resources and prevent any potential negative effects on human health and the environment which could otherwise arise from inappropriate waste handling. Please contact your local authority for further details of your nearest designated collection point.

Penalties may be applicable for incorrect disposal of this waste, in accordance with national legislation.

For business users in the European Union

If you wish to discard electrical and electronic equipment, please contact your dealer or supplier for further information.

Information on disposal in other countries outside the European Union



This symbol is only valid in the European Union.

If you wish to discard this product, please contact your local authorities or dealer and ask for the correct method of disposal.

Important safety instructions

Read carefully and keep for future reference

This appliance is supplied with a moulded three pin mains plug for your safety and convenience. A 13 amp fuse is fitted in this plug. Should the fuse need to be replaced, please ensure that the replacement fuse has a rating of 13 amps and that it is approved by ASTA or BSI to BS1362.

Check for the ASTA mark  or the BSI mark  on the body of the fuse.

If the fuse cover is detachable, never use the plug with the cover omitted.

A replacement fuse cover can be purchased from your local Panasonic dealer.

■ How to replace the fuse

Open the fuse compartment with a screwdriver and replace the fuse.

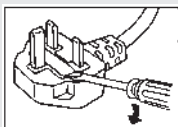

If the fitted moulded plug is unsuitable for the socket outlet in your home then the fuse should be removed and the plug cut off and disposed of safely and an appropriate one fitted. There is a danger of severe electrical shock if the cut off plug is inserted into any 13 amp socket.

If a new plug is to be fitted, please observe the wiring code as shown opposite. If in any doubt, please consult a qualified electrician (For U.K. models only).



Warning!

This appliance must be earthed.



Important

The wires in this mains lead are coloured in accordance with the following code:

Green-and-yellow: Earth,

Blue: Neutral

Brown: Live.

As the colours of the wire in the mains lead of this appliance may not correspond with the coloured markings identifying the terminals in your plug, proceed as follows:

The wire which is coloured **green-and-yellow** must be connected to the terminal in the plug which is marked with the letter E or by the Earth symbol  or coloured **green** or **green-and-yellow**.

The wire which is coloured **blue** must be connected to the terminal in the plug which is marked with the letter N or coloured **black**. The wire which is coloured **brown** must be connected to the terminal in the plug which is marked with the letter L or coloured **red**.

When this oven is installed it should be easy to isolate the appliance from the electricity supply by pulling out the plug or operating a circuit breaker.

■ Voltage & power

The voltage used must be the same as specified on this microwave oven. Using a higher voltage than that which is specified is dangerous and may result in a fire or other type of accident causing damage.

Do not immerse cord, plug or oven in water. Keep cord away from heated surfaces. Do not let cord hang over the edge of table or work top. Do not plug your oven in via an extension cable as this can be dangerous. It is important to plug the oven directly into a wall socket.

The back of the appliance heats up during use. Do not allow the cord to be in contact with the back of the appliance or cabinet surface.

Important safety instructions

1. In case of electronic failure, oven can only be turned off at wall socket.



Warning!

Only allow children to use the oven without supervision when adequate instructions have been given so that the child is able to use the oven in a safe way and understands the hazards of improper use. Ensure that children do not touch the hot outer casing after operation of the oven.

2. This appliance can be used by children aged from 8 years and above and persons with reduced physical, sensory and mental capabilities or lack of experience and knowledge if they have been given supervision or instruction by a person responsible for their safety concerning the use of the appliance in a safe way and understand the hazards involved.
3. Children shall not play with the appliance. Cleaning and user maintenance shall not be made by children without supervision.
4. During and after cooking with a steam function, do not open the oven door when your face is very close to the oven. Care must be taken when opening the door as steam may cause injury.
5. To prevent burns, take care of hot surfaces which may exist from the cooking process.



Caution!

Steam may billow out when you open the door. If there is steam in the oven, do not reach in with your bare hands! Risk of burns! Use oven gloves.

Storage of accessories

6. Do not store any objects other than oven accessory inside the oven in case it is accidentally turned on.

Exterior oven surfaces

7. Exterior oven surfaces, including air vents on the right side of the cabinet and the oven door will get hot during **grill, oven, steam, Panacrunch** and **combination** modes. Take care when opening or closing the door and when inserting or removing food and the accessory.

Heater

8. The oven has two grill heaters situated in the top of the oven and two heaters situated in the base of the oven. After using the **grill, oven, steam, Panacrunch** and **combination** functions, the inside surfaces of the oven will be very hot. Care should be taken to avoid touching the heating elements inside the oven.



Caution! Hot surfaces

After cooking by these modes, the Square Panacrunch Pan will be very hot.

9. Before using **grill, oven, steam** or **combination** function for the first time operate the oven without food and the accessory on **oven 220 °C** for **10 minutes**. This will allow the oil that is used for rust protection to be burned off. This is the only time that the oven is operated completely empty.



Caution!

Grill elements and oven will be hot. **Do not operate the oven empty** apart from point 9 above. The appliance must not be operated by **microwave** or combination including microwave **without food in the oven**. Operation when empty will damage the appliance.

The accessible parts may become hot in **grill, oven, steam, Panacrunch** and **combination** use. Young children less than 8 years of age should be kept away. Children should only use the oven under adult supervision due to the temperatures generated.

Before using your oven

Examine your oven

1. Unpack oven, remove all packing material, and examine the oven for any damage such as dents, broken door latches, cracks in the door or any damage to the water tank. Notify dealer immediately if unit is damaged. DO NOT install if unit is damaged.

Guarantee

2. Your receipt is your guarantee, please keep it safe.

Cord

3. If the supply cord of this appliance is damaged, it must be replaced by the manufacturer or its service agent or a similarly qualified person in order to avoid a hazard.

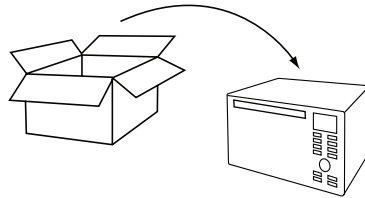

Note

The appliance should be inspected for damage to the door seals and door seal areas. If these areas are damaged the appliance should not be operated until it has been repaired by a service technician trained by the manufacturer.

Placement of your oven

This oven is intended for counter-top household use only. It is not intended for built-in use or for use inside a cupboard.

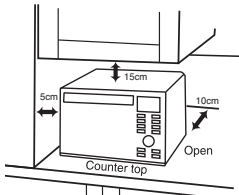

1. The oven must be placed on a flat, stable surface 850 mm above the floor, with rear of oven placed against a back wall. For proper operation the oven must have sufficient air flow, i.e. 5 cm at one side, the other being open; 15 cm clear over the top; 10 cm at the rear.
2. Do not place the microwave oven on a shelf directly above a gas or electric hob. This may be a safety hazard and the oven may be damaged.
3. Do not block air vents on the right side of the oven. If air vents are blocked during operation, the oven may overheat. If the oven overheats, a thermal safety device will turn the oven off. The oven will remain inoperable with blank display until it has cooled.
4. This appliance is intended to be used in household applications only.

Care and cleaning of your oven



Important

It is essential for the safe operation of the oven that it is kept clean, and wiped out after each use. Failure to maintain the oven in a clean condition could lead to deterioration of a surface that could adversely affect the life of the appliance and possibly result in a hazardous situation.

1. **Switch the oven off before cleaning** and unplug at the socket if possible.
2. **Keep the inside of the oven, door seals and door seal areas clean.** When food splatters or spilled liquids adhere to oven walls, door seals and door seal areas wipe off with a damp cloth. Mild detergent may be used if they get very dirty. The use of harsh detergent or abrasives is not recommended.
3. After using **grill, oven, steam, Panacrunch** and **combination** cooking the walls of the oven should be cleaned with a soft cloth and soapy water. Particular care should be taken to keep the window area clean especially after cooking by **grill, oven, steam, Panacrunch** and **combination**. Stubborn spots inside the oven can be removed by using a small amount of conventional oven-cleaner sprayed onto a soft damp cloth. Wipe onto problem spots, leave for recommended time and then wipe off. **Do not spray directly inside the oven.**
4. After cooking with a **steam function**, wipe away any excess water which may have condensed within the oven cavity. Empty the drip tray (refer to page 14).
5. Do not use harsh abrasive cleaners or sharp metal scrapers to clean the **oven door glass** since they may scratch the surface, which may result in shattering of the glass.
6. The **outside oven surface** should be cleaned with a damp cloth. To prevent damage to the operating parts inside the oven, water should not be allowed to seep into the ventilation openings.
7. If the **control panel** becomes dirty, clean with a soft, dry cloth. **Do not** use harsh detergents or abrasives on control panel. When cleaning the control panel, leave the oven door open to prevent the oven from accidentally turning on. After cleaning touch Stop/Cancel to clear the display window.
8. **If steam accumulates** inside or around the outside of the oven door, wipe with a soft cloth. This may occur when the microwave oven is operated under high humidity conditions and in no way indicates a malfunction of the unit or microwave leakage.
9. The **oven cavity floor** should be cleaned regularly. Simply wipe the bottom surface of the oven with mild detergent and warm water then dry with a clean cloth. Cooking vapours collect during repeated use but in no way affect the bottom surface.
10. When **grilling** or cooking by **oven, steam** or **combination** some foods may splatter grease onto the oven walls. If the oven is not cleaned to eliminate this grease, it can accumulate and cause the oven to 'smoke' during use. These marks will be more difficult to clean later.
11. A **steam cleaner** is not to be used for cleaning the appliance.
12. Ensure the Square Panacrunch Pan is kept clean, especially when using microwave or combination programs.
13. Keep **air vents** clear at all times. Check that no dust or other material is blocking any of the air vents on the right side of the oven. If vents become blocked this could cause overheating which would affect the operation of the oven and possibly result in a hazardous situation.
14. Run the system cleaning program when the symbol shows in the display. See page 58. Clean the water tank at least once a week to prevent build up of limescale. See page 59.

Maintenance of your oven

Service

1. When your oven requires a service call your local Panasonic engineer (**Customer Communications Centre on 0344 344 3899** can recommend an engineer).



Warning!

It is hazardous for anyone other than a competent person to carry out any service or repair operation which involves the removal of a cover which gives protection against exposure to microwave energy.

Door seals

2. Do not attempt to tamper with or make any adjustments or repairs to door, control panel housing, safety interlock switches or any other part of the oven. Do not remove outer panel from oven. The door seals and door seal areas should always be kept clean – use a damp cloth.



Warning!

The appliance should be inspected for damage to the door seals and door seal areas. If these areas are damaged the appliance should not be operated until it has been repaired by a service technician trained by the manufacturer.

Water tank

3. Do not use the water tank if it is cracked or broken, as leaking water could result in electrical failure and danger of electric shock. If the water tank becomes damaged, please contact your dealer.

Oven light

4. The oven lamp must be replaced by a service technician trained by the manufacturer. **Do not** attempt to remove the outer casing from the oven.

Selected spares and accessories

5. These may be ordered directly online at www.panasonic.co.uk or by telephoning the **Customer Communication Centre on 0344 344 3899**. Most major credit and debit cards accepted. Ensure you quote the correct model number.

Accessory advice

1. Do not cook food directly on the base of the oven. Always place food in a microwave safe dish.
2. The Square Panacrunch Pan provided must **only** be used as directed for **grilling, oven, steam, Panacrunch** and **combination** without microwave cooking. **Never use metal accessories when cooking in microwave only mode.** Do not use if operating the oven with less than 200 g of food on a manual combination program. The maximum weight that can be used on the oven accessory is 3.2 kg. Failure to use the accessory correctly could damage your oven.
3. When cooking with **microwave** power arcing may occur if the incorrect weight of food is used, a metal container has been used incorrectly, or the oven accessory has been damaged. If this occurs, stop the appliance immediately. You can continue to cook by **grill, steam** or **oven** only.
4. Always refer to instructions for correct accessory to use on all auto programs

Oven accessory

The oven comes equipped with an accessory, the Square Panacrunch Pan. Always follow the directions given for use of the accessory. The accessory has a number of uses:

1. It is recommended to use the pan in the upper shelf position on **Steam 1, 2 or 3**. For steaming larger food items, place the pan in the lower shelf position. During steaming, cooking juices collect in the watercourse of the pan.
2. The pan can be used for **grill** in the upper shelf position for small flat items. It can be used in the lower shelf position for grilling larger items.
3. The pan can be placed in the lower or upper shelf position to cook in **oven** mode 100 - 220 °C or 40 °C.
4. The pan can be used as a **Square Panacrunch Pan** in the upper shelf position for the Panacrunch auto programs. It can be used in the upper or lower shelf positions in manual operation for browning and crisping the top and base of foods.

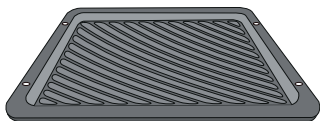

Square Panacrunch Pan

Using the Square Panacrunch Pan (Manual operation)

1. Place in the upper shelf position. Press Grill pad 4 times to select Panacrunch mode. Please refer to page 35.
2. Cook according to the guidelines shown in the cooking chart in the cookbook on page 35.
3. Use oven gloves after cooking as the pan will be very hot.

Care of the pan

1. Never use any sharp utensils on the pan as this will damage the non-stick surface.
2. After use, wash the pan in hot soapy water and rinse in hot water. Do not use any abrasive cleaning substances or scouring pads as this will damage the surface of the pan.
3. The pan is dishwasher safe.



Note

- Do not pre-heat the pan.
- Always use oven gloves when handling the hot pan.
- Ensure all food packaging is removed before cooking.
- Do not place any heat-sensitive materials on the hot pan as this may cause burning.
- For correct use of the Square Panacrunch Pan for each cooking mode, see pages 29-45.

Parts of your oven

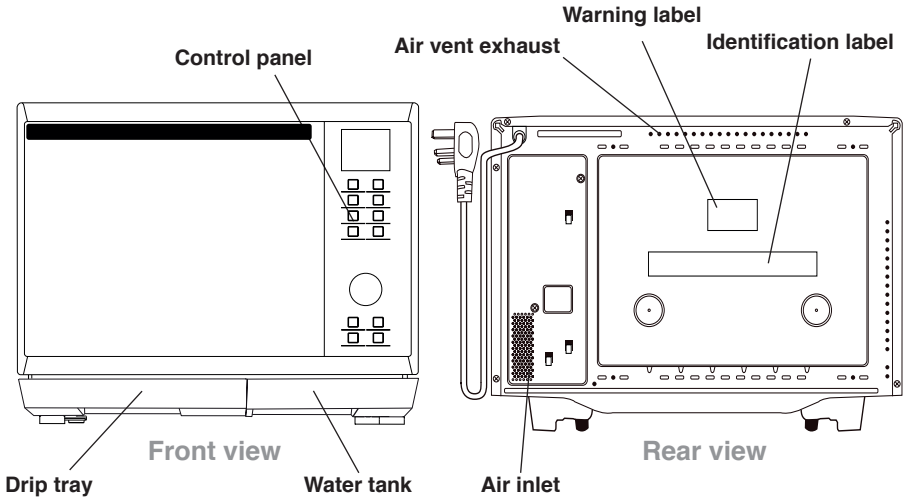

Drip tray

1. Before using the oven, the drip tray must be fitted as it collects excess water during cooking. The drip tray should be removed and cleaned on a regular basis.
2. Fit the drip tray by holding with both hands and clicking onto the front legs of the oven.
3. To remove the drip tray, hold with both hands and gently ease forward. Wash in warm soapy water. Re-position the drip tray by clicking back onto the legs.
4. **Do not use a dishwasher to clean the drip tray.**

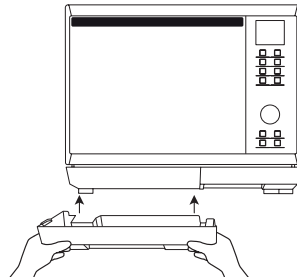

Re-position the drip tray by clicking back onto the legs.

Water Tank

Refer to guidelines for water tank on page 40.

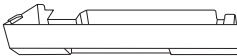

Drip tray

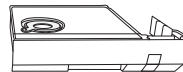

Water tank



Note

The above illustration is for reference only.

Parts of your oven

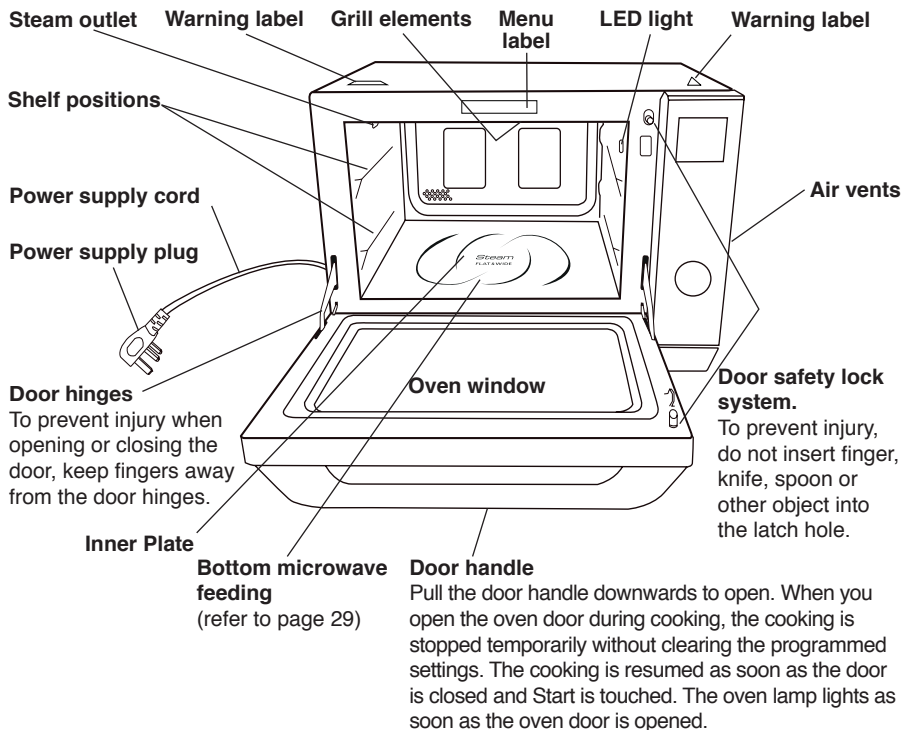

Note

The above illustration is for reference only.

Important information

Safety

If smoke is emitted or a fire occurs in the oven, touch Stop/Cancel and leave the door closed in order to stifle any flames. Disconnect the power cord, or shut off power at the fuse or the circuit breaker panel.

Short cooking times

As microwave cooking times are much shorter than other cooking methods it is essential that recommended cooking times are not exceeded without first checking the food.

Cooking times given in the cookbook are approximate. Factors that may affect cooking times are: preferred degree of cooking, starting temperature, altitude,

volume, size and shape of foods and utensils used. As you become familiar with the oven, you will be able to adjust these factors.

It is better to undercook rather than overcook foods. If food is undercooked, it can always be returned to the oven for further cooking. If food is overcooked, nothing can be done. Always start with minimum cooking times.



Important

If the recommended cooking times are exceeded the food will be spoiled and in extreme circumstances could catch fire and possibly damage the interior of the oven.

Important information

Small quantities of food

Take care when heating small quantities of food as these can easily burn, dry out or catch fire if cooked too long. Always set short cooking times and check the food frequently.



Note

Never operate the oven without food inside on microwave or combination mode involving microwave.

Foods low in moisture

Take care when heating foods low in moisture, e.g. bread items, chocolate, biscuits and pastries. These can easily burn, dry out or catch on fire if cooked too long. We do not recommend heating foods low in moisture such as popcorn or poppodums. The microwave oven is intended for heating food and beverages only. Drying of food, newspapers or clothing and heating of warming pads, slippers, sponges, damp cloth, wheat bags, hot water bottles and similar may lead to risk of injury, ignition or fire.

Christmas pudding

Christmas puddings and other foods high in fats or sugar, e.g. jam, mince pies, must not be overheated. These foods must never be left unattended as with over cooking these foods can ignite.

Boiled eggs

Eggs in their shell and whole hardboiled eggs should not be heated in microwave ovens since they may explode even after microwave heating has ended.

Foods with skin

Potatoes, apples, egg yolk, whole vegetables and sausages are examples of foods with non porous skin. These must be pierced using a fork before cooking to prevent bursting.



Warning

Liquids and other foods must not be heated in sealed containers since they are liable to explode.

Liquids

When heating liquids, e.g. soup, sauces and beverages in your microwave oven, overheating the liquid beyond boiling point can occur without evidence of bubbling.

This could result in a sudden boil over of the hot liquid. To prevent this possibility the following steps should be taken:

- Avoid using straight-sided containers with narrow necks.
- Do not overheat.
- Stir the liquid before placing the container in the oven and again halfway through the heating time.
- After heating, allow to stand in the oven for a short time, stirring again before carefully removing the container.

Microwave heating of beverages can result in delayed eruptive boiling, therefore care should be taken when handling the container.

Lids

Always remove the lids of jars and containers and takeaway food containers before you microwave them. If you don't then steam and pressure might build up inside and cause an explosion even after the microwave cooking has stopped.

Deep fat frying

Do not attempt to deep fat fry in your oven.

Meat thermometer

Use a meat thermometer to check the degree of cooking of roasts and poultry only when meat has been removed from the microwave. If undercooked, return to the oven and cook for a few more minutes at the recommended power level. Do not leave a conventional meat thermometer in the oven when microwaving.

Important information

Paper, plastic

When heating food in plastic or paper containers, keep an eye on the oven due to the possibility of ignition. Do not use wire twist-ties with roasting bags when cooking mode includes microwave power as arcing will occur. Do not use recycled paper products, e.g. kitchen roll unless they say they are specifically designed for use in a microwave oven. These products contain impurities which may cause sparks and/or fires when used.

Reheating

It is essential that reheated food is served "piping hot". Remove the food from the oven and check that it is "piping hot", i.e. steam is being emitted from all parts and any sauce is bubbling. (If you wish you may choose to check the food has reached 72 °C with a food thermometer – but remember do not use this thermometer inside the microwave.)

For foods that cannot be stirred, e.g. lasagne, shepherds pie, the centre should be cut with a knife to test it is well heated through. Even if a manufacturer's packet instructions have been followed always check the food is piping hot before serving and if in doubt return your food to the oven for further heating.

Standing time

Standing time refers to the period at the end of cooking or reheating when food is left before being eaten, i.e. it is a rest time which allows the heat in the food to continue to conduct to the centre, thus eliminating cold spots.

Keeping your oven clean

It is essential for the safe operation of the oven that it is wiped out regularly. Use warm soapy water, squeeze the cloth out well and use to remove any grease or food from the interior. Pay particular attention to the door seal area. The oven should be unplugged when cleaning.

Grilling

The oven will only operate on the **grill** function with the door closed.

Fan motor operation

After using the microwave oven, the fan motor may operate to cool the electric components. This is normal and you can take out food even though the fan motor operates. You can continue using the oven during this time.

Utensils/containers

Before use check that utensils/containers are suitable for use in microwave ovens. See pages 22-23.

Babies bottles and food jars

When reheating babies bottles always remove top and teat. Liquid at the top of the bottle will be much hotter than that at the bottom and must be shaken thoroughly before checking the temperature. The lid must also be removed from babies food jars, the contents must also be stirred or shaken before the temperature is checked. This should be carried out before consumption in order to avoid burns. See page 60.

Arcing

Arcing may occur if a metal container has been used incorrectly, if the incorrect weight of food is used, or if the Square Panacrunch Pan has been damaged. Arcing is when blue flashes of light are seen in the microwave oven. If this occurs, stop the machine immediately. If the oven is left unattended and this continues it can damage the machine. You can continue to cook by **grill, oven or steam only**.

Microwaving principles

Microwaves are present in the atmosphere all the time, both naturally and from manmade sources. Manmade sources include radar, radio, television, telecommunication links and mobile phones.

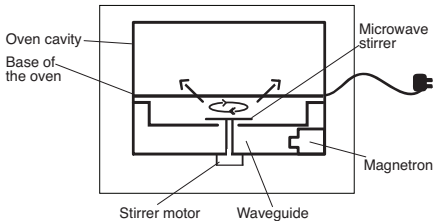

In a microwave oven, electricity is converted into microwaves by the **Magnetron**. For bottom feeding, please refer to page 29.

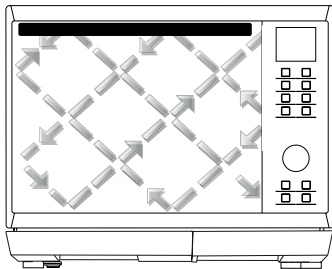

Reflection

The microwaves bounce off the metal walls and the metal door screen.

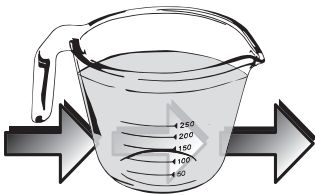

Transmission

Then they pass through the cooking containers to be absorbed by the water molecules in the food, all foods contain water to a more or lesser extent.



Important note

The dish used to cook or reheat the food will get warm during cooking, as the heat conducts from the food. Even in microwaving, oven gloves are required! **Microwaves can not pass through metal and therefore metal cooking utensils can never be used in a microwave, for cooking on microwave only.**

How microwaves cook food

The microwaves cause the water molecules to vibrate which causes **friction**, i.e. **heat**.

This heat then cooks the food.

Microwaves are also attracted to fat and sugar particles, and foods high in these will cook more quickly. Microwaves can only penetrate to a depth of 4-5 cm and as heat spreads through the food by conduction, just as in a traditional oven, the food cooks from the outside inwards.

Foods not suitable for cooking by microwave only

Yorkshire pudding and souffles. This is because these foods rely on dry external heat to cook correctly, do not attempt to cook by microwave.

Foods that require deep fat frying cannot be cooked either.

Standing time

When a microwave oven is switched off, the food will continue to cook by conduction – **not by microwave energy**. Hence **standing time** is very important in microwaving, particularly for dense foods i.e. meat, cakes and reheated meals (refer to page 20).



Boiled eggs

Do not boil eggs in your microwave. Raw eggs boiled in their shells can explode and cause serious injury.

Control panel

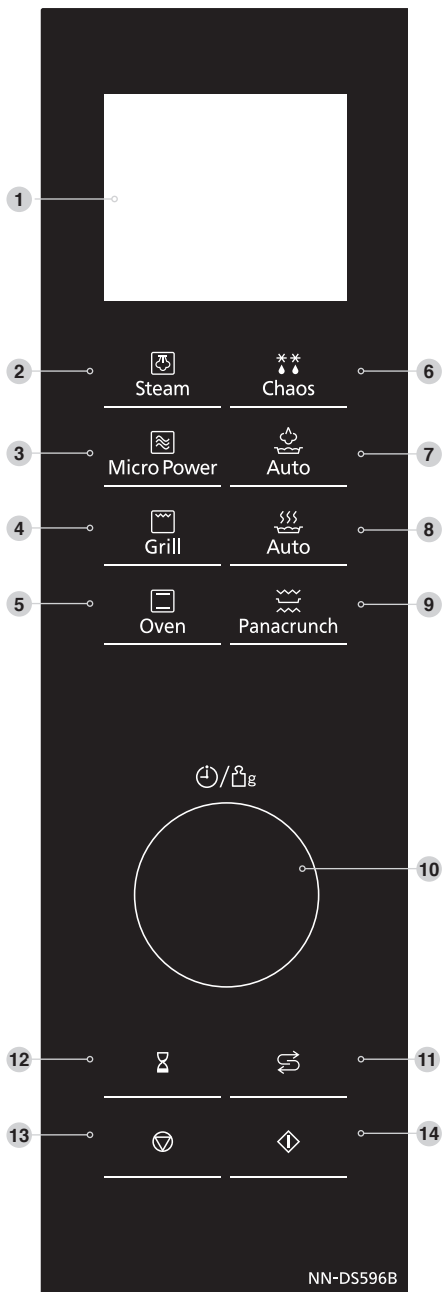

1. **Display window**
2. **Steam** (pages 39-40)
3. **Micro Power** (page 29)
4. **Grill** (pages 33-35)
5. **Oven** (pages 36-38)
6. **Chaos defrost** (pages 50-51)
7. **Auto steam programs** (pages 52-53)
8. **Auto cook programs** (pages 54-55)
9. **Panacrunch programs** (pages 56-57)
10. **Time/Weight Dial**
11. **System cleaning** (pages 58)
12. **Timer/Clock**
13. **Stop/Cancel:**

Before cooking:

One touch clears your instructions.

During cooking:

One touch temporarily stops the cooking program. Another touch cancels all your instructions and a colon or the clock will appear in the display.

14. **Start:**

Touch to start operating the oven. If during cooking the door is opened or Stop/Cancel is touched once, Start has to be touched again to continue cooking.



Beep sound:

A beep sounds when a key is touched. If this beep does not sound, the setting is incorrect. When the oven changes from one function to another, two beeps sound. After completion of cooking, five beeps sound.



Note

- The oven will enter stand-by mode after the last operation has completed. When in stand-by mode, the brightness of the display will be reduced.
- When in stand-by mode, it is necessary to open and close the oven door.
- If an operation is set and Start is not touched within 6 minutes, the oven will automatically cancel the operation. The display will revert back to colon or Clock mode.

General guidelines

Standing time

Dense foods e.g. meat, jacket potatoes and cakes, require a **standing time** (inside or outside of the oven) after cooking, to allow heat to finish conducting through the food.

■ Jacket potatoes

Wrap in aluminium foil once cooked by microwave only. Stand for 5 min. It is not necessary to stand jacket potatoes cooked in **combination** mode.

■ Fish

Stand for 2-3 minutes.

■ Egg dishes

Stand for 1-2 minutes.

■ Precooked convenience food

Stand for 2-3 minutes.

■ Meat joints

Stand 15 min wrapped in aluminium foil.

■ Plated meals

Stand for 2-3 minutes.

■ Vegetables

Boiled potatoes benefit from standing for 1-2 minutes, however most other types of vegetables can be served immediately.

■ Defrosting

It is essential to allow standing time to complete the process. This can vary from 5 minutes. e.g. raspberries, to 1-2 hours for a joint of meat. See pages 31-32.

If food is not cooked after **standing time**, return to oven and cook for additional time.



Moisture content

Many fresh foods e.g. vegetables and fruit, vary in their moisture content throughout the season. Jacket potatoes are a particular example of this. For this reason cooking times may have to be adjusted throughout the year. Dry ingredients e.g. rice, pasta, can dry out during storage so cooking times may differ from ingredients freshly purchased.



Piercing

The skin or membrane on some foods will cause steam to build up during cooking. These foods must be pierced or a strip of skin should be peeled off before cooking to allow the steam to escape. Eggs, potatoes, apples, sausages etc, will all need to be pierced before cooking. **Do not attempt to boil eggs in their shells.**



Cling film

Cling film helps keep the food moist and the trapped steam assists in speeding up cooking times. However it should be pierced before cooking, to allow excess steam to escape. Always take care when removing cling film from a dish as the build-up of steam will be very hot. Always purchase cling film that states on the packet "suitable for microwave cooking" and use as a covering only. Do not line dishes with cling film. Do not cover foods when cooking by **grill, oven or combination**.

General guidelines

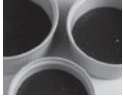

Dish size

Follow the dish sizes given in the recipes, as these affect the cooking and reheating times. A quantity of food spread in a bigger dish cooks and reheats more quickly



Quantity

Small quantities cook faster than large quantities, also small meals will reheat more quickly than large portions.



Spacing

Foods cook more quickly and evenly if spaced apart. **Never** pile foods on top of each other.



Shape

Even shapes cook evenly. Food cooks better by microwave when in a round container rather than square.



Density

Porous airy foods heat more quickly than dense heavy foods.



Covering

Cover foods with microwave cling film or a self-fitting lid. Cover fish, vegetables, casseroles, soups. Do not cover cakes, sauces, jacket potatoes, pastry items. Please refer to cooking charts and recipes for more information.



Arranging

Individual foods e.g. chicken portions or chops, should be placed in a dish so that the thicker parts are to the outside.



Ingredients

Foods containing fat, sugar or salt heat up very quickly. The filling may be much hotter than the pastry. Take care when eating. **Do not** overheat even if the pastry does not appear to be very hot.



Starting temperature

The colder the food, the longer it takes to heat up. Food from a fridge takes longer to reheat than food at room temperature. Food temperature should be between 5-8 °C before cooking.



Turning and stirring

Some foods require stirring during cooking. Meat and poultry should be turned after half the cooking time.



Liquids

All liquids must be stirred **before, during and after heating**. Water especially must be stirred before and during heating, to avoid eruption. Do not heat liquids that have previously been boiled. **Do not overheat**.



Checking food

It is essential that food is checked during and after a recommended cooking time, even if an **auto program** has been used (just as you would check food cooked in a conventional oven). Return the food to the oven for further cooking if necessary.



Cleaning

As microwaves work on food particles, keep your oven clean at all times. Stubborn spots of food can be removed by using a branded oven cleaner, sprayed onto a soft cloth. Always wipe the oven dry after cleaning. Avoid any plastic parts and door area. Customers should not spray directly into the cavity.

Quick check guide to cooking utensils



Choosing the correct container is a very important factor in deciding the success or failure of your cooking.

Testing dishes for suitability - for microwave cooking only.

When unsure that a cooking container is suitable for use in your microwave, check by the following test:

1. Fill a microwave safe measuring jug with 300 ml cold water.
2. Place it on the base of the oven along side the dish to be tested. If the dish you are testing is a large dish, then stand the measuring jug on top of the empty dish.
3. Heat on **high** power for 1 minute.



Result

If the dish is suitable for microwaving, it will remain cool, whilst the water in the jug will begin to feel warm. If the testing dish feels warm, do not use as it is obviously absorbing microwave energy.



Note

This test does not apply to plastic or metal based containers e.g. Le Creuset® style dishes, which should not be used as they are cast iron covered with enamel.

Containers to use



Oven glass

Everyday glass that is heat resistant e.g. Pyrex®, is ideal for microwave, oven or combination cooking. Do not use delicate glass or lead crystal which may crack or arc.



China and ceramic

Everyday glazed china, porcelain or ceramic plates, bowls, mugs and cups can be used if they are heat resistant. Fine bone china should only be used for reheating for short periods. Do not use dishes with a metal rim or pattern. Do not use jugs or mugs with glued handles, since the glue can melt. If dishes are heat resistant they may be used on Oven and Combination but not directly under the Grill.



Pottery, earthenware, stoneware

If completely glazed, these dishes are suitable. Do not use if partially glazed or unglazed, since they are able to absorb water which in turn absorbs microwave energy, making the container very hot and slows down the cooking of food.



Foil/metal containers

Never attempt to cook in foil or metal containers on microwave only as the microwaves cannot pass through and the food will not heat evenly, it may also damage your oven. Foil and metal containers can be used on grill or oven.

Containers to use



Plastic

Many plastic containers are designed for microwave use, but do not use for cooking foods high in sugar or fat or for foods that require long cooking times e.g. brown rice. Only use Tupperware® containers if they are designed for microwave use.



Do not use Melamine. Never cook in margarine cartons or yoghurt pots, as these will melt with the heat from the food. If heatproof they can be used for Oven or Combination cooking. **Do not use under the grill.**



Paper

Plain white absorbent kitchen paper (kitchen towel) can only be used for microwave cooking e.g. for covering bacon to prevent splattering.

Only use for short cooking times. Never re-use a piece of kitchen towel. Always use a fresh piece of paper for each dish.

Avoid kitchen paper containing manmade fibres.

If you are using branded re-cycled kitchen towel, check first that it is recommended for microwave use. Do not use waxed or plastic coated cups or plates as the finish may melt. Greaseproof paper can be used to line the base of dishes and to cover when blind baking pastry cases. White paper plates can be used for **short reheating times**, on Microwave only.



Cling film

Microwave cling film can only be used for covering food that is reheated by microwave.

It is also useful for covering food to be cooked, but care should be taken to avoid the film being in direct contact with the food eg. Do not line dishes with cling film. **Do not use on any other cooking mode.**



Aluminium foil

Small amounts of smooth aluminium foil can be used to **shield** joints of meat during defrosting and cooking by Microwave, as the microwaves cannot pass through the foil, this prevents the parts shielded from overcooking or over defrosting. Take care that the foil does not touch the sides or roof of the oven, as this may cause arcing and damage your oven. Aluminium foil can be used for Oven cooking.



Roasting bags

Roasting bags are useful when slit up one side to tent a joint, for roasting by power and time. Do not use the metal twists supplied, when using Microwave or Combination.

Cooking modes

The diagrams shown below are examples of the accessories. It may vary depending on recipe/dish used. Further information can be found in the cookbook.

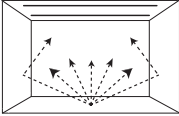
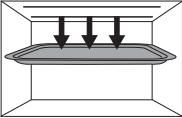
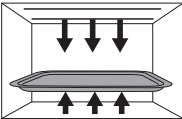
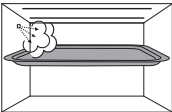
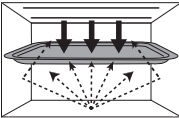
Cooking modes	Uses	Accessories to use	Containers
<p>MICROWAVE</p> 	<ul style="list-style-type: none"> ■ Defrosting ■ Reheating ■ Melting: butter, chocolate, cheese. ■ Cooking fish, vegetables, fruits, eggs. ■ Preparing: stewed fruits, jam, sauces, custards, choux, pastry, caramel, meat, fish. ■ Baking cakes without colour. <p>No Preheating</p>	-	Use your own Pyrex® dishes, plates or bowls, directly on the base of the oven. Microwaveable, no metal.
<p>GRILL</p> 	<ul style="list-style-type: none"> ■ Grilling of meat or fish. ■ Toast grilling. ■ Colouring of gratin dishes or meringue pies. <p>Preheating advised</p>	Square Panacrunch Pan.	Heatproof, metal tin can be used on Square Panacrunch Pan in lower or upper shelf positions or on base of oven.
<p>OVEN</p> 	<ul style="list-style-type: none"> ■ Baking of small items with short cooking times: puff pastry, cookies, roll cakes, scones. ■ Special baking: bread rolls or brioches, sponge cakes. ■ Baking of pizzas and tarts. <p>Preheating advised</p>	Square Panacrunch Pan.	Heatproof, metal tin can be used on Square Panacrunch Pan in lower or upper shelf positions. Do not place dishes directly on base of oven.
<p>STEAM</p> 	<ul style="list-style-type: none"> ■ Cooking fish, vegetables, chicken, rice, and potatoes. <p>No Preheating</p>	Square Panacrunch Pan.	Heatproof container on Square Panacrunch Pan in upper or lower shelf positions.
<p>PANACRUNCH</p> 	<ul style="list-style-type: none"> ■ Roasting small meat and poultry items. ■ Reheating and crisping (pizza, bread, potato products). <p>No Preheating</p>	Square Panacrunch Pan in upper or lower shelf positions.	-

Combination cooking modes

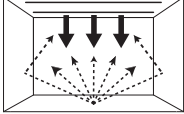
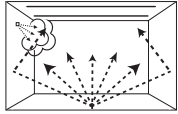
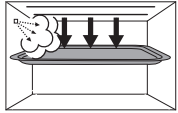
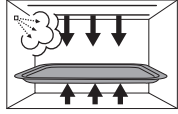
Cooking modes	Uses	Accessories to use	Containers
<p>GRILL + MICROWAVE</p>  <p>To use grill + microwave in Panacrunch mode, refer to page 24</p>	<ul style="list-style-type: none"> ■ Cooking lasagne, meat, potatoes or vegetable gratins. <p>No Preheating</p>	-	Microwaveable and heatproof dishes placed directly on base of oven.
<p>STEAM + MICROWAVE</p> 	<ul style="list-style-type: none"> ■ Cooking fish, vegetables, chicken, rice, and potatoes. <p>No Preheating</p>	-	Microwaveable and heatproof dishes placed directly on base of oven.
<p>GRILL + STEAM</p> 	<ul style="list-style-type: none"> ■ Cooking gratins ■ Kebabs ■ Fish fillets ■ Whole fish ■ Part baked bread <p>No Preheating</p>	Square Panacrunch Pan.	Microwaveable and heatproof. Dishes can be used on the Square Panacrunch Pan in the lower or upper shelf positions or directly on the base of the oven.
<p>OVEN + STEAM</p> 	<ul style="list-style-type: none"> ■ Baking cakes ■ Pastry tarts <p>Preheating advised</p>	Square Panacrunch Pan.	Microwaveable and heatproof. Dishes can be used on the Square Panacrunch Pan in the lower or upper shelf positions. Do not place dishes directly on base of oven.

Let's start to use your oven

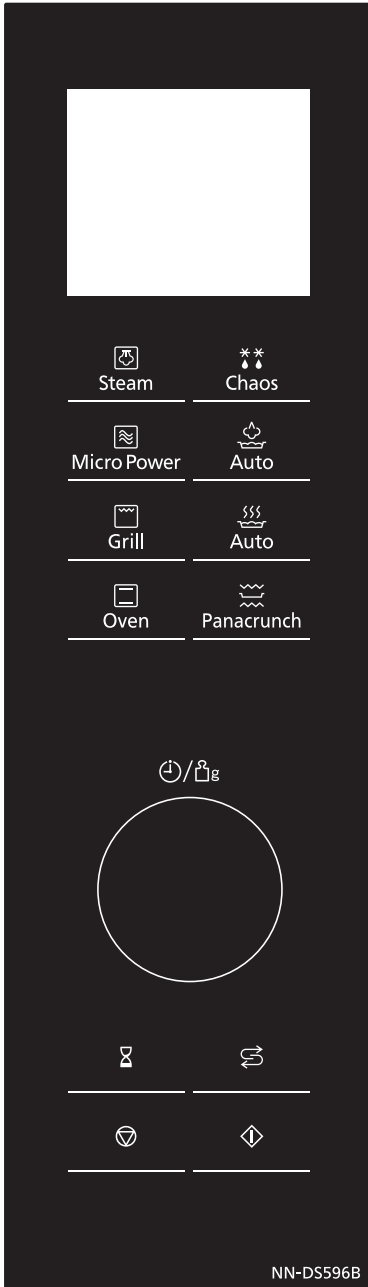

1 Plug in

Plug into a 13 amp fused electrical socket. You will be reminded to read your operating instructions.

2 Tap Timer/Clock twice to set clock

Set clock as a 24 hr clock. (See page 27 for details).

3 Tap Oven

() will appear in the display window with the oven temperature) (this procedure is to burn off the oil used for rust protection in the oven.) Tap Oven until 220 °C is in the display window. Remove all accessories from the oven.

4 Enter Time

Turn Time/Weight dial until 10 minutes is displayed in the window.

5 Touch Start

The time will be displayed in the window and count down. The oven will beep at the end of the program. The oven is now ready to use.



Caution

Grill elements and oven will be hot.



Note

This is to enable you to experiment setting various programs. ("DEMO MODE PRESS ANY KEY" will appear in the display window. This is to confirm that there is no microwave power produced and it is safe to use the oven without any food). To set Demonstration Mode: tap Microwave power once, then tap Stop/Cancel 4 times. To cancel Demonstration Mode touch Microwave power once, touch Stop/Cancel 4 times.

NN-DS596B

Setting the clock

When the oven is first plugged in “REFER TO OPERATING INSTRUCTIONS BEFORE USE” appears in display window.

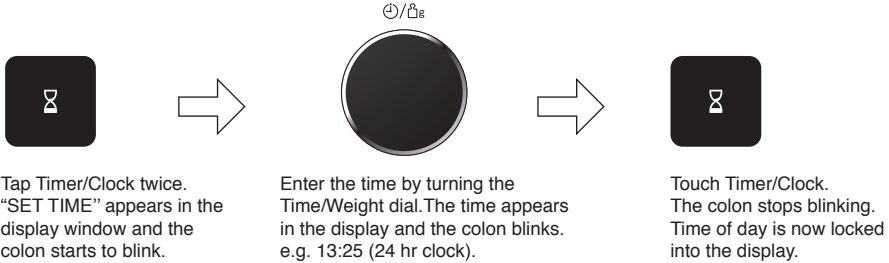

Note

1. One turn of the dial will increase or decrease the time by 1 minute. Continuously turning the dial will rapidly increase or decrease the time.
2. To reset the time of day repeat all the above steps.
3. The clock will keep the time of day as long as the oven is plugged in and electricity is supplied.
4. This is a 24 hour clock.

Child lock

Using this system will make the oven controls inoperable; however, the door can be opened. Child lock can be set when the display shows a colon or the time.

To Set:



Tap Start three times.
The time of day will disappear.
Actual time will not be lost.
'LOCK' is indicated in the display.

To Cancel:



Tap Stop/Cancel three times.
The time of day will reappear in the display.



Note

To activate child lock, Start must be tapped 3 times within a 10 second period. Child Lock can be set when a colon or the time of day is displayed.

Operation guide setting

To assist you in programming your oven, the following operation will appear in the display window. When you become familiar with your oven, the operation guide can be turned off.

To turn off:



OPERATION GUIDE OFF



Colon or time of day appears in the display window.

Tap Timer/Clock four times.

Display window

To turn on:



OPERATION GUIDE ON



Colon or time of day appears in the display window.

Tap Timer/Clock four times.

Display window

Microwave cooking and defrosting



There are 6 different microwave power levels available. Do not place food directly on the base of the oven. Use your own dishes, plates or bowls covered with a lid or pierced cling film directly on the base of the oven.



Touch	Power Level	Wattage
Once	High	1000 W
Twice	Defrost	270 W
3 Times	Medium	600 W
4 Times	Low	440 W
5 Times	Simmer	300 W
6 Times	Warm	100 W

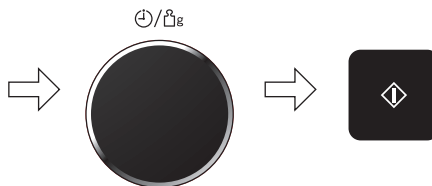

Tap Micro Power until the power you require appears in the display window.

Select the cooking time by turning the Time/Weight dial.

Touch Start. The cooking program will start and the time in the display will count down.



Note

1. Maximum time that can be set on HIGH power is 30 minutes. On all other power levels the maximum time that can be set is 1 hour 30 minutes.
2. You can change the cooking time during cooking if required. Turn dial to increase or decrease the cooking time. Time can be increased/decreased in 1 minute increments, up to 10 minutes. Turning dial to zero will end cooking.
3. **Do not** attempt to use microwave only with any metal container in the oven.
4. **Do not** place food directly onto the base of the oven. Place in a microwaveable or glass dish. Foods reheated or cooked by **microwave** only should be covered with a lid or pierced cling film, unless otherwise stated.
5. For manual defrosting times, please refer to defrost chart on pages 31-32.
6. For multi-stage cooking refer to pages 46-47.
7. Stand time can be programmed after microwave power and time setting. Refer to using the timer page 48-49.

Bottom feeding technology

Please note that this product uses bottom feeding technology for microwave distribution which differs from traditional turntable side feeding methods and creates more useable space for a variety of different sized dishes.

This microwave feeding style can give a difference in heating times (in microwave mode) when compared against side feeding appliances. This is quite normal and should not cause any concern. Please refer to the reheating and cooking charts on pages 61-75.

Defrosting guidelines



By selecting the **defrost** power level from the microwave power key and setting a time, you can defrost food in your microwave. The biggest problem is getting the inside defrosted before the outside starts to cook.

For this reason a defrost program alternates between a defrost power and a standing time. The name for this type of defrost is cyclic. During the standing stages there is not any microwave power in the oven, although the light will remain on.

The automatic stand times ensure a more even defrost but it is still necessary to allow for standing times before use.

For Best Results

1. Place foods in a suitable container. Meat joints and chickens should be placed on an upturned saucer or on a plastic rack if you have one.
2. Check food during defrosting, as foods vary in their defrosting speed.
3. It is not necessary to cover the food.
4. Always turn or stir the food especially when the oven "beeps". Shield if necessary (see point 6).
5. Minced meat, chops, chicken portions and other small items should be broken up or separated as soon as possible and placed in a single layer.
6. Shielding prevents food cooking. It is essential when defrosting chickens and joints of meat. The outside thaws out first, so protect wings/breast and fat with smooth pieces of aluminium foil secured with cocktail sticks.
7. Allow standing time so that the centre of the food thaws out. (Minimum of 1 hour for joints of meat and whole chickens).



Arrange food in a single layer.



Turn or break up food as soon as possible.



Shield chickens and joints of meat.

Defrosting chart



Select Defrost power. The times given below are a guideline only. Always check the progress of the food by opening the oven door and then re-starting. For larger quantities adjust times accordingly. Food should not be covered during defrosting.

Food	Weight	Defrost Time	Method	Standing Time
Meat				
Beef/Lamb/ Pork Joint	700 g	19-20 mins	Place in a suitable dish or on an upturned saucer or use a rack. Turn 3-4 times.	60 mins
Beef/Lamb/ Pork Joint	1.0 kg	30 mins	Place in a suitable dish or on an upturned saucer or use a rack. Turn 4 times.	60 mins
Sirloin/ Rump Steak	500 g	14 mins	Place in a suitable dish. Separate and turn twice.	15 mins
Beefburgers	112 g (1)	3 mins	Place in a suitable dish. Turn.	10 mins
	227 g (2)	7 mins	Place in a suitable dish. Separate and turn twice.	15 mins
	454 g (4)	9 mins		30 mins
Minced Beef	500 g	14 mins	Place in a suitable dish. Break up and turn 3-4 times.	15 mins
Stewing Steak	400 g	13 mins	Place in a suitable dish in a single layer. Break up and turn twice.	30 mins
Lamb Chops	300 g	8 mins	Place in a suitable dish in a single layer. Turn twice.	15 mins
Lamb Shanks x 2	900 g	19 mins	Place in a suitable dish in a single layer. Separate and turn twice. Shield if necessary.	60 mins
Pork Ribs	700 g	16 mins	Place in a suitable dish. Separate and turn twice.	30 mins
Pork Chops	500 g	11 mins	Place in a suitable dish. Separate and turn twice.	20 mins
Bacon	300 g	9 mins	Place in a suitable dish. Separate and turn 2-3 times.	15 mins
Sausages	130 g (2)	4 mins	Place in a suitable dish. Turn.	15 mins
	540 g (8)	10-11 mins	Place in a suitable dish. Turn twice.	20 mins
Whole Chicken	1.5 kg	35 mins	Place in a suitable dish or on an upturned saucer or use a rack. Turn 3-4 times. Shield if necessary.	60 mins

Defrosting chart



Select Defrost power. The times given below are a guideline only. Always check the progress of the food by opening the oven door and then re-starting. For larger quantities adjust times accordingly. Food should not be covered during defrosting.

Food	Weight	Defrost Time	Method	Standing Time
Chicken Portions	160 g (1)	6 mins	Place in a suitable dish. Turn.	15 mins
	400 g (2)	9 mins	Place in a suitable dish. Turn twice.	30 mins
	700 g (4)	17 mins		60 mins
Duck Breast Fillets	400 g	12 mins	Place in a suitable dish. Turn twice.	30 mins
Whole Fish x 2	500 g	15 mins	Place in a suitable dish. Turn twice separate if necessary.	20 mins
Fish Fillets	100-150 g	4-5 mins	Place in a suitable dish. Separate if necessary and turn twice.	10 mins
	600 g	10 mins		30 mins
Fish Steaks	100 g	4 mins	Place in a suitable dish. Turn.	10 mins
	270 g	8 mins	Place in a suitable dish. Separate if necessary and turn twice.	15 mins
	500 g	12-14 mins		20 mins
Prawns	200 g	7 mins	Place in a suitable dish. Stir twice during defrosting.	15 mins
GENERAL				
Sliced bread	400 g	6 mins	Place on a plate. Separate and arrange during defrosting.	10 mins
	40 g	1 min 30 secs	Place on a plate.	5 mins
Soft fruit	500 g	13 mins	Place in a suitable dish. Stir twice during defrosting.	30 mins
Gateau	515 g	4 mins	Place on a plate.	20 mins
Cheesecake	500 g	7 mins	Place on a plate.	20 mins
Meringue dessert	450 g	4 mins	Place on a plate.	30 mins
Butter	250 g	4 mins	Place on a plate.	20 mins
Shortcrust/ Puff pastry	500 g	4 mins	Place on a plate. Turn halfway.	30 mins

Grilling



The grill system on the oven gives fast efficient cooking for a wide variety of foods e.g. chops, sausages, steaks, toast, etc.

There are 3 different grill settings available.



Touch	Power Level	Wattage
Once	Grill 1 (High)	1200 W
Twice	Grill 2 (Medium)	850 W
3 Times	Grill 3 (Low)	650 W
4 Times	Panacrunch (See page 35)	



Tap Grill until the power you require appears in the display window.

Touch Start to preheat.

A "P" will appear in the display window. When the oven is preheated the oven will beep and the "P" will flash. Then open the door and place the food inside.

* Skip this step when preheat is not required.

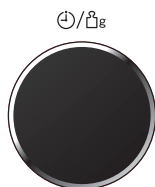

Select the cooking time by turning the Time/Weight dial. Maximum cooking time is 90 minutes.

Touch Start.

The cooking program will start and the time in the display will count down.



Note

1. The grill will only operate with the oven door closed.
2. You can change the cooking time during cooking if required. Turn the Time/Weight dial to increase or decrease the cooking time. Time can be increased/decreased in 1 minute increments, up to 10 minutes. Turning the dial to zero will end cooking.



Caution

The Square Panacrunch Pan and surrounding oven will get very hot. Use oven gloves.



Grilling times

When using the grill to cook foods, the cooking times will be similar to traditional grilling. Most foods will require turning halfway through the cooking time (see section on oven accessories page 34).



Oven accessory to use

When grilling fish, chops or small food items, the Square Panacrunch Pan should be placed in the upper shelf position. For larger food items, the Square Panacrunch Pan should be in the lower shelf position.

Place food on Square Panacrunch Pan

The Square Panacrunch Pan will allow fat and juices to drip into the Watercourse to reduce excess splatter and smoke when grilling.

Most foods require turning halfway during cooking. When turning food, open oven door and **carefully** remove the Square Panacrunch Pan by holding firmly.

Use oven gloves when removing the Square Panacrunch Pan as it will be very hot, and so will the roof and walls of the oven.

After turning, return food to the oven, close door and touch Start. The oven will continue to count down the remaining cooking time. It is quite safe to open the oven door at any time to check the progress of the food as it is grilling.

Guidelines

1. Use the Square Panacrunch Pan provided, as explained.
2. Most meat items e.g. bacon, sausages, chops can be cooked on the hottest setting **grill 1**. This setting is also suitable for toasting bread, muffins and teacakes etc.
3. **Grill 2** and **grill 3** are used for more delicate foods or those that require a longer grill time e.g. fish or chicken portions.
4. **Never cover the food when grilling.**
5. Always use oven gloves when removing the food and Square Panacrunch Pan after grilling as they will be very hot.
6. After grilling it is important that the Square Panacrunch Pan is removed for cleaning before reuse and that the oven walls and floor are wiped with a cloth squeezed in hot soapy water to remove any grease.



Dishwasher safe

The Square Panacrunch Pan is dishwasher safe.



Panacrunch (Grilling)



The Panacrunch 'concept'

Some foods cooked by microwave can have soft and soggy crusts. Your Square Panacrunch Pan accessory will brown and crisp pizzas, frozen potato products, quiches, pies, breaded products. Your Panasonic Square Panacrunch Pan works by heating the pan by absorbing microwaves and heating the food by the Grill. The base of the pan absorbs the microwaves and transfers them into heat. Then the heat is conducted through the pan to the food. The heating effect is maximised by the non-stick surface.

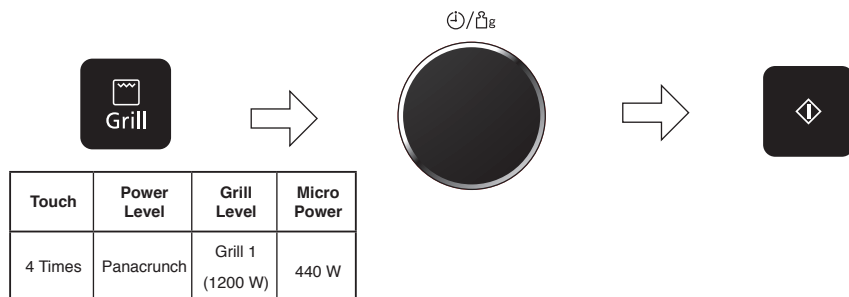

Tap Grill 4 times. The Panacrunch icon will appear in the display.

Select the cooking time by turning the Time/Weight dial. Maximum cooking time is 30 minutes.

Touch Start. The cooking program will start and the time in the display will count down.



Important

To use Panacrunch with grill level 2 or 3 or Low (440 W) or Simmer (300 W); First tap Grill to select desired grill level. Next tap Micro Power to select Low (440 W) or Simmer (300 W). Then select the cooking time and touch Start.

Suggested cooking options

Food	Weight	Power level	Shelf level	Cooking time
Frozen deep pan pizza	440 g	Panacrunch	Lower	10 mins
Frozen thin and crispy pizza	335 g	Panacrunch	Upper	7-8 mins
Chilled sausage roll	160 g (1)	Panacrunch	Upper	6-7 mins
Croissants / brioche (room temp.)	any	Panacrunch	Upper	4 mins
Chilled onion bhajis / samosas	200 g	Panacrunch	Upper	5 mins
Chilled breaded fish	255 g (2)	Panacrunch	Upper	6 mins



Caution

The Square Panacrunch Pan and surrounding oven will get very hot. Use oven gloves.

Oven cooking



Your combination oven can be used as an oven using the oven mode which uses top and bottom heat. For best results always place food in a preheated oven. When using oven mode, the Square Panacrunch Pan can be placed in the upper or lower shelf position.

See individual guidelines on pages 37-38 for recommended use.

Do not pre-heat on oven mode with the Square Panacrunch Pan in position.





Tap Oven. The oven starts at 150 °C. Tap Oven and the temperature will count up in 10 °C stages to 220 °C, then 40 °C and 100 °C.

Touch Start to preheat. A "P" will appear in the display window. When the oven is preheated the oven will beep and the "P" will flash. Then open the door and place the food inside.
** Skip this step when preheating is not required.*

Select the cooking time turning the Time/Weight dial. Maximum cooking time is 90 minutes.



Touch Start.

Note: Check that only the oven symbol  is still in the display. If the microwave symbol  is displayed this is incorrect and the program should be cancelled. Reselect the Oven setting.



Caution

The Square Panacrunch Pan and surrounding oven will get very hot. Use oven gloves.



Note

1. Open the door using the pull down door because if Stop/Cancel is touched the program may be cancelled.
2. The oven can not preheat to 40 °C.
3. You can change the cooking time during cooking if required. Turn the Time/Weight dial to increase or decrease the cooking time. Time can be increased/decreased in 1 minute increments, up to 10 minutes. Turning the dial to zero will end cooking.
4. After touching Start, the selected temperature can be recalled and changed. Touch Oven once to indicate the temperature in the display window. While the temperature is recalled in the display window, you can change the temperature by tapping oven.
5. The oven will maintain the selected preheated temperature for approximately 30 minutes. If no food has been placed inside the oven or a cooking time set, then it will automatically cancel the cooking program and revert to colon or time of day.

Oven cooking



In oven mode, you can cook food directly on the Square Panacrunch Pan in the upper or lower shelf position. Or you can place your standard metal baking tins and ovenware on the Square Panacrunch Pan in the lower shelf position. Do not place tins and ovenware directly on the base of the oven in oven mode.

Roasting meat: Square Panacrunch Pan in lower shelf position.



Baking: Square Panacrunch Pan in lower shelf position.



You can use the Square Panacrunch Pan as a baking dish for roasting potatoes or vegetables, and for baking fairy cakes, scones and cookies. It is also ideal for re-heating pre-cooked convenience pastry items.

Roasting Vegetables / Potatoes: Square Panacrunch Pan in lower shelf position.



Reheating: Square Panacrunch Pan in lower shelf position.



Caution

The Square Panacrunch Pan and surrounding oven will get very hot. Use oven gloves.

Oven cooking



Guideline to oven temperatures

For best results always place food in a preheated oven.

Don't forget that for ease of programming of the most commonly used temperatures, your oven will start at 150 °C and count up in 10 °C stages to 220 °C, then back to down to 40 °C then 100 °C. Food is generally cooked **uncovered** - unless it is stated in the instructions or recipe.

Temp °C	Use	Temp °F	Gas mark
40 °C	Proving Bread or Pizza dough	90 °F	½
150/160 °C	Macaroons	300 °F	2
160/170 °C	Casseroles, Small Tarts, Cookies	325 °F	3
180 °C	Victoria Sandwich, Fairy Cakes, Meat Joints	350 °F	4
190 °C	Gratins, Lasagne, Pastry Pies, Chicken	375 °F	5
200 °C	Stuffed Peppers, Scones, Swiss Roll, Muffins	400 °F	6
220 °C	Vegetable parcels, bread, garlic bread, roast potatoes, baking pizza.	425 °F	7

Steam cooking



The oven can be programmed as a steamer to cook vegetables, fish, chicken and rice. There are 3 different steam settings available.

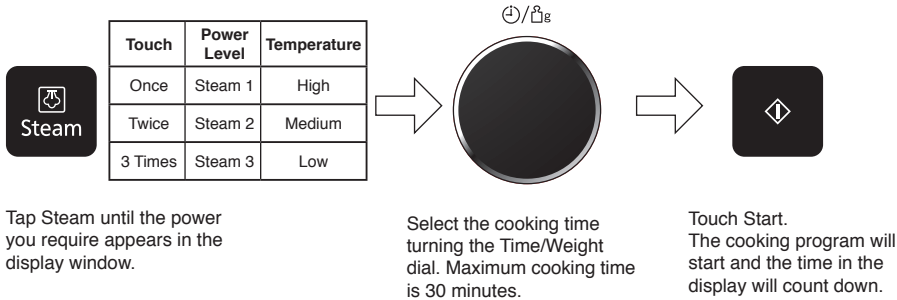

Note

1. Fill the water tank before using the **steam** function.
2. The maximum time for cooking in this mode is 30 minutes. If required to cook for longer than this time, re-fill the water tank and repeat the above operation for the remaining time.
3. If during operation the water tank becomes empty, the oven will stop operation. The prompt in the display will ask you to re-fill the water tank. After re-filling the water tank and positioning back in the oven, touch Start. The oven will not continue cooking until the water tank has been re-filled and Start touched.
4. You can change the cooking time during cooking if required. Turn the Time/Weight dial to increase or decrease the cooking time. Time can be increased/decreased in 1 minute increments, up to 10 minutes. Turning the dial to zero will end cooking.
5. It is possible to refill the water tank at any time during cooking, without having to touch Stop/Cancel first.
6. It may be necessary to wipe the excess water in the cavity after **Steam** cooking.



Caution

The Square Panacrunch Pan and surrounding oven will get very hot. Use oven gloves.

When removing the food or Square Panacrunch Pan, hot water may drip from the oven top.

Steam may billow out when you open the door. If there is steam in the oven, do not reach in with your bare hands! Risk of burns! Use oven gloves.

Take care when removing the drip tray. Wipe any water that drips from the left side of the oven. This is normal.

Steam cooking



Guidelines for water tank

Carefully remove the water tank from the oven. Remove the lid and fill with tap water (do not use mineral water). Replace the lid and position back in the oven. Ensure the lid is closed tightly and securely positioned, otherwise leakage may occur. It is recommended to clean the water tank in warm water once a week.

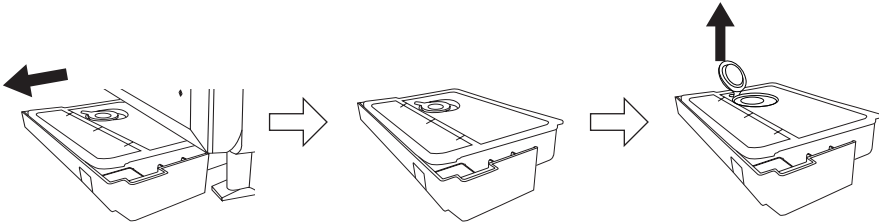

Caution

The Square Panacrunch Pan and surrounding oven will get very hot. Use oven gloves.



Guidelines

1. There is no microwave power on the **steam** only program.
2. Use the Square Panacrunch Pan provided, as explained below.
3. The **steam** will only operate with the oven door below.
4. **During and after cooking with steam function, do not open the oven door when your face is very close to the oven. Care must be taken when opening the door as steam may cause injury.**
5. Always use oven gloves when removing the food and Square Panacrunch Pan after steaming as they will be very hot.
6. After each steam operation carefully remove the drip tray from the front of the oven. Gently ease forwards, holding with both hands. After emptying, wash in warm soapy water. To re-position, click back into position on the oven legs. (See page 14)

Use of accessory

When **steaming** place food directly on the Square Panacrunch Pan in the upper shelf position. For steaming larger food items, place the Square Panacrunch Pan in the lower shelf position. During steaming, cooking juices collect in the watercourse of the pan.

Use oven gloves when removing the Square Panacrunch Pan as it will be very hot, and so will the roof and walls of the oven.



Steam Shot

This feature allows you to add steam during cooking (for 1, 2 or 3 minutes). There are 5 combinations that you can use steam shot:-

- MICROWAVE
- GRILL
- OVEN
- GRILL + MICROWAVE
- PANACRUNCH

Adding steam during cooking enhances the heat distribution and aids the rising process of breads, cakes and pastries.

Set and operate the desired program.



Optional

As required during operation, hold Steam for 2 seconds and 1 minute will be added.

If you want to add 2 or 3 minutes, tap Steam 2 or 3 times within 3 seconds after step 2. The remaining time displayed includes steam shot time.



Note

Steam shot is not available during preheating mode or at 40 °C oven.

Fill the water tank before use.

The original program still counts down when operating steam shot.

The steam shot time can not exceed the remaining cooking time.

If adding 2 or 3 minutes, **steam** must be tapped 2 or 3 times within a 3 second time period.

Wipe away excess water in the cavity and around the water tank after cooking with steam.



Caution

The Square Panacrunch Pan and surrounding oven will get very hot. Use oven gloves.

When removing the food or Square Panacrunch Pan, hot water may drip from the oven top.

Steam may billow out when you open the door. If there is steam in the oven, do not reach in with your bare hands! Risk of burns! Use oven gloves.

Food	Cooking mode	Steam Shot
Puff pastries	Oven	$\frac{2}{3}$ total time add 3 mins Steam Shot
Breads	Oven	$\frac{2}{3}$ total time add 3 mins Steam Shot
Sponge cakes	Oven	$\frac{1}{2}$ total time add 3 mins Steam Shot
Part baked rolls	Oven or Grill	$\frac{2}{3}$ total time add 3 mins Steam Shot

Combination cooking with steam

Steam can be used to cook foods simultaneously with microwave, grill or oven mode. This can often reduce traditional oven cooking times and keep the food moist.

Oven accessories to use



Steam + microwave

Directly on the base of the oven in a microwaveable and heatproof dish.

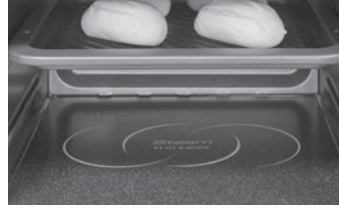

Oven or grill + steam

Square Panacrunch Pan in upper or lower shelf position.

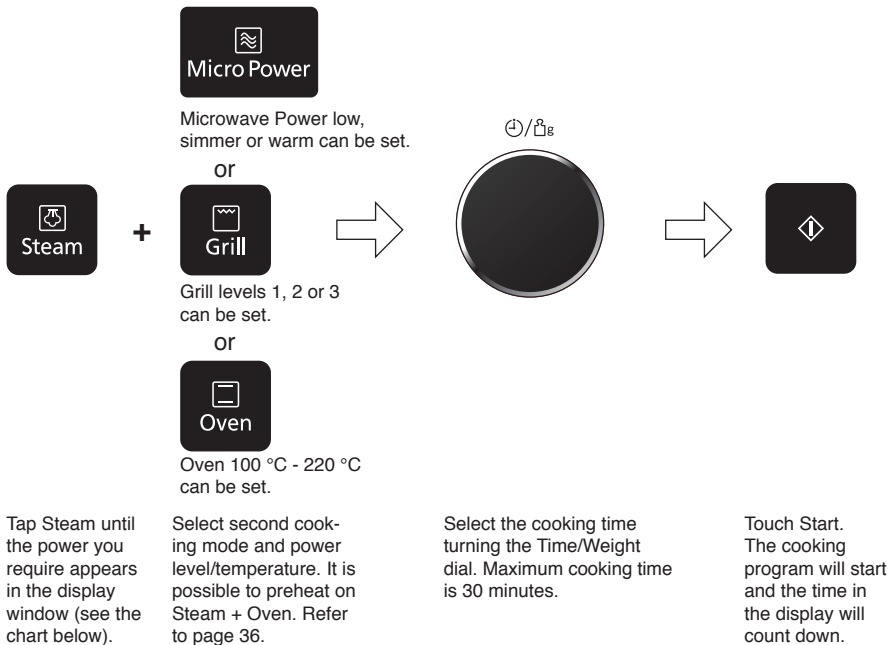

Power and temperature range

Touch	Power Level	Temperature
Once	Steam 1	High
Twice	Steam 2	Medium
3 Times	Steam 3	Low

Combination cooking with steam



Note

1. Fill the water tank before using the **steam** function.
2. The maximum time for cooking in this mode is 30 minutes. If required to cook for longer than this time, re-fill the water tank and repeat the above operation for the remaining time.
3. If during operation the water tank becomes empty, the oven will stop operation. The prompt in the display will ask you to re-fill the water tank. After re-filling the water tank and positioning back in the oven, touch Start. The oven will not continue cooking until the water tank has been re-filled and Start touched.
4. Preheating is not available with **steam + microwave** and **steam + grill** mode.
5. You can change the cooking time during cooking if required. Turn the Time/Weight dial to increase or decrease the cooking time. Time can be increased/decreased in 1 minute increments, up to 10 minutes. Turning the dial to zero will end cooking.
6. It is possible to refill water tank at any time during cooking, without having to touch Stop/Cancel first.
7. It may be necessary to wipe the excess water in the cavity after **Steam** cooking.



Guidelines

1. During and after cooking with **steam** function, do not open the oven door when your face is very close to the oven. Care must be taken when opening the door as steam may cause injury.
2. Always use oven gloves when removing the food and Square Panacrunch Pan after cooking as the oven and Square Panacrunch Pan will be very hot.
3. After each **steam** operation carefully remove the drip tray from the front of the oven. Gently ease forwards, holding with both hands. After emptying, wash in warm soapy water. To re-position, click back into position on the oven legs. (See page 14).



Caution

The Square Panacrunch Pan and surrounding oven will get very hot. Use oven gloves.

When removing the food or Square Panacrunch Pan, hot water may drip from the oven top.

Steam may billow out when you open the door. If there is steam in the oven, do not reach in with your bare hands! Risk of burns! Use oven gloves.

Take care when removing the drain tank.

Combination grill and microwave



On the base of the oven in your own microwaveable and heatproof dishes, this mode is suitable for cooking lasagne, gratins, meat, potatoes.

To cook successfully by **combination** you should always use a minimum of 200 g food. Small quantities should be cooked by **oven, grill or steam**.

It is not possible to preheat when using this combination mode and food should always be cooked uncovered. The grill will glow on and off during cooking - this is normal. To use grill and microwave in Panacrunch mode see page 35.



Tap Grill to select desired grill power level.

Touch	Power Level	Wattage
Once	Grill 1 (High)	1200 W
Twice	Grill 2 (Medium)	850 W
3 Times	Grill 3 (Low)	650 W



Tap Micro Power to select desired Micro Power level. **High/ medium/ defrost** power is not available.

Touch	Power Level	Wattage
Once	Low	440 W
Twice	Simmer	300 W
3 Times	Warm	100 W

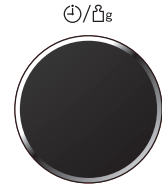

Select the cooking time turning the Time/Weight dial. Maximum cooking time is 90 minutes.



Touch Start.



Note

1. Preheating is not available for **grill + microwave**.
2. High, Medium and Defrost microwave power is not available in combination.
3. You can change the cooking time during cooking if required. Turn the Time/Weight dial to increase or decrease the cooking time. Time can be increased/decreased in 1 minute increments, up to 10 minutes. Turning the dial to zero will end cooking.
4. To turn food just pull the door handle downwards to open, turn the food, return to the oven, close the door and touch Start. The oven will continue to count down the remaining cooking time.

Combination grill and microwave



Directly on the base of the oven in a microwaveable and heatproof dish.

For advice on cooking times refer to cooking charts and recipes in this book. See from page 61. Foods should always be cooked until browned and piping hot.



Containers to use

Do not use plastic microwave containers on combination programs (unless suitable for combination cooking). Dishes must be able to withstand the heat of the top grill - heatproof glass e.g. Pyrex[®] or ceramic are ideal.



Caution

Your dishes and surrounding oven will get very hot. Use oven gloves.



Guideline

Food is always cooked **uncovered**.

Multi-stage cooking

2 or 3 stage cooking

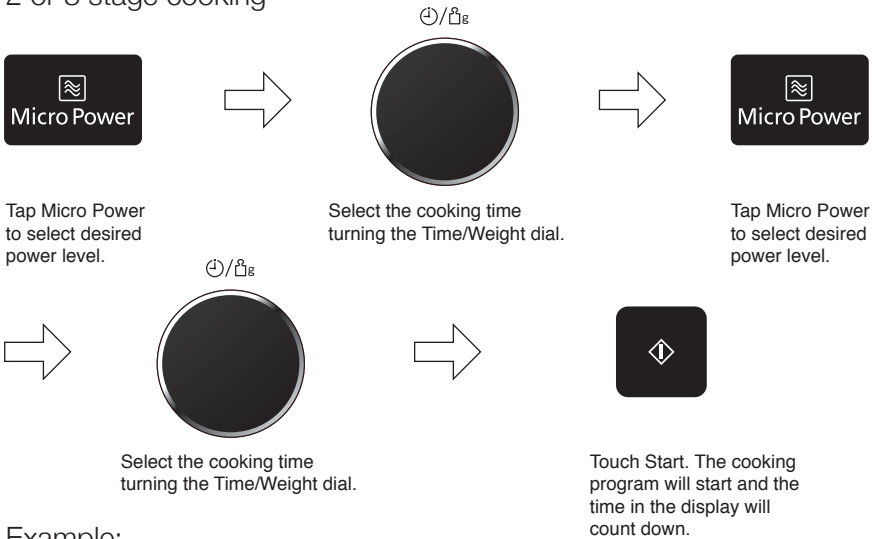

Example:

To **DEFROST (270 W)** for 2 minutes and cook food on **HIGH (1000 W)** power for 3 minutes.

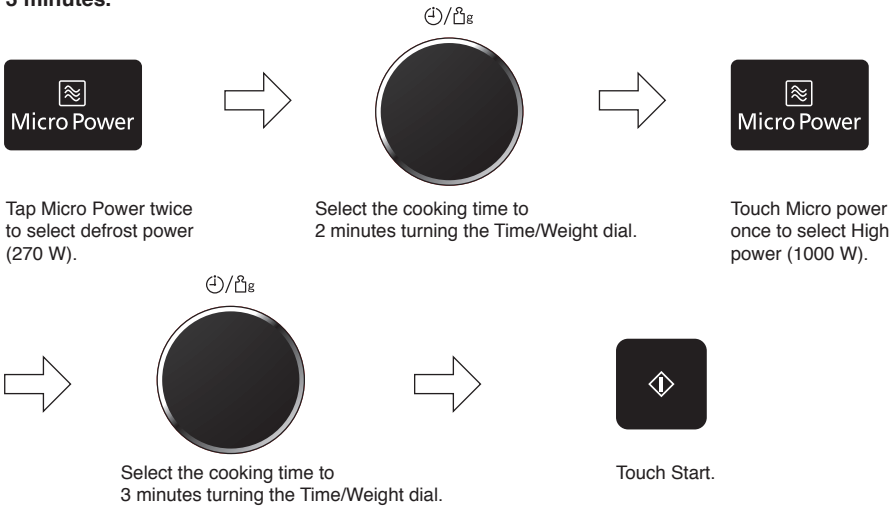

Note

1. For three-stage cooking, enter another cooking program before touching Start.
2. During operation, touching Stop/Cancel once will stop the operation. Touching Start will re-start the programmed operation. Touching Stop/Cancel twice will stop and clear the programmed operation.
3. Whilst not operating, touching Stop/Cancel will clear the selected program.
4. Auto programs cannot be used with multi-stage cooking.
5. **Oven** and **Panacrunch** cannot be used with multi-stage cooking.

Multi-stage cooking

Example:

To **GRILL 3 (low)** for 4 minutes and cook food on **LOW** power (440 W) for 5 minutes.

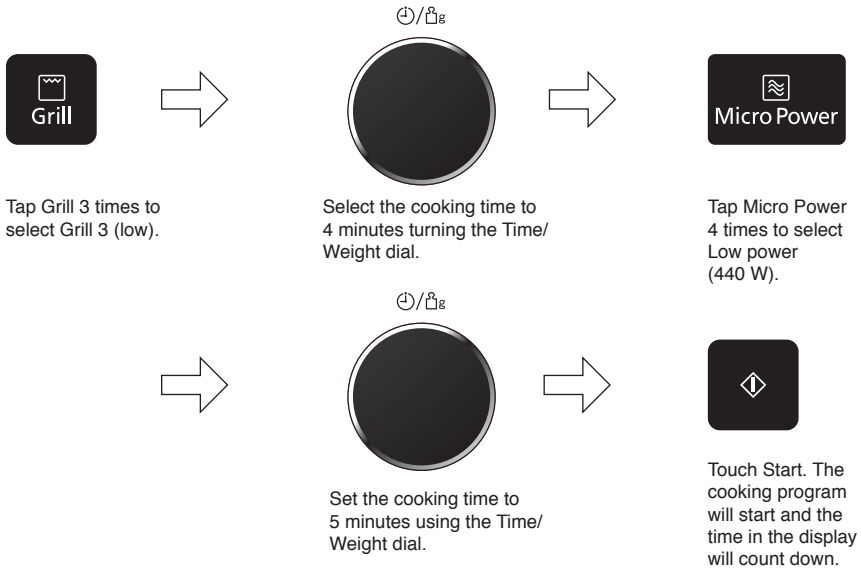

Note

1. For three-stage cooking, enter another cooking program before touching Start.
2. During operation, touching Stop/Cancel once will stop the operation. Touching Start will re-start the programmed operation. Touching Stop/Cancel twice will stop and clear the programmed operation.
3. Whilst not operating, touching Stop/Cancel will clear the selected program.
4. Auto programs cannot be used with multi-stage cooking.
5. Oven and Panacrunch cannot be used with multi-stage cooking.

Using the timer

Delay start cooking

By using the timer, you are able to program delay start cooking.

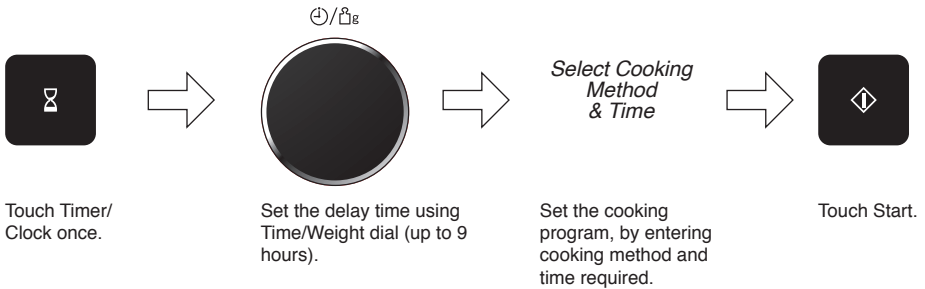

Example:

Delay start: 1 hour

High power (1000 W): 10 mins

Simmer power (300 W): 20 mins

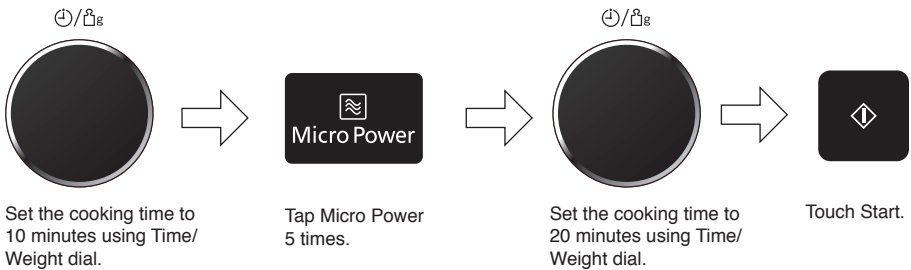
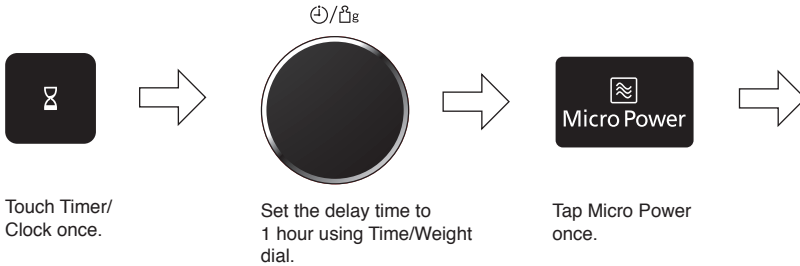

Note

1. Three-stage cooking can be programmed including delay start cooking.
2. If the oven door is opened during the delay time, the time in the display window will continue to count down.
3. If the programmed delay time exceeds one hour, the time will count down in units of minutes. If less than one hour, the time will count down in units of seconds.
4. Delay start cannot be used before an auto program.

Using the timer

To set a standing time:

By using the Timer, you can program Stand Time after cooking is completed or use to program the oven as a minute timer.

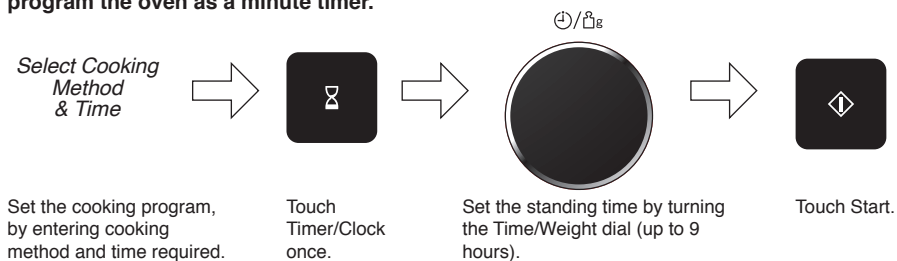

Example:

High power (1000 W): 4 mins

Stand Time: 5 mins

High power (1000 W): 2 mins

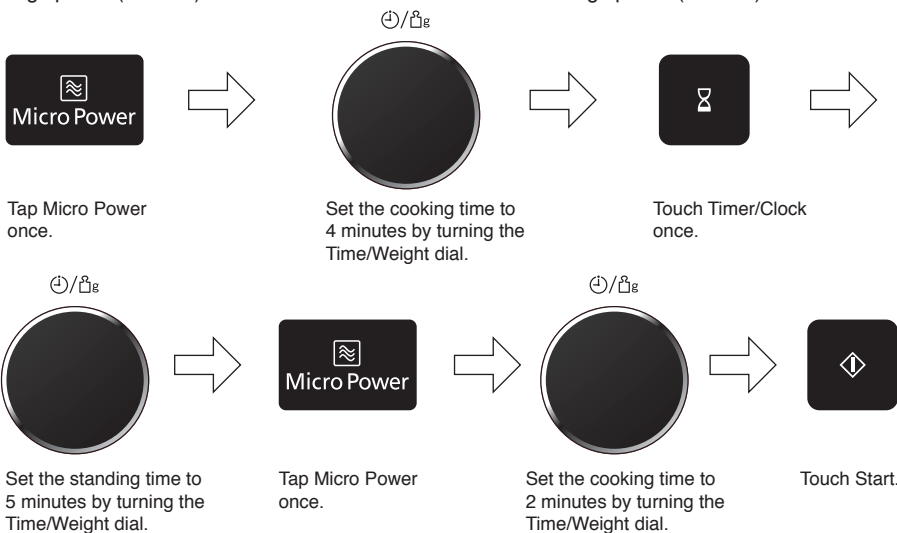

Note

1. Three-stage cooking can be programmed including stand time.
2. If the oven door is opened during the stand time or minute timer, the time in the display window will continue to count down.
3. If the programmed stand time exceeds one hour, the time will count down in units of minutes. If less than one hour, the time will count down in units of seconds.
4. This feature may also be used as a minute timer. In this case touch the Timer/Clock, set time and touch Start.
5. Standing time cannot be used after an auto program.

Chaos defrost



This feature allows you to defrost minced meat, chops, chicken portions, meat joints and bread. Tap Chaos defrost to select the correct defrost category and then enter in the weight of the food in grams (see page 51).

Foods should be placed in a suitable dish, whole chickens and joints of meat should be on an upturned saucer or on a microwave safe plate. Chops, chicken portions and slices of bread should be placed in a single layer. It is not necessary to cover the foods.

The **CHAOS Theory** principle is used in auto weight defrost programs to give you a quick and more even defrost. The CHAOS system uses a random sequence of pulsing microwave energy which speeds up the defrosting process. During the program the oven will beep to remind you to check the food. **It is essential that you turn and stir the food frequently and shield if necessary. On hearing the first beep you should turn and shield (if possible).** On the second beep you should turn the food or break it up.

1st Beep

Turn or Shield



1st Beep

Turn or Shield

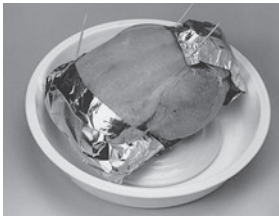

2nd Beep

Turn or break up



Note

1. Check foods during defrosting. Foods vary in their defrosting speed.
2. It is not necessary to cover the food.
3. Always turn or stir the food especially when the oven "beeps". Shield if necessary (see point 5).
4. Minced meat/chops/chicken portions should be broken up or separated as soon as possible and placed in a single layer.
5. Shielding prevents food cooking. It is essential when defrosting chickens and joints of meat. The outside thaws out first, so protect wings/breast/fat with smooth pieces of aluminium foil secured with cocktail sticks.
6. Allow standing time so that the centre of the food thaws out (minimum 1-2 hours for joints of meat and whole chickens).
7. If 'HOT' appears in the display window, the oven temperature is too high from previous use and an auto program can not be set. Cooking mode and time may still be set manually.

Chaos defrost



With this feature you can defrost frozen foods according to the weight. Select the category and set the weight of the food. The weight is programmed in grams. For quick selection, the weight starts from the most commonly used weight for each category.



Tap Chaos defrost.
Once Meat items.
Twice Meat joints.
Three times Bread.

Select the weight by turning the Time/Weight dial. The Time/Weight dial will count up in 10 g steps.

Touch Start.

Program	Weight	Instructions
 1. MEAT ITEMS	100 - 1200 g	To defrost small pieces of meat, chicken portions, chops, steaks, minced meat. Place on a plate or shallow dish. Select program number 1. Enter weight of meat items. Touch Start. Turn at beeps and shield.
 2. MEAT JOINTS	400 - 2000 g	To defrost whole chicken, meat joints. Place on an upturned saucer on a plate. Select program number 2. Enter weight of meat joint. Touch Start. Turn at beeps and shield.
 3. BREAD	100 - 900 g	To defrost rolls, buns, slices of bread and loaves. Place on a plate. Select program number 3. Enter weight of bread. Touch Start. Turn at beeps.

1. Meat items (mince/chops/chicken portions)

Chops and chicken portions should be arranged in a single layer and turned frequently during defrosting. It is necessary for mince to be broken up frequently during defrosting and this is best carried out in a large shallow dish. Standing time 20-30 mins. **Not suitable for sausages**, these can be defrosted manually. Please refer to defrosting chart on pages 31-32.

2. Meat joints/Whole chickens

Whole chickens and meat joints will require shielding during defrosting especially if it is a particularly fatty piece. This is to prevent food starting to cook on the outside edges. Protect wings, breast and fat with smooth pieces of aluminium foil secured with cocktail sticks. **Do not allow the foil to touch the walls of the oven.** Standing time of at least 1-2 hours should be allowed for joints after defrosting.

3. Bread

This program is suitable for small items which are required for immediate use, they may feel warm straight after defrosting. Loaves can also be defrosted on this program but these will require standing time to allow the centre to thaw out. Standing time can be shortened if slices are separated and buns and loaves cut in half. Items should be turned during defrosting. Standing time 10 - 30 minutes. A longer time may be needed for large loaves. **This program is not suitable for cream cakes or desserts** e.g. cheesecake.



Note

- The shape and size of the food will determine the maximum weight the oven can accommodate.
- Allow standing time to ensure the food is completely defrosted.
- If 'HOT' appears in the display window, the oven temperature is too high from previous use and an auto program can not be set. Cooking mode and time may still be set manually.

Auto steam programs



This feature allows you to steam some of your favourite foods by setting the weight only. The oven determines the steam level and the cooking time automatically. Select the category and set the weight of the food. The weight is programmed in grams. For quick selection, the weight starts from the most commonly used weight for each category.



Select desired Auto steam program. The food category appears in the window.

Select the weight by turning the Time/Weight dial. The Time/Weight dial will count up in 10 g steps.

Touch Start. The cooking program will start and the time in the display will count down.

When you select an automatic program, symbols will appear in the display to show the cooking mode that will be used and if the Square Panacrunch Pan is needed. See below to identify the symbols:



Square Panacrunch Pan



Steam











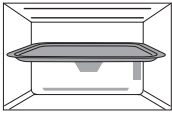

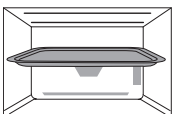

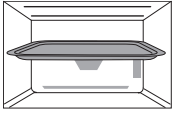
Guidelines for Use

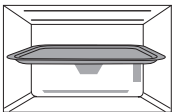
1. The auto steam programs must **only** be used for foods described.
2. Only cook foods within the weight ranges described.
3. Always weigh the food rather than relying on the package weight information.
4. Only use the Square Panacrunch Pan as indicated on page 53.
5. For larger weights on the auto programs chicken breasts and rice, it will be necessary to re-fill the water tank during cooking.
6. Do not cover foods on the auto steam programs.
7. Most foods benefit from a **standing** time after cooking on an auto program, to allow heat to continue conducting to the centre.
8. To allow for some variations that occur in food, check that food is thoroughly cooked and piping hot before serving.
9. The temperature for frozen food is assumed to be -18 °C to -20 °C. The temperature of chilled food is assumed to be +5 °C to +8 °C (refrigerator temperature).
10. If 'HOT' appears in the display window, the oven temperature is too high from previous use and an auto program can not be set. Cooking mode and time may still be set manually.

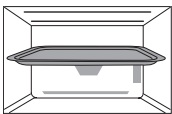
Auto steam programs

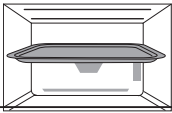

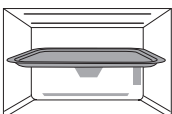
Program	Weight	Accessories	Instructions
 <p>4. FRESH VEGETABLES</p>	200 g - 320 g		To steam fresh vegetables e.g. carrots, broccoli, cauliflower, green beans. Fill water tank. Place prepared vegetables onto Square Panacrunch Pan. Place in the upper shelf position. Select program number 4. Enter the weight of the fresh vegetables. Touch Start.
 <p>5. FROZEN VEGETABLES</p>	200 g - 320 g		To steam frozen vegetables e.g. carrots, broccoli, cauliflower, green beans. Fill water tank. Place vegetables onto Square Panacrunch Pan. Place in the upper shelf position. Select program number 5. Enter the weight of the frozen vegetables. Touch Start.
 <p>6. POTATOES</p>	200 g - 500 g		To steam potatoes. Fill water tank. Peel potatoes and cut into even sized pieces. Place prepared potatoes onto Square Panacrunch Pan. Place in the upper shelf position. Select program number 6. Enter the weight of the potatoes. Touch Start.
 <p>7. CHICKEN BREASTS</p>	200 g - 650 g		To cook fresh chicken breasts. Each chicken breast should weigh between 100-250 g each. Fill water tank. Place chicken onto Square Panacrunch Pan. Place in the upper shelf position. Select program number 7. Enter the weight of the chicken breasts. Touch Start. Check water tank during cooking and re-fill as necessary.
 <p>8. FRESH FISH FILLETS</p>	200 g - 500 g		To cook fresh fish fillets e.g. salmon, cod, haddock, plaice. Fill water tank. Place fresh fish onto Square Panacrunch Pan. Place in the upper shelf position. Select program number 8. Enter the weight of the fresh fish. Touch Start.
 <p>9. FROZEN FISH FILLETS</p>	200 g - 500 g		To cook frozen fish fillets e.g. salmon, cod, haddock. Fill water tank. Place frozen fish onto Square Panacrunch Pan. Place in the upper shelf position. Select program number 9. Enter the weight of the fish. Touch Start.
 <p>10. RICE</p>	100 g - 200 g		For cooking rice for savoury dishes (Thai, Basmati, Jasmine, long grain), not pudding rice. Rinse the rice in cold water. Fill water tank. Place rice in a shallow Pyrex® dish. Add 3 parts cold water to 2 parts rice. Do not cover. Place dish onto Square Panacrunch Pan. Place in the upper shelf position. Select program number 10. Enter the weight of the rice only. Touch Start. Check water level during cooking and re-fill as necessary.

Auto cook programs



This feature allows you to cook some of your favourite foods by setting the weight only. The oven determines the microwave power level and/or combination level and the cooking time automatically. Select the category and set the weight of the food. The weight is programmed in grams. For quick selection, the weight starts from the most commonly used weight for each category.

Example:

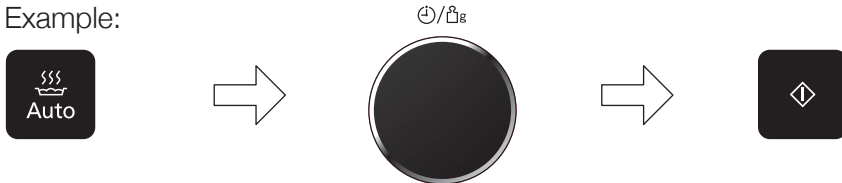

Select the desired Auto Cook Program. The food category appears in the window.

Select the weight by turning the Time/Weight dial. The Time/Weight dial will count up in 10 g steps.

Touch Start. The cooking program will start and the time in the display will count down.

When you select an automatic program, symbols will appear in the display to show the cooking mode that will be used. See below to identify the symbols:



Micro Power



Grill









Guidelines

1. The auto cook programs must **only** be used for foods described.
2. Only cook foods within the weight ranges described.
3. Always weigh the food rather than relying on the package weight information.
4. The temperature for frozen food is assumed to be -18 °C to -20 °C. The temperature of chilled food is assumed to be +5 °C to +8 °C (refrigerator temperature).
5. The Square Panacrunch Pan is not used on the auto cook programs. Dishes are placed directly on the base of the oven.
6. Programs 11-16 are Microwave only. Program 17 uses a combination of Microwave and Grill.
7. Most foods benefit from a **standing** time after cooking on an auto program, to allow heat to continue conducting to the centre.
8. To allow for some variations that occur in food, check that food is thoroughly cooked and piping hot before serving.
9. If 'HOT' appears in the display window, the oven temperature is too high from previous use and an auto program can not be set. Cooking mode and time may still be set manually.

Program	Weight	Instructions
 11. CHILLED MEAL	200 g - 1000 g	To reheat a fresh pre-cooked meal. Foods should be at refrigerator temperature approx. + 5 °C. Reheat in container as purchased. Pierce covering film with a sharp knife once in the centre and four times around the edge. If transferring food to dish, cover with pierced cling film. Place container on base of oven. Select program number 11. Enter weight of meal and touch Start. Stir at beeps. Stir again at end of program and allow a few minutes standing time. Large pieces of meat/fish in a thin sauce may require longer cooking. This program is not suitable for starchy food such as rice, noodles or potatoes. Meals in irregular bowl shaped containers may need longer cooking.

Auto cook programs



Program	Weight	Instructions
 <p>12. FROZEN MEAL</p>	200 g - 1000 g	To reheat a frozen pre-cooked meal. All foods must be pre-cooked and frozen (-18 °C). Reheat in container as purchased. Pierce covering film with a sharp knife once in the centre and four times around the edge. If transferring food to dish, cover with pierced cling film. Place container on base of oven. Select program number 12. Enter the weight of the frozen meal. Touch Start. Stir at beeps and cut any blocks into pieces. Stir again at end of program and allow a few minutes standing time. Large pieces of meat/fish in a thin sauce may require longer cooking. This program is not suitable for starchy food such as rice, noodles or potatoes. Meals in irregular bowl shaped containers may need longer cooking.
 <p>13. FRESH VEGETABLES</p>	200 g - 1000 g	To cook fresh vegetables e.g. carrots, broccoli, cauliflower, green beans. Place prepared vegetables into a suitable sized Pyrex® container. Sprinkle with 15 ml (1 tbsp) water per 100 g vegetables. Cover with pierced cling film or a lid. Place food in container on base of oven. Select auto cook program 13. Enter the weight of the fresh vegetables. Touch Start. Stir at beeps.
 <p>14. FROZEN VEGETABLES</p>	200 g - 1000 g	To cook frozen vegetables e.g. carrots, broccoli, cauliflower, green beans. Place frozen vegetables in a suitable sized Pyrex® container. Sprinkle with 15-45 ml (1-3 tbsp) water. Cover with pierced cling film or a lid. Place container on base of oven. Select auto cook program 14. Enter the weight of the frozen vegetables. Touch Start. Stir at beeps.
 <p>15. FRESH FISH FILLETS</p>	200 g - 800 g	To cook fresh fish fillets e.g. salmon, cod, plaice, haddock. Place in a shallow Pyrex® container. Shield the thinner portions. Ensure the fish is not overlapping. Fold under thin edges. Add 15-45 ml (1-3 tbsp) of water. Cover with pierced cling film or a lid. Place container on base of oven. Select auto cook program 15. Enter the weight of the fresh fish. Touch Start. Cook skin side down and turn at beeps. Allow a few minutes standing time.
 <p>16. BOILED POTATOES</p>	200 g - 1000 g	To cook potatoes without skin. Peel potatoes and cut into even sized pieces. Place prepared potatoes in a Pyrex® dish. Add 15 ml (1 tbsp) water per 100 g of potatoes. Cover with pierced cling film or a lid. Select auto cook program 16. Enter the weight of the potatoes. Touch Start. Stir at beeps.
 +  <p>17. POTATO GRATIN</p>	-	See recipe below. Place prepared potato gratin on base of oven. Select auto cook program 17. Touch Start (it is not necessary to enter the weight of the food). Allow to stand for 5 minutes after cooking.

Gratin dauphinois

ingredients

Serves 4

700 g peeled potatoes,
1 garlic clove,
70 g emmental, grated,
salt and pepper,
200 ml single cream,
200 ml milk

1. Cut the potatoes into thin slices. Peel and chop the garlic.
2. Arrange the potato slices in dish. Scatter over the garlic, half the cheese, salt and pepper.
3. Pour over the cream and milk. Cover with the rest of the grated cheese. Place on base of oven.
4. Select auto cook program 17. Touch Start. Allow to stand for 5 minutes after cooking.

Dish: 1 x 25 cm shallow Pyrex® dish
Accessory: none

Panacrunch programs



This feature allows you to cook some of your favourite foods by setting the weight only. The oven determines the microwave power level and/or combination level and the cooking time automatically. Select the category and set the weight of the food. The weight is programmed in grams. For quick selection, the weight starts from the most commonly used weight for each category.

example

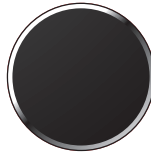

Select the desired Panacrunch program. The food category appears in the window.

Select the weight by turning the Time/Weight dial. The Time/Weight dial will count up in 10 g steps.

Touch Start. The cooking program will start and the time in the display will count down.

When you select an automatic program, symbols will appear in the display to show the cooking mode that will be used and if the Square Panacrunch Pan is needed. See below to identify the symbols:



Micro Power



Grill



Square Panacrunch Pan





Steam







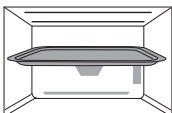



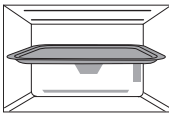

Guidelines

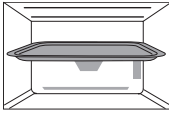
1. The Panacrunch programs must **only** be used for foods described.
2. Only cook foods within the weight ranges described.
3. Always weigh the food rather than relying on the package weight information.
4. The temperature for frozen food is assumed to be -18 °C to -20 °C. The temperature of chilled food is assumed to be +5 °C to +8 °C (refrigerator temperature).
5. Programs 18-20 use a combination Grill and Microwave. Programs 21-23 use a combination Steam and Grill.
6. Only use the Square Panacrunch Pan as indicated on pages 56-57.
7. Most foods benefit from a **standing** time after cooking on an auto program, to allow heat to continue conducting to the centre.
8. To allow for some variations that occur in food, check that food is thoroughly cooked and piping hot before serving.
9. If 'HOT' appears in the display window, the oven temperature is too high from previous use and an auto program can not be set. Cooking mode and time may still be set manually.

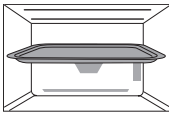
Program	Weight	Accessories	Instructions
 +  18. FROZEN POTATO PRODUCTS	100 g - 500 g		To cook frozen oven chips and potato products, e.g. hash browns, croquettes, etc. Spread potato products out on Square Panacrunch Pan and place in upper shelf position. Select program number 18. Enter the weight of the frozen potato products. Touch Start. For best results cook in a single layer. Note: Potato products vary considerably. We suggest checking a few minutes before the end of cooking to assess level of browning.

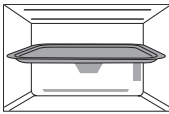
Panacrunch programs

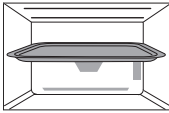
Program	Weight	Accessories	Instructions
 +  19. CHILLED PIZZA	100 g - 400 g		For reheating and browning chilled , purchased pizza. Remove all packaging and place on Square Panacrunch Pan in upper shelf position. Select program number 19. Enter the weight of the chilled pizza and touch Start. This program is not suitable for deep pan pizzas, stuffed crust pizzas or very thin pizzas.
 +  20. FROZEN PIZZA	300 g - 500 g		For reheating and browning frozen , purchased pizza. Remove all packaging and place on Square Panacrunch Pan in upper shelf position. Select program number 20. Enter the weight of the frozen pizza and touch Start. This program is not suitable for deep pan pizzas, stuffed crust pizzas or very thin pizzas.
 +  21. FRESH FISH FILLETS	300 g - 750 g		To cook fresh fish fillets e.g. salmon, cod, haddock weighing a maximum 180 g each with steam + grill. Fill water tank. Place fresh fish, skin side up, onto Square Panacrunch Pan. Brush skin with oil. Place in the upper shelf position. Select program number 21. Enter the weight of the fresh fish. Touch Start.
 +  22. FRESH WHOLE FISH	200 g - 650 g		To cook fresh whole fish e.g trout, sea bream, mackerel, sea bass, sardines weighing between 100 g - 400 g each with steam + grill. Fill water tank. Place whole fish directly onto Square Panacrunch Pan. Before cooking non-oily fish (sea bass, trout), brush with oil. Place in the upper shelf position. Select program number 22. Enter the weight of the whole fresh fish. Touch Start.
 +  23. CHICKEN PIECES	200 g - 650 g		To cook fresh chicken pieces e.g. chicken drumsticks and chicken thighs with steam + grill. Each chicken piece should weigh between 100 g - 180 g. Pierce the chicken skin a few times before cooking. Fill water tank. Place chicken pieces onto Square Panacrunch Pan. Place in the upper shelf position. Select program number 23. Enter the weight of the chicken pieces. Touch Start. Check water tank during cooking and re-fill as necessary.

System cleaning programs

F1. DRAIN WATER

Water is pumped through the system to clean the pipes. The water is drained into the drip tray.

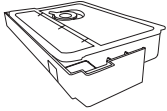

Add 100 g of water to the water tank. Ensure drip tray is empty.



Tap System cleaning once until F1 Drain water program appears in the display.



Touch Start. Empty the drip tray after the program has finished.



Note

1. Only run this program with 100 g of water in the tank.
2. Do not remove the drip tray during the drain water program.
3. Empty the drip tray and rinse with running water after the program has finished.



Caution

4. If the drain water program is used directly after a steam cooking program, hot water may be drained into the drip tray.

F2. SYSTEM CLEANING

The first stage of this program cleans the system with a citric acid solution. The second stage runs water through the system to rinse the pipes.

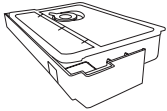

Make a solution of 16 g citric acid and 200 g of water, add the solution to the water tank. Ensure drip tray is empty.



Tap System cleaning twice until F2 SYSTEM CLEANING program appears in the display.



Touch Start. The program will run for approx. 29 minutes.

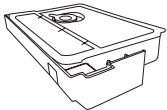

After the program has paused, empty the drip tray and fill the water tank with water (to max level).



Touch Start. The program will run for approx. 1 minute. Empty the drip tray after the program has finished.



Note

1.  symbol appears in the display when running the DRAIN WATER and SYSTEM CLEANING program.
2. If the system cleaning program is not used regularly, the pipe will get blocked and the steaming performance will be less effective.
3. Do not remove the drip tray during the drain program.
4. Empty the drip tray and rinse with running tap water after the program has finished.

Cleaning the water tank

Clean with a soft sponge in water.

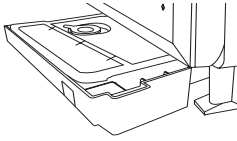

Remove the water tank and clean the compartment where the water tank is inserted.



Open the water supply cap, remove the lid and pipe cap and clean.

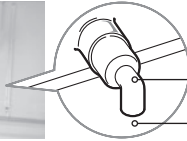
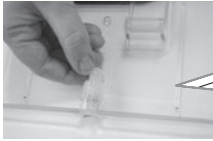

Pipe Cap

Ensure it faces downwards

If the pipe cap is difficult to remove, wiggle from side to side. When re-fitting, make sure that the pipe faces down (see diagram).

The front of the tank can also be removed for cleaning.

Removing the front cover



1. Lightly twist the cover until the far side unclips.
2. Continue to twist until the near side unclips.

Re-fitting the front cover



1. Align the slots on the cover with the holes on the tank.
2. Insert and push down until it clicks.



Note

1. Clean the water tank at least once a week to prevent build up of limescale.
2. Do not use a dishwasher to clean the water tank or parts of the water tank.

Cooking and reheating guidelines

Most foods reheat very quickly in your oven by HIGH power. Meals can be brought back to serving temperature in just minutes and will taste freshly cooked. Always check food is piping hot and return to oven if necessary.

As a general rule, always cover wet foods, e.g. soups, casseroles and plated meals.

Do not cover dry foods e.g. bread rolls, mince pies, sausage rolls etc.

The charts on pages 61-75 show you the best way to cook or reheat your favourite foods. The best method depends on the type of food you are cooking or reheating.

Remember to stir or turn food wherever possible during cooking or reheating. This ensures even cooking or reheating on the outside and in the centre.

When is food reheated?

Food that has been reheated or cooked should be served "piping hot" i.e. steam should be visibly emitted from all parts. As long as good hygiene practices have been followed during the preparation and storage of the food, then cooking or reheating presents no safety risks.

Foods that cannot be stirred should be cut with a knife to test that they are adequately heated throughout. Even if a manufacturer's instructions or the times in the cookbook have been followed, it is still important to check the food is heated thoroughly. If in doubt, always return to the oven for further reheating. If you cannot find the equivalent food in the chart then choose a similar type and size listed and adjust the cooking time if necessary.

Plated meals

Everyone's appetite varies and reheat times depend on meal contents. Dense items e.g. mashed potato, should be spread out well. If a lot of gravy is added, extra time may be required. Place denser items to the outside of the plate.

An average plated meal will take 4-7 minutes on HIGH power to reheat. Do not stack meals.

Canned foods

Remove foods from can and place in a suitable dish before heating. Stir food halfway through cooking and again at the end of heating.

Soups

Use a bowl and stir before heating and at least once during reheating and again at the end.

Casseroles

Stir halfway through and again at the end of heating.



Caution - Mince pies

Remember even if the pastry is cold to the touch, the filling will be piping hot and will warm the pastry through. Take care not to overheat otherwise burning can occur due to the high fat and sugar content of the filling. Check the temperature of the filling before consuming to avoid burning your mouth.



Caution - Christmas puddings and liquids

Take great care when reheating these items.

Do not leave unattended.
Do not add extra alcohol.



Caution - Babies' bottles

Milk or formula **must** be shaken thoroughly before heating and again at the end and tested carefully before feeding a baby. Liquid at the top of the bottle will be much hotter than at the bottom. The bottle must be shaken thoroughly and tested before use.



Note

We do not recommend that you use your microwave to sterilise babies' bottles. If you have a special microwave steriliser we urge extreme caution, due to the low quantity of water involved. It is vital to follow the manufacturers instructions implicitly.

Reheating charts

The times given in the charts below are a guideline only, and will vary depending on **STARTING** temperature, dish size and quantity. Pastry or bread items reheated by microwave will be soft not crisp.

Heating category

Your oven is Heating Category E and this is displayed on the rear of your oven. The information on this label will assist you in using new instructions on food packs to enable you to program the best heating time in your oven.

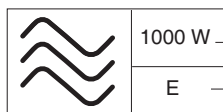

Microwave symbol

The IEC (60705) power output (watts)

The heating category for small packs of food

Food	Weight/ Quantity	Power Level	Time to Select (approx)	Instructions/Guidelines
Babies bottles – CAUTION				
After heating by Microwave, liquid at the top of a bottle will be much hotter than at the bottom of the bottle and must be shaken thoroughly before checking the temperature. When testing the temperature of the milk, squirt a little onto your inner wrist. The milk droplets on your skin should feel warm, not hot. For 250 ml of milk from fridge temperature, remove top and teat. Heat on HIGH Power for 40 secs. CHECK CAREFULLY For 100 ml of milk from fridge temperature, remove top and teat. Heat on HIGH Power for 20 secs. CHECK CAREFULLY				
Bread – Precooked – Fresh – N.B. Breads reheated by Microwave will have a soft base.				
Croissants / brioche	1	HIGH Micro	10 secs	Place in Pyrex® dish on base. Do not cover.
	4	HIGH Micro	30 secs	
	any	GRILL 1 + LOW Micro	4 mins	Place on Square Panacrunch Pan in upper shelf position.
Canned pasta				
Ravioli	400 g	HIGH Micro	2 mins 30 secs	Place in a heatproof bowl and cover. Place on base and stir halfway.
Macaroni cheese			2 mins 30 secs	
Spaghetti			2 mins 30 secs	
Canned puddings				
Rice pudding	213 g	HIGH Micro	1 min	Place in a heatproof bowl and cover. Place on base and stir halfway.
	400 g		2 mins	
Custard - small jug	190 g	HIGH Micro	1 min 30 secs	Place in a heatproof bowl and cover. Place on base and stir halfway.
	400 g		2 mins	



Points for checking

Always check that food is piping hot after reheating in the microwave. If unsure return to oven. Foods will still require a **stand time**, especially if they cannot be stirred. The denser the food the longer the stand time.

Reheating charts

Food	Weight/ Quantity	Power Level	Time to Select (approx)	Instructions/Guidelines
Canned soups				
Condensed	295 g	HIGH Micro	3-4 mins	Place in a heatproof bowl and stir in one can of water. Cover and place on base stirring halfway.
Healthy option	415 g		3 mins	
Luxury/vegetable/ broth	400/415 g		3 mins	Place in a heatproof bowl and cover. Place on base and stir halfway.
Creamed	400 g		3 mins	
Chilled soups				
1 Portion	250 ml	HIGH Micro	2 mins- 2 mins 30 secs	Place in a heatproof bowl and cover. Place on base and stir halfway.
2 Portion	500 ml		4 mins- 4 mins 30 secs	
Canned vegetables				
Baked beans	200 g	HIGH Micro	1 min 30 secs	Place in a heatproof bowl and cover. Place on base and stir halfway.
	415 g		2 mins- 2 mins 30 secs	
Baked beans with sausages	400 g		2 mins 30 secs- 3 mins	
Broad beans	300 g		2 mins	
Butter beans	210 g		1 min 30 secs- 2 mins	
Carrots, sliced	300 g		4 mins	
Green beans	400 g		5 mins	
Mushrooms	290 g	HIGH Micro	2 mins- 2 mins 30 secs	
Peas, mushy	300 g		2 mins- 2 mins 30 secs	
Peas, petit pois	400 g	HIGH Micro	2 mins- 2 mins 30 secs	
Peas, garden	300 g		2 mins	
Peas, marrowfat	300 g	HIGH Micro	2 mins- 2 mins 30 secs	
Sweetcorn	200 g		1 min- 1 min 30 secs	
	330 g	2 mins- 2 mins 30 secs		
Tomatoes	400 g	HIGH Micro	2 mins	
Plated meal - chilled				
Small - child portion	1	HIGH Micro	4-5 mins	Cover and place on base.
Large - adult portion			7 mins	



Points for checking

Always check that food is piping hot after reheating in the microwave. If unsure return to oven. Foods will still require a **stand time**, especially if they cannot be stirred. The denser the food the longer the stand time.

Reheating charts

Food	Weight/ Quantity	Power Level	Time to Select (approx)	Instructions/Guidelines
Drinks				
1 Mug cold milk	235 ml	HIGH Micro	1 min 30 secs	Place in a heatproof container on base. Stir halfway and after reheating.
1 Jug cold milk	568 ml (1 pint)		4 mins	
1 Mug cold coffee/tea	235 ml		1 min 20 secs	
1 Mug cold milky coffee			1 min 20 secs	
Savoury pastry products - pre-cooked				
Pastries reheated by microwave will have a soft base				
Pasties/slices	150 g	HIGH Micro	1 min 30 secs	Place on a plate on base.
	150 g	GRILL 1 + WARM Micro	10-11 mins	Place on Square Panacrunch Pan in lower shelf position.
	300 g (2)	GRILL 1 + WARM Micro	15 mins	
Meat pies	150 g	HIGH Micro	1 min 30 secs- 2 mins	Place on a plate on base.
	150 g	GRILL 2 + LOW Micro	6-7 mins	Remove product from foil container and place on Square Panacrunch Pan in lower shelf position.
	300 g (2)		7-8 mins	
	250 g	GRILL 2 + SIMMER Micro	7-8 mins	
	550 g		15 mins	
Quiche	150 g	GRILL 2 + SIMMER Micro	7-8 mins	Remove product from foil container and place on Square Panacrunch Pan in lower shelf position.
	400 g	GRILL 2 + SIMMER Micro	10-11 mins	
Sausage roll x 1	150 g	HIGH Micro	1 min 10 secs	Place in Pyrex® dish on base of oven.
		GRILL 1 + WARM Micro	8-10 mins	Place on Square Panacrunch Pan in lower shelf position.
Sausage roll Snack size x 5	300 g	GRILL 1 + WARM Micro	7-8 mins	Place on Square Panacrunch Pan in lower shelf position.



Points for checking

Always check that food is piping hot after reheating in the microwave. If unsure return to oven. Foods will still require a **stand time**, especially if they cannot be stirred. The denser the food the longer the stand time.

Reheating charts

Food	Weight/ Quantity	Power Level	Time to Select (approx)	Instructions/Guidelines
Puddings and desserts - where microwave only is involved transfer food from foil container to a similar sized heatproof dish				
Chilled custard	500 g	HIGH Micro	3 mins	Place in large jug. Cover and place on base and stir halfway.
Chilled rice pudding	180 g	HIGH Micro	1 min	Place on base.
	500 g	HIGH Micro	2 mins	Place in a heatproof dish. Cover and place on base. Stir halfway.
Chilled Fruit crumble	550 g	GRILL 1 + LOW Micro	12 mins	Place in a heatproof dish on base.
Fruit pie - large	550 g	220 °C	15 mins	Remove product from foil container and place on Square Panacrunch Pan in lower shelf position.
- Individual	x 1	HIGH Micro	10 secs	Remove foil. Place in Pyrex® dish on base.
Mince pies	x 2	HIGH Micro	10- 20 secs	Remove foil. Place on micro-safe plate on base.
Mini pancakes	250 g x 6	STEAM 1	2 mins	Place on Square Panacrunch Pan in lower shelf position.
Sponge pudding	110 g x 1	STEAM 1 + LOW Micro	2 mins	Pierce film lid and place on base.
	220 g x 2		3 mins 30 secs	
Christmas pudding - Do not leave unattended as overheating can cause the food to ignite.				
Small	100 g	STEAM 1 + LOW Micro	1 min	Pierce film lid and place on plate on base.
Medium	227 g	STEAM 1 + LOW Micro	2 mins	
Large	454 g	STEAM 1 + LOW Micro	5 mins	
Ready meals - chilled. Transfer food from foil container to a similar sized heatproof dish. Healthy eating options will only slightly brown on combination because of the lower fat content.				
Cauliflower cheese	400 g	GRILL 1 + LOW Micro	7 mins	Place in heatproof dish on base.



Points for checking

Always check that food is piping hot after reheating in the microwave. If unsure return to oven. Foods will still require a **stand time**, especially if they cannot be stirred. The denser the food the longer the stand time.

Reheating charts

Food	Weight/ Quantity	Power Level	Time to Select (approx)	Instructions/Guidelines
Cottage/shepherds pie	450 g	HIGH Micro or GRILL 1 + LOW Micro	4 mins	Place on base.
			10 mins	Place on base.
	800 g	GRILL 1 + LOW Micro	15 mins	Place on base.
Fish/veg bake	450 g	HIGH Micro or GRILL 1 + LOW Micro	5 mins	Place on base.
			12 mins	Place on base.
	900 g	GRILL 1 + LOW Micro	17 mins	Place on base.
Onion bhajis/samosas	200 g	GRILL 1 + LOW Micro	5 mins	Place on Square Panacrunch Pan in upper shelf position. Turn halfway.
Lasagne	450 g	HIGH Micro or GRILL 1 + LOW Micro	6 mins	Place on base.
			8 mins	Place on base.
	800 g	GRILL 1 + LOW Micro	16 mins	Place on base.
Macaroni cheese	450 g	GRILL 1 + LOW Micro	8 mins	Place on base.



Points for checking

Always check that food is piping hot after reheating in the microwave. If unsure return to oven. Foods will still require a **stand time**, especially if they cannot be stirred. The denser the food the longer the stand time.

Reheating charts

Food	Weight/ Quantity	Power Level	Time to Select (approx)	Instructions/Guidelines
Ready meals - Chilled.				
Transfer food from foil container to a similar sized heatproof dish. Healthy eating options will only slightly brown on combination because of the lower fat content.				
Chilled mashed potato	500 g	HIGH Micro	4-5 mins	Pierce lid and place on base. Stir halfway.
Carrot and swede mash	500 g	HIGH Micro	4-5 mins	Pierce lid and place on base. Stir halfway
Spring rolls x 4	240 g	GRILL 2 + WARM Micro then on GRILL 1	8-9 mins then 2 mins	Place on Square Panacrunch Pan in upper shelf position.
Ready meals - Frozen.				
Transfer food from foil container to a similar sized heatproof dish. Remove any covering/film lid.				
Cauliflower cheese	400 g	GRILL 2 + LOW Micro	25 mins	Place on base.
Cottage/fish/shepherds pie	400 g	HIGH Micro or GRILL 2 + LOW Micro	12 mins 25 mins	Place on base. Place on base.
Lasagne/cannelloni	400 g	HIGH Micro or GRILL 2 + LOW Micro	10 mins 20 mins	Place on base. Place on base.
Macaroni cheese	400 g	HIGH Micro or GRILL 2 + LOW Micro	10-12 mins 18 mins	Place on base. Place on base.
Quorn®				
Burgers	180 g (2)	STEAM 1 + GRILL 1	10 mins	Place on Square Panacrunch Pan in upper shelf position. Turn halfway
Escalopes	240 g (2)	GRILL 1 + WARM Micro	6-7 mins	Place on Square Panacrunch Pan in upper shelf position.



Points for checking

Always check that food is piping hot after reheating in the microwave. If unsure return to oven. Foods will still require a **stand time**, especially if they cannot be stirred. The denser the food the longer the stand time.

Cooking charts

Food	Weight/ Quantity	Power Level	Time to Select (approx)	Instructions/Guidelines
Bread				
Part-baked rolls	300 g (6)	GRILL 2 + WARM Micro	10-12 mins	Place on Square Panacrunch Pan in lower shelf position.
Part-baked garlic baguette/ciabatta	170 g	GRILL 2 + WARM Micro	9-10 mins	Place on Square Panacrunch Pan in lower shelf position.
Garlic doughballs x 12	165 g	GRILL 2 + WARM Micro	10 mins	Place on Square Panacrunch Pan in lower shelf position.
Bacon and pork - from raw - Caution: Hot fat! Remove accessories with care.				
Bacon rashers	300 g (8)	GRILL 1	8 mins	Place on Square Panacrunch Pan in upper shelf position.
Gammon steaks x 2	500 g	GRILL 1	10-15 mins	Place on Square Panacrunch Pan in upper shelf position.
Pork joint		220 °C Followed by 190 °C	for 30 mins then 60 mins per 500 g Max weight 1.5 kg	Preheat oven. Place joint on Square Panacrunch Pan in lower shelf position. Leave for 10 mins after cooking and before carving.
Pork loin steaks	500 g (5)	GRILL 1	18-20 mins	Place on Square Panacrunch Pan in upper shelf position. Turn halfway.
Gammon joint	800 g	180 °C	30 mins per 500 g plus 30 mins extra	Preheat oven. Place joint on Square Panacrunch Pan in lower shelf position.
Beans and pulses - should be pre-soaked in cold water overnight (boiling water split yellow peas) except lentils which do not need to be pre-soaked.				
Black eyed peas	250 g	HIGH Micro then SIMMER Micro	10 mins then 40 mins	Use 600 ml (1 pt) boiling water in a large bowl. Cover. Place on base.
Chick peas	250 g	HIGH Micro then SIMMER Micro	10 mins then 40 mins	Use 600 ml (1 pt) boiling water in a large bowl. Cover. Place on base.
Lentils	250 g	HIGH Micro	12 mins	Use 600 ml (1 pt) boiling water in a large bowl. Cover. Place on base.



Points for checking

Always check that food is piping hot after reheating in the microwave. If unsure return to oven. Foods will still require a **stand time**, especially if they cannot be stirred. The denser the food the longer the stand time.

Cooking charts

Food	Weight/ Quantity	Power Level	Time to Select (approx)	Instructions/Guidelines
Beans and pulses - should be pre-soaked in cold water overnight (boiling water split yellow peas) except lentils which do not need to be pre-soaked.				
Red kidney beans	250 g	HIGH Micro then SIMMER Micro	15 mins then 40 mins	Use 600 ml (1 pt) boiling water in a large bowl. Cover. Must boil for at least 12 mins to destroy toxic enzymes. Place on base.
Split yellow peas	250 g	HIGH Micro then SIMMER Micro	10 mins then 40 mins	Use 600 ml (1 pt) boiling water in a large bowl. Cover. Place on base.
Beef - Caution: Hot fat! Remove dish with care. Recommended temperatures for beef are: Rare 60 °C; medium 70 °C; well done 80 °C.				
Beef burgers (fresh)	227 g (2)	GRILL 1	15 mins	Place on Square Panacrunch pan in upper shelf position. Turn halfway.
Beef burgers (frozen raw)	227 g (4)	GRILL 1	15 mins	Place on Square Panacrunch Pan in upper shelf position. Turn halfway.
Joint		220 °C	20 mins per 450 g/1 lb Rare: 20 mins Medium: 30 mins Well done: 40-50 mins	Preheat oven. Place on Square Panacrunch Pan in lower shelf position. Turn halfway.
Rump/ sirloin	250 g	GRILL 1	Medium: 14 mins Well done: 18 mins	Place on Square Panacrunch Pan in upper shelf position. Turn halfway.
Stewing steak	450-675 g	160 °C	1 hour - 1 hour 30 mins	Place in casserole dish with lid. Add stock and vegetables. Cover, place Square Panacrunch Pan in lower shelf position. Stir halfway.



Points for checking

Always check that food is piping hot after reheating in the microwave. If unsure return to oven. Foods will still require a **stand time**, especially if they cannot be stirred. The denser the food the longer the stand time.

Cooking charts

Food	Weight/ Quantity	Power Level	Time to Select (approx)	Instructions/Guidelines
Chicken from raw - Caution: Hot fat! Remove accessory with care.				
Breasts, boneless and skinless	250 g (2)	STEAM 1	30 mins	Place on Square Panacrunch Pan in upper shelf position.
Breaded chicken	350 g	GRILL 1 + LOW Micro	12 mins	Place on Square Panacrunch Pan in lower shelf position.
Chicken legs	1.0 kg	GRILL 1	30 mins	Place on Square Panacrunch Pan in lower shelf position. Turn halfway.
Drumsticks/thighs	600 g (5)	GRILL 1	30 mins	Place on Square Panacrunch Pan in upper shelf position. Turn halfway.
Kiev (fresh)	260 g (2)	GRILL 1 + SIMMER Micro	10 mins	Place on Square Panacrunch Pan in lower shelf position.
Whole		190 °C	30 mins per 450 g	Preheat the oven. Place chicken on Square Panacrunch Pan in lower shelf position.
Eggs - Poached.				
1 Egg	45 ml water	HIGH Micro then MEDIUM Micro	1 min 10 secs 60 secs	<ul style="list-style-type: none"> - Place water in a shallow dish and heat for 1st cooking time on base of the oven. - Add egg (size 3). - Pierce yolk and white. - Cover with pierced cling film. - Cook for 2nd cooking time. - Then leave to stand for 1 min.
2 Egg	90 ml water	HIGH Micro then MEDIUM Micro	1 min 40 secs 1 min 30 secs	
4 Egg	180 ml water	HIGH Micro then MEDIUM Micro	3 mins 3 mins	



Points for checking

Always check that food is piping hot after reheating in the microwave. If unsure return to oven. Foods will still require a **stand time**, especially if they cannot be stirred. The denser the food the longer the stand time.

Cooking charts

Food	Weight/ Quantity	Power Level	Time to Select (approx)	Instructions/Guidelines
Eggs - Scrambled. Use microwave safe bowl.				
1 Egg		HIGH Micro	30 secs	- Add 1 tbsp of milk for each egg used. - Beat eggs, milk and knob of butter together. - Place bowl on base. - Cook for 1st cooking time then stir. - Cook for 2nd cooking time stirring halfway then stand for 1 min.
2 Eggs		HIGH Micro	30 secs 1 min	
4 Eggs		HIGH Micro	1 min	
			1 min 30 secs 1 min 30 secs	
Fish - fresh from raw.				
Lightly dusted fillets	265 g (2)	GRILL 2 + LOW Micro	8 mins	Place on Square Panacrunch Pan in upper shelf position.
Breaded Fillets	350 g (2)	GRILL 2 + LOW Micro	10 mins	Place on Square Panacrunch Pan in upper shelf position.
Cakes	270 g (2)	GRILL 2 + LOW Micro	10 mins	Place on Square Panacrunch Pan in upper shelf position.
Fillets	300 g	MEDIUM Micro	7 mins	Place in Pyrex® dish. Add 1 tbsp (15 ml) water. Cover and place on base of oven.
	700 g	MEDIUM Micro	9 mins	
Steaks	300 g (2)	GRILL 2 + STEAM 1	15 mins	Place on Square Panacrunch Pan in lower shelf position.
Whole x 1	225 g/300 g	HIGH Micro	4 mins	Place in Pyrex® dish and pierce skin. Add 30 ml of liquid. Cover and place on base of oven.
Whole x 2	500-600 g	GRILL 2 + STEAM 1	25 mins	Place on Square Panacrunch Pan in upper shelf position.



Points for checking

Always check that food is piping hot after reheating in the microwave. If unsure return to oven. Foods will still require a **stand time**, especially if they cannot be stirred. The denser the food the longer the stand time.

Cooking charts

Food	Weight/ Quantity	Power Level	Time to Select (approx)	Instructions/Guidelines
Fish - frozen from raw.				
Breaded fillets	200 g (2)	GRILL 2 + LOW Micro	10 mins	Place on Square Panacrunch Pan in lower shelf position. Turn halfway.
Cakes	270 g (2)	GRILL 2 + WARM Micro	14 mins	
Fish fingers	110 g (4) 230 g (8)	GRILL 2 + SIMMER Micro	6-8 mins 8-10 mins	Place on Square Panacrunch Pan in upper shelf position.
Fillets	300 g	STEAM 1	10-12 mins	Place on Square Panacrunch Pan in upper shelf position.
Scampi	280 g	GRILL 2 + LOW Micro	8 mins	Place on Square Panacrunch Pan in upper shelf position.
Boil in the bag	150 g	HIGH Micro	5 mins	Place bag sauce side down on a heatproof plate on the base of oven. Pierce top. Shake bag halfway through.
Fruit - Peel, slice, chop into even sized pieces. Place in shallow heatproof dish on base of oven.				
Baked apple-cored	1	STEAM 1 + LOW Micro	8 mins	On a plate on base of oven.
Apples - stewed	500 g		10 mins	Place on base of oven.
Apricots-stewed	300 g	6-7 mins		
Pears - stewed	500 g	HIGH Micro	8-10 mins	
Plums - poached	400 g	HIGH Micro	6-8 mins	Add 300 ml (½ pt) of water. Only half fill dish. Cover.
Plums - stewed	400 g	STEAM 1 + LOW Micro	9 mins	Place on base of oven.
Rhubarb - stewed	500 g		9 mins	
Game- Caution: Hot fat! Remove accessory with care.				
Duck breast fillets	400 g	200 °C	40 mins	Preheat oven. Prick the skin and place on Square Panacrunch Pan in lower shelf position.
Duck, whole		190 °C	25-27 mins per 450 g	
Pheasant, whole		180 °C	20-25 mins per 450 g plus 20 mins	Preheat oven. Place on Square Panacrunch Pan in lower shelf position.



Points for checking

Always check that food is piping hot after reheating in the microwave. If unsure return to oven. Foods will still require a **stand time**, especially if they cannot be stirred. The denser the food the longer the stand time.

Cooking charts

Food	Weight/ Quantity	Power Level	Time to Select (approx)	Instructions/Guidelines
Lamb - from raw - Caution: Hot Fat! Remove accessory with care.				
Joint	Maximum weight 1.5 kg	180 °C	Medium: 20 mins per 450 g plus 20 minutes or Well done: 30 mins per 450 g plus 25 minutes.	Preheat oven. Place joint on Square Panacrunch Pan in lower shelf position. Once cooked allow the joint to stand for 10 minutes - this will make the joint easier to carve.
Loin/ leg steaks	600 g (4)	GRILL 1	Medium: 19-20 mins Well done: 22-25 mins	Place on Square Panacrunch Pan in upper shelf position. Turn halfway.
Chops/cutlets	400 g (4)	GRILL 1	Medium: 15 mins Well done: 16-18 mins	
Casserole/stewing Lamb	Maximum weight 1.5 kg	160 °C	1hr 20 mins - 1hr 30 mins	Preheat oven. Place in casserole, add stock and vegetables, cover and place on Square Panacrunch Pan in lower shelf position. Stir halfway.
Pasta. Use 3 litre (6 pt) large bowl				
Fusilli/ macaroni/ penne	200 g	HIGH Micro	10 mins	Use 550 ml (1 pint) boiling water. Add 15 ml oil. Cover. Stir halfway.
Linguine/tagliatelle	250 g		12 mins	Use 700 ml (1 ¼ pt) boiling water. Add 15 ml oil. Cover. Stir halfway.
Spaghetti	250 g		8-10 mins	Use 700 ml (1 ¼ pt) boiling water. Add 15 ml oil. Cover. Stir halfway.
Pizza - Fresh chilled - N.B. Remove all packaging. Pizzas will have a soft base if cooked by microwave only.				
Deep pan	555 g	GRILL 1 + SIMMER Micro	9-10 mins	Place on Square Panacrunch Pan in lower shelf position.
Thin and crispy	150 g 250 g 335 g	GRILL 1 + SIMMER Micro	4 mins 6 mins 7 mins	Place on Square Panacrunch Pan in upper shelf position.
Pizza - Frozen - N.B. Remove all packaging.				
Deep pan	440 g	GRILL 1 + LOW Micro	10 mins	Place on Square Panacrunch Pan in upper shelf position.
Individual deep	320 g (2)	GRILL 2 + LOW Micro	9 mins	
Thin and crispy	335 g	GRILL 1 + LOW Micro	7-8 mins	



Points for checking

Always check that food is piping hot after reheating in the microwave. If unsure return to oven. Foods will still require a **stand time**, especially if they cannot be stirred. The denser the food the longer the stand time.

Cooking charts

Food	Weight/ Quantity	Power Level	Time to Select (approx)	Instructions/Guidelines
Porridge - N.B. Use a large bowl.				
1 serving	30 g oats 150 ml (¼ pt) milk	HIGH Micro	2 mins	Place on base and stir halfway.
2 servings	50 g oats 275 ml (½ pt) milk		3 mins 30 secs	
4 servings	100 g oats 550 ml (1 pt) milk		5 mins	
Potato products part cooked - FROZEN				
Croquettes/ smiley faces	300 g	220 °C	15 mins	Preheat oven. Place on Square Panacrunch Pan in upper shelf position. Turn halfway.
Hash browns			15 mins	
Oven fries			15 mins	
Potato wedges			15 mins	
Southern fries			15 mins	
Waffles			10-12 mins	
Rice use 3 litre (6 pt) large bowl				
Basmati	250 g	HIGH Micro	10 mins	Use 550 ml (1 pt) boiling water. Cover and stir halfway.
Easy cook long grain			12 -14 mins	
Long grain white			10-12 mins	Place on base of oven.
Rice pouch			1 min 30 secs - 2 mins	
Sausages from raw - CAUTION: Hot Fat! Remove accessory with care.				
Cocktail sausages	390 g (30)	GRILL 1	14 mins	Place on Square Panacrunch Pan in upper shelf position. Turn halfway.
Thick	454 g (8)		12-15 mins	
Thin	340 g (12)		12 mins	
Vegetarian	300 g (6)		12 mins	
Turkey				
Breasts, boneless and skinless	350 g	STEAM 1	30 mins	Place on Square Panacrunch Pan in upper shelf position.
Crown, off the bone	Maximum weight 1.5 kg	190 °C	32-35 mins. per 450 g	Preheat oven. Place on Square Panacrunch Pan in lower shelf position.



Points for checking

Always check that food is piping hot after reheating in the microwave. If unsure return to oven. Foods will still require a **stand time**, especially if they cannot be stirred. The denser the food the longer the stand time.

Cooking charts

Food	Weight/ Quantity	Power Level	Time to Select (approx)	Instructions/Guidelines
Fresh vegetables				
Asparagus	200 g	STEAM 1 + LOW Micro	6 mins	Place in shallow Pyrex® dish on base of oven.
Baby corn	200 g		5 mins	
Broad beans	200 g		8 mins	
Runner beans	200 g		8 mins	
Beetroot	450 g		15 mins	
Broccoli	250 g		8 mins	
Brussel sprouts	200 g		6 mins	
Butternut squash	300 g		12 mins	
Cabbage - sliced	300 g		12 mins	
Carrots - sliced	200 g		8 mins	
Cauliflower - florets	300 g		7 mins	
Courgettes	250 g		8 mins	
Corn on the cob	x 2		13 mins	
Parsnips - parboiled for roasting sliced	300 g 300 g		6 mins 7 mins	
Peas	200 g		5 mins	
Potatoes - boiled	500 g	15 mins		
Potatoes - par-boiled	500 g	12 mins		
Jacket potatoes - 200-250 g each	x 1 x 2 x 4	HIGH Micro	7 mins 12 mins 23 mins	Place in Pyrex® dish on base of oven.
	x 1 x 2	GRILL 1 + LOW Micro	15 mins 23 mins	Place in Pyrex® dish on base of oven.
Spinach	200 g	STEAM 1 + LOW Micro	5 mins	Place in Pyrex® dish on base of oven.
Sugar snap peas	200 g		8 mins	
Swede - cubed	400 g		12 mins	
Sweet potato	400 g		12 mins	
Turnip	300 g		12 mins	



Points for checking

Always check that food is piping hot after reheating in the microwave. If unsure return to oven. Foods will still require a **stand time**, especially if they cannot be stirred. The denser the food the longer the stand time.

Cooking charts

Food	Weight/ Quantity	Power Level	Time to Select (approx)	Instructions/Guidelines
Frozen vegetables				
Beans - broad	200 g	STEAM 1 + LOW Micro	8 mins	Place in Pyrex® dish on base of oven.
Beans - green	200 g		8 mins	
Broccoli - florets	250 g		8 mins	
Carrots - sliced	200 g		7 mins	
Cauliflower	250 g		10 mins	
Mixed vegetables	200 g		8 mins	
Peas	200 g		7 mins	
Soya beans	200 g		8 mins	
Steam vegetables	150 g		5 mins	
Sweetcorn	200 g		8 mins	



Points for checking

Always check that food is piping hot after reheating in the microwave. If unsure return to oven. Foods will still require a **stand time**, especially if they cannot be stirred. The denser the food the longer the stand time.

Steam only cooking chart

Fill water tank before steaming.

Food	Weight/ Quantity	Power Level	Cooking Time (approx.)	Instructions
Fresh Vegetables e.g. carrots, broccoli	200 g	Steam 1	11-13 mins	Prepare vegetables. Place on Square Panacrunch Pan in upper shelf position.
	300 g		13-15 mins	
Potatoes	200 g	Steam 1	22-24 mins	Cut potatoes into even sized pieces. Place on Square Panacrunch Pan in upper shelf position.
	300 g		27-29 mins	
Frozen Vegetables e.g. carrots, broccoli	200 g	Steam 1	13-15 mins	Place on Square Panacrunch Pan in upper shelf position.
	300 g		15-17 mins	
Fresh Fish	200 g	Steam 1	9-11 mins	Place on Square Panacrunch Pan in upper shelf position. Place fish in a single layer. Do not overlap.
	500 g		14-16 mins	
Frozen fish	200 g	Steam 1	14-16 mins	Place on Square Panacrunch Pan in upper shelf position. Place fish in a single layer. Do not overlap.
	500 g		19-21 mins	
Chicken breast	200 g	Steam 1	27-30 mins	Each breast should weigh between 100-250 g each. Place on Square Panacrunch Pan in upper shelf position

Increasing and decreasing recipes

Increasing recipes

- **To increase a recipe from 4-6 servings**, increase each ingredient listed by half. To double the quantity, simply double every ingredient listed.
- Do not forget that large quantities will require a larger dish. Make sure that it is deep enough to prevent the recipe from boiling over during cooking.
- Cover as directed in the recipe. Stir or rearrange foods as recommended.
- Increase the stand times by 5 minutes per 450 g.
- Always check the recipe during cooking.
- When increasing the ingredients to 6 servings, add an extra one third of the original cooking time, i.e. 30 minutes on MEDIUM power for 4 servings will become 40 mins on MEDIUM power for 6 servings.

- **When doubling a recipe from 4-8**, add on half the original cooking time, i.e. 30 minutes on MEDIUM power for 4 servings will become 45 minutes on MEDIUM power for 8 servings.

Decreasing recipes

- To decrease a recipe from 4 servings to 2 servings, halve the ingredients listed.
- Choose a dish that is proportionally smaller than the one recommended in the recipe, however make sure it is deep enough to stop food boiling over.
- Allow half to two-thirds of the original cooking time, i.e. 30 minutes on MEDIUM power for 4 servings will become 15-20 minutes on MEDIUM power for 2 servings.

Using recipes from other books

The best way to convert a family favourite dish is to find a similar recipe in a cookery book to give you a guide to the correct method and timings to use.

When using other cookbooks, the 1000 W output power of your oven must be allowed for. Use the same power level suggested e.g. HIGH or MEDIUM and select the same cooking time suggested, however **check** the progress of the food during cooking and adjust the time if necessary.

Cooking for one

- For one serving quarter **all** ingredients listed.
- Choose a dish that is proportionally smaller than the one recommended in the recipe.
- Use the same cooking power recommended in the original recipe.
- Start by cooking for one quarter of the recommended cooking time, although extra time in most cases will be required.
- Always check the food during cooking.
- There is not a great saving for reduced quantities of soups, casseroles, stews and rice, as a minimum time is required to tenderise meats and blend flavours.
- When cooking for one it often makes sense to cook for two and plate up both meals. Freeze one meal for a later date.

Sweet potato soup

ingredients

Serves 4

1 medium onion, coarsely chopped
 1 tbsp (15 ml) olive oil
 2 cloves of garlic, crushed
 700 g sweet potato, peeled and chopped
 1 large red pepper, deseeded and chopped
 700 ml vegetable stock
 150 ml coconut milk
 salt and pepper

Dish: 1 x 3 litre Pyrex® casserole dish with lid

Accessory: none

Fill water tank

1. Place the onion, oil and garlic into a casserole dish.
2. Place on the base of the oven and cook on STEAM 1 + LOW MICROWAVE for 4 minutes.
3. Add the potatoes and pepper. Cook on STEAM 1 + LOW MICROWAVE for 10 minutes. Add stock, cover and cook on SIMMER MICROWAVE for 20 minutes, or until the potatoes are soft, stirring halfway.
4. Allow to cool slightly. Place in liquidiser and puree until smooth. Stir in the coconut milk and season to taste.
5. Heat on MEDIUM MICROWAVE for 3 minutes, or until piping hot.

Tomato and red pepper soup

ingredients

Serves 4

5 large tomatoes
 2 tbsp (30 ml) olive oil
 1 onion, chopped
 450 g red pepper, thinly sliced
 2 tbsp (30 ml) tomato puree
 1 pinch sugar
 475 ml vegetable stock
 salt and pepper

Dish: 1 x medium Pyrex® bowl,
 1 x large Pyrex® casserole dish
 with lid

Accessory: none

1. Skin the tomatoes by plunging them in boiling water, in a medium sized bowl, for 30 seconds. Chop the flesh and reserve any juice. Place half the oil in the Pyrex® casserole dish with the onion and cover with pierced cling film. Cook on the base of the oven on HIGH MICROWAVE for 2 minutes, stirring once.
2. Add the peppers and remaining oil, mixing well. Cover and cook on HIGH MICROWAVE for 5 minutes, stirring halfway through cooking. Stir in the chopped tomatoes, tomato purée, seasoning, sugar and a few tablespoons of stock.
3. Cover and cook on HIGH MICROWAVE for 4 minutes, stirring halfway through cooking, until the vegetables are tender. Stir in the rest of the stock and purée in a blender or food processor until smooth. Strain the soup to remove the skins and season to taste.

Brie and cranberry crostini

ingredients

Serves 4

1 small french baguette, sliced
 4 tbsp (60 ml) cranberry sauce
 175 g brie, sliced
 sesame seeds, optional

Dish: none

Accessory: Square Panacrunch Pan

1. Preheat grill on GRILL 1.
2. Place the slices of baguette on the Square Panacrunch Pan in the upper shelf position and toast on GRILL 1 for 2-3 minutes or until lightly toasted.
3. Turn the slices over and spread each slice with cranberry sauce. Top with a slice of brie and sprinkle with sesame seeds.
4. Cook on GRILL 1 + SIMMER MICROWAVE for 6-8 minutes or until cheese has started to melt and sesame seeds turn golden.

Stuffed mushrooms

ingredients

Serves 4

2 rashers streaky bacon
25 g Cheddar cheese, grated
1 tsp (2.5 ml) Dijon mustard
50 g breadcrumbs
1 egg, beaten
4 tbsp (60 ml) milk
1 tbsp (15 ml) fresh parsley,
chopped
4 large flat mushrooms, stalks
removed
4 slices cheddar cheese
1 tomato, thinly sliced

Dish: 1 x medium Pyrex® bowl,

1 x large plate

Accessory: Square Panacrunch
Pan

Fill water tank

1. Cook bacon rashers on a dinner plate on the base of the oven on STEAM 1 + SIMMER MICROWAVE for 2 -4 minutes. When cool, chop into small pieces.
2. In a medium Pyrex® bowl, mix together grated cheese, mustard, bacon and breadcrumbs. Add beaten egg, milk, parsley and seasoning and mix until well combined. Fill mushroom cavities with mixture. Place one tomato slice on top of filling. Place the cheese slices on top of each mushroom.
3. Place mushrooms on the Square Panacrunch Pan in the lower shelf position and cook on STEAM 1 + GRILL 1 for 15-17 minutes or until cheese starts to melt and mushrooms are just cooked.

Onion and feta tarts

ingredients

Serves 6

250 g puff pastry
2 tbsp (30 ml) olive oil
150 g onions, thinly sliced
25 g pine nuts
75 g feta cheese, cubed
25 g black olives, stoned and chopped
25 g sundried tomato in oil, roughly
chopped
10 g capers
Salt and Pepper
Fresh oregano

Dish: 1 x medium Pyrex® bowl

Accessory: Square Panacrunch Pan

Fill water tank

1. Roll out the puff pastry and cut out 6 circles, each about 10 cm diameter. Refrigerate the pastry for approximately 30 minutes.
2. Put the oil and onion in a medium Pyrex® bowl. Cook on the base of the oven on STEAM 1 + LOW MICROWAVE for 10 minutes. Add the pine nuts, cheese, olives, sun-dried tomatoes and capers to the onions. Season.
3. Preheat the oven on OVEN 220 °C.
4. Line the Square Panacrunch Pan with baking paper. Place 6 pastry circles on the Square Panacrunch Pan and prick them with a fork.
5. Divide the mixture between the six pastry circles. Cook the tartlets in the lower shelf position on OVEN 220 °C for 15 minutes or until golden. Sprinkle with fresh oregano.

Prawn risotto

ingredients

Serves 4

1 onion, finely chopped
 1 clove of garlic, crushed
 25 g butter
 225 g brown cap mushrooms, quartered
 225 g risotto rice
 1 lemon, zest and juice
 ½ tsp (2.5 ml) saffron strands, crushed
 300 ml hot vegetable stock
 300 ml white wine
 100 g frozen peas
 300 g cooked peeled prawns
 2 tbsp (30 ml) chives, finely chopped

Dish: 1 x large Pyrex® casserole dish

Accessory: none

Fill water tank

1. Put the onion, garlic, butter and mushrooms in a large Pyrex® casserole dish. Place on the base of the oven and cook on STEAM 1 + LOW MICROWAVE for 10 minutes. Add rice, juice and rind of the lemon, saffron, stock and wine to the mushroom mixture.
2. Cook on STEAM 1 + LOW MICROWAVE for 10 minutes. Stir risotto. Add peas, and cook on STEAM 1 + LOW MICROWAVE for 8 minutes. Add the prawns and chives and cook on STEAM 1 + LOW MICROWAVE for 4 minutes.
3. Leave to stand for 2-3 minutes and serve.

Thai steamed trout

ingredients

Serves 2

2 trout fillets, approx 140 g each
 2 cloves of garlic, finely chopped
 1-2 small red chilli, finely chopped
 1 lime, zest and juice
 4 spring onions, finely chopped
 2 tbsp (30 ml) light soy sauce

Dish: 1 x Pyrex® shallow dish

Accessory: Square Panacrunch Pan

Fill water tank

1. Place fish fillets into a shallow dish, sprinkle the remaining ingredients on the top of the fish.
2. Place dish on the Square Panacrunch Pan in the lower shelf position, cook on STEAM 1 for 10-15 minutes, or until the fish is cooked through.

Mediterranean fish bake

ingredients

Serves 2

½ lemon, juiced
 100 g fresh pesto
 salt and pepper
 4 x 175 g haddock or cod fillets
 700 g waxy new potatoes
 2 medium red onions, roughly chopped
 1 red pepper, deseeded and chopped
 1 yellow pepper, deseeded and chopped
 1 orange pepper, deseeded and chopped
 2 cloves of garlic, crushed
 1 tbsp (15 ml) olive oil
 100 g black olives, chopped

Dish: 1 x small Pyrex® bowl, 1 x large rectangular Pyrex® dish

Accessory: Square Panacrunch Pan

Fill water tank

1. In a small bowl, mix lemon juice, pesto and seasoning together. Place fish in a large rectangular dish and spoon over the marinade. Leave in the fridge for 1-2 hours.
2. Toss vegetables with the garlic and oil. Place on the Square Panacrunch Pan in the lower shelf position and cook on STEAM 1 + OVEN 220 °C for 30 minutes. Scatter the black olives over the vegetables and place the fish and marinade on top of the vegetables.
3. Cook on GRILL 3 + LOW MICROWAVE for 15-20 minutes or until cooked through.

Moules mariniere

ingredients

Serves 2

900 g mussels (weight in shell)
15 g butter
2 shallots, finely sliced
1 clove of garlic, crushed
150 ml white wine
1 bunch flat leaf parsley, finely chopped
100 ml double cream

Dish: 1 x large Pyrex® casserole dish with lid, 1 x serving dish

Accessory: Square Panacrunch Pan
Fill water tank

1. Scrub mussels and pull off any beards discarding any broken or open shells.
2. Place butter, shallots and garlic in a large Pyrex® dish, cover. Place on the base of the oven and cook on HIGH MICROWAVE for 3 minutes.
3. Add wine and cook on HIGH MICROWAVE for 3 minutes. Put to one side.
4. Spread the mussels out on the Square Panacrunch Pan in the upper shelf position. Cook on STEAM 1 for 20 minutes. Discard any unopened shells.
5. Add the parsley and cream to the sauce and pour in half of the liquid collected in the Square Panacrunch Pan and cook, covered, on HIGH MICROWAVE for 3 minutes. Place the mussels into a serving dish and pour the sauce over.

Steamed garlic prawns

ingredients

Serves 2

25 g butter
4 cloves of garlic, crushed
250 ml white wine
400 ml chicken stock
salt and pepper
450 g raw king prawns
1 tbsp (15 ml) cornflour
1 handful parsley, chopped

Dish: 1 x large Pyrex® casserole dish with lid

Accessory: Square Panacrunch Pan
Fill water tank

1. Place the butter and garlic into a Pyrex® casserole dish, cover. Cook on the base of the oven on HIGH MICROWAVE for 1 minute.
2. Add the wine and chicken stock to the garlic and cook covered on HIGH MICROWAVE for 5 minutes, uncover and cook for a further 5 minutes. Season and set to one side.
3. Place the prawns on the Square Panacrunch Pan in the upper shelf position and cook on STEAM 1 for 15 minutes.
4. Remove the prawns from the oven. Add the cornflour and parsley to the sauce, stir thoroughly and cook, covered for a further 3 minutes, on HIGH MICROWAVE, stirring halfway.
5. Mix the prawns into the sauce and serve with crusty bread.

Spicy tuna pasta bake

ingredients

Serves 2

250 g fusilli pasta
1 litre boiling water
1 tsp (5 ml) olive oil
1 medium red pepper, sliced
1 medium yellow pepper, sliced
2 cloves of garlic, crushed
1 tsp (5 ml) crushed dried chillies
2 x 400 g tins chopped tomato
1 tsp (5 ml) granulated sugar
2 x 200 g tins tuna, drained
25 g fresh breadcrumbs
2 tbsp (30 ml) parmesan, grated

Dish: 1 x large Pyrex® casserole dish with lid, 1 x 24 x 24 cm Pyrex® shallow dish

Accessory: Square Panacrunch Pan

1. Place pasta in large Pyrex® casserole dish and add water. Cover, place on the base of oven and cook on HIGH MICROWAVE for 10 minutes, or until soft. Leave to stand for 2-3 minutes. Drain.
2. Place the oil and peppers in the shallow dish and cook on HIGH MICROWAVE for 5 minutes, until the peppers have slightly softened.
3. Add the garlic and chilli to the pepper mixture and cook on HIGH MICROWAVE for 1 minute.
4. Add the tomatoes and sugar, stir and cook on HIGH MICROWAVE for a further 5 minutes.
5. Stir tuna and pasta into the tomato and pepper mixture until coated. Top with breadcrumbs and parmesan.
6. Place the dish on the base of the oven and cook on GRILL 1 LOW MICROWAVE for 5-7 minutes, or until golden.

Lasagne

ingredients

Serves 4

Meat Sauce:

- 1 onion, chopped
- 1 clove of garlic, crushed
- 1 tsp (5 ml) oil
- 400 g tin chopped tomatoes
- 150 ml red wine
- 2 tbsp (30 ml) tomato puree
- 1 tsp (5 ml) mixed herbs
- 500 g minced beef
- salt and pepper

Lasagne

- 1 quantity white sauce (see page 94)
- 100 g Cheddar cheese, grated
- 1 tsp (5 ml) mustard
- salt and pepper
- 250 g fresh lasagne
- 50 g parmesan, grated

Dish: 1 x 1.5 litre Pyrex® casserole dish with lid

1 x large Pyrex® gratin dish

Accessory: none

1. Place onion, garlic and oil in casserole dish. Place on the base of the oven and cook on HIGH MICROWAVE for 2-3 minutes. Place all other meat sauce ingredients in casserole dish. Stir well. Cover, cook on HIGH MICROWAVE for 10 minutes. Then MEDIUM MICROWAVE for 15-20 minutes or until cooked.
2. Add mustard and grated cheese to white sauce.
3. Cover the base of the Pyrex® gratin dish with a layer of white sauce, then a layer of lasagne, then a layer of hot meat mixture. Continue with a layer of lasagne then meat, ending with a layer of white sauce. Sprinkle parmesan cheese over the top.
4. Place on the base of the oven and cook on GRILL 1 + LOW MICROWAVE for 10 minutes. Then GRILL 1 for 5-10 minutes or until golden brown.

Mini boeuf en croute

ingredients

Serves 4

- 15 g dried porcini mushrooms
- 15 g butter
- 225 g mushrooms
- 1 large onion, finely chopped
- 150 ml red wine
- 4 fillet steaks (roughly 150 g each)
- 375 g puff pastry
- 1 large egg, beaten
- salt and pepper

Dish: 1 x small Pyrex® bowl

1 x large Pyrex® casserole dish

Accessory: Square Panacrunch Pan

1. In a small Pyrex® bowl, soak porcini mushrooms in boiling water for 20 minutes. Drain and finely chop.
2. Put the butter, all the mushrooms and onions in a large Pyrex® casserole dish and cover. Place on the base of the oven and cook on HIGH MICROWAVE for 3 minutes. Add wine to the mushroom mixture and cook on HIGH MICROWAVE for 7-8 minutes.
3. Preheat the oven on OVEN 200 °C. Place the fillets on the Square Panacrunch Pan in the lower shelf position and cook on OVEN 200 °C for 10-15 minutes. Allow to cool. Wash Square Panacrunch Pan.
4. Cut the pastry into 4 pieces and roll each piece out to a 15 cm x 15 cm square and brush with beaten egg.
5. Drain the mushroom mixture, place a ¼ of the mixture into the centre of each pastry square and place a fillet on top. Season. Bring the corners of the pastry to the centre. Line the Square Panacrunch Pan with baking paper. Place the pastry on the Square Panacrunch Pan.
6. Brush with beaten egg. Cook in the lower shelf position on OVEN 220 °C for 25 minutes for medium and 30 minutes for well done.

Shepherd's pie

ingredients

Serves 4

1 kg potatoes, peeled and chopped
 2 tbsp (30 ml) milk
 1 medium onion, chopped
 2 medium carrots, peeled and chopped
 25 g butter
 350 g minced lamb
 275 ml hot lamb stock
 1 tbsp (15 ml) worcestershire sauce
 1 tbsp (15 ml) cornflour
 1 tbsp (15 ml) tomato puree
 50 g Cheddar cheese, grated

Dish: 2 x large Pyrex® casserole dish with lid, 1 x large Pyrex® gratin dish

Accessory: none

1. Place potatoes in a large Pyrex® Casserole dish with 3 tbsp (45 ml) water. Cover, place on the base of the oven and cook on MEDIUM MICROWAVE for 15-17 minutes until soft. Drain and mash well with the milk.
2. Place onion, carrots and butter into large Pyrex® casserole dish. Place on the base of the oven and cook on MEDIUM MICROWAVE for 5-7 minutes or until soft.
3. Add minced meat to vegetables. Then add stock, worcestershire sauce, cornflour and tomato puree and season to taste. Cover and cook on HIGH MICROWAVE for 15 minutes.
4. Transfer the meat mixture into a large Pyrex® gratin dish. Spread potato on top of the meat, using a fork to make a pattern on top. Sprinkle with cheese.
5. Place dish on the base of the oven and cook on GRILL 1 + LOW MICROWAVE for approximately 20 minutes or until top is crisp and golden.

Chicken pasanda

ingredients

Serves 4

3 cardamom pods
 ½ cinnamon stick
 ¼ tsp (1.25 ml) cumin seeds
 1 tsp (5 ml) garam masala
 1 tsp (5 ml) chilli flakes
 2.5 cm fresh root ginger, grated
 1 clove of garlic, crushed
 25 g ground almonds
 3 tbsp (45 ml) natural yoghurt
 4 chicken breasts, skinned and cut into bite sized pieces
 1 tbsp (15 ml) olive oil
 2 medium onions, finely chopped
 150 ml single cream
 2 tbsp (30 ml) fresh coriander, chopped

Dish: 1 x 3 litre Pyrex® casserole dish with lid, 1 x large Pyrex® bowl

Accessory: none

1. Place the cardamom, cinnamon, cumin, garam masala, chilli, ginger, garlic, almonds and yoghurt into a large Pyrex® bowl. Add chicken and stir well. Leave to marinate in the fridge for 2-3 hours.
2. Place oil and onions in a large Pyrex® casserole dish. Place on the base of the oven and cook on HIGH MICROWAVE for 2 minutes. Stir chicken into onions.
3. Cover, place casserole on the base of the oven and cook on MEDIUM MICROWAVE for 15 minutes. Stir. Cook for a further 10-15 minutes on MEDIUM MICROWAVE. Stir in cream and coriander and cook on MEDIUM MICROWAVE for 3 minutes or until hot.

Steamed chicken and noodles

ingredients

Serves 4

2 large chicken breasts
 3 tbsp (45 ml) fresh coriander, chopped
 2.5 cm piece ginger, cut into strips
 6-8 spring onions, finely chopped
 2 cloves of garlic, crushed
 1 red chilli, finely chopped
 3 tbsp (45 ml) soy sauce
 2 tbsp (30 ml) rice vinegar
 1 tsp (5 ml) light brown sugar
 2 tbsp (30 ml) groundnut oil
 1 tbsp (15 ml) vegetable oil
 1 tsp (5 ml) sesame oil
 200 g fresh egg noodles

Dish: 2 x small Pyrex® bowl,
 1 x large Pyrex® bowl

Accessory: Square Panacrunch Pan
 Fill water tank

1. Place the chicken breasts between two sheets of cling film and flatten with a meat mallet or rolling pin until thin. Remove the cling film, place the chicken breasts onto the Square Panacrunch Pan and season well. Place in the upper shelf position and cook on STEAM 1 for 15-20 minutes, or until the chicken is cooked through.
2. Place the chopped coriander, ginger, spring onions, crushed garlic, red chilli, soy sauce, rice vinegar and light brown sugar into a small Pyrex® bowl and mix well.
3. Place the oils into a small Pyrex® bowl and heat on the base of the oven on MEDIUM MICROWAVE for 1-2 minutes. Pour over the spring onion mixture and mix to combine.
4. In a large bowl, place noodles and cover with boiling water. Cook on the base of the oven on STEAM 1 for 8 minutes. Drain.
5. To serve, place the cooked egg noodles into shallow serving bowl. Slice the cooked chicken and spoon over the spring onion mixture and drizzle over the juices from the bowl.

Spicy lamb tagine

ingredients

Serves 4

¾ tbsp (10 ml) ground ginger
 ½ tsp (2.5 ml) ground black pepper
 1½ tsp (7.5 ml) ground cinnamon
 ¾ tbsp (10 ml) turmeric
 1 tbsp (15 ml) paprika
 ½ tsp (2.5 ml) chilli powder
 800 g boneless lamb, cubed
 2 tbsp (30 ml) oil
 2 medium onions, chopped
 2 cloves of garlic, crushed
 2 medium carrots, sliced
 ½ tsp (2.5 ml) salt
 150 g ready to eat dried apricots, chopped
 40 g sultanas
 65 g flaked almonds, toasted, thickly sliced
 ¾ tbsp (10 ml) honey
 150 ml tomato juice
 400 g tin chopped tomatoes
 300 ml vegetable stock

Dish: 1 x 3 litre Pyrex® casserole dish with lid, 1 x large Pyrex® bowl

Accessory: Square Panacrunch Pan

1. Put spices into a large Pyrex® bowl and mix well. Add lamb and evenly coat with spices.
2. Place oil, onions, garlic and carrots in a large Pyrex® casserole dish. Place on the base of the oven and cook on LOW MICROWAVE for 5 minutes.
3. Add lamb mixture and mix thoroughly. Stir in remaining ingredients and cover. Place on the Square Panacrunch Pan in the lower shelf position and cook on OVEN 160 °C for 1 hour 30 minutes or until tender, stir halfway.

Cheesy chicken gratin

ingredients

Serves 4

250 g leek, finely sliced
25 g butter
25 g plain flour
300 ml whole milk
225 g cooked chicken, chopped
100 g ham, chopped
150 g gruyere cheese, grated

Dish: 1 x large Pyrex® bowl,
1 x 20 x 25 cm Pyrex® gratin dish

Accessory: Square Panacrunch Pan
Fill water tank

1. Place the leeks in a large Pyrex® bowl with the butter. Place on the base of the oven and cook on STEAM 1 + LOW MICROWAVE for 6 minutes or until softened.
2. Add the flour and mix well. Stir in the milk and heat on HIGH MICROWAVE for 4-5 minutes or until thickened, stirring halfway.
3. Add the chicken, ham and cheese then season and mix well. Pour into the gratin dish.
4. Place on the base of the oven and cook on GRILL 1 + LOW MICROWAVE for 10-15 minutes or until piping hot and golden.

Chicken tikka skewers

ingredients

Serves 4

150 g low fat natural yoghurt
2 tbsp (30 ml) hot curry paste
300 g chicken breast, skinned and cut into bite sized pieces
12 cherry tomatoes

Dish: 4 x wooden skewers

1 x medium Pyrex® bowl

Accessory: Square Panacrunch Pan
Fill water tank

1. Mix the yoghurt and curry paste together in a medium Pyrex® bowl, then add the chicken. Marinate for an hour.
2. Thread the chicken pieces and cherry tomatoes onto the skewers.
3. Place skewers on the Square Panacrunch Pan in the upper shelf position. Cook on GRILL 1 + STEAM 1 for 10 minutes, turn the skewers over, then cook on GRILL 1 + STEAM 1 for 8-10 minutes or until cooked through.

Glazed gammon

ingredients

Serves 4

900 g unsmoked gammon joint
cold water to cover
1 onion, peeled
16 whole cloves
10 peppercorns
3 tbsp (45 ml) honey
2 tbsp (30 ml) orange juice
15 g demerara sugar

Dish: 1 x 3 litre Pyrex® casserole dish
with lid, 1 x Pyrex® square dish,
1 x small Pyrex® bowl

Accessory: Square Panacrunch Pan

1. Place gammon in a large Pyrex® casserole dish. Add onion stuck with 4 cloves and peppercorns and cover with water.
2. Cover, place on base of oven and cook on HIGH MICROWAVE for 15 minutes then MEDIUM MICROWAVE for 35-40 minutes, or until cooked. Drain.
3. In a small bowl, mix together the honey, orange juice, sugar and mustard. Cook on HIGH MICROWAVE for 1 minute. Leave to cool.
4. Remove the gammon rind. Score the fat in a lattice pattern and stud with remaining cloves. Brush over half of the glaze.
5. Preheat oven on OVEN 180 °C. Place gammon in square Pyrex® dish on Square Panacrunch Pan in lower shelf position and cook on OVEN 180 °C 10-15 minutes until golden, spreading over the remaining glaze halfway through cooking time.

Pesto chicken crumble

ingredients

Serves 4

500 g new potatoes, halved
 3 tbsp (45 ml) pesto
 1 tbsp (15 ml) oil
 1 medium onion, finely chopped
 4 chicken breasts, skinned and cut into bite sized pieces
 400 g tin chopped tomatoes
 2 tbsp (30 ml) tomato puree
 4-5 drops Tabasco sauce
 100 g breadcrumbs
 1 clove of garlic, finely chopped
 50 g parmesan cheese, grated

Dish: : 1 x medium Pyrex® casserole dish with lid, 1 x Pyrex® gratin dish

Accessory: none

1. Place potatoes in a medium Pyrex® casserole dish with 3 tbsp (45 ml) water. Cover, place on the base of the oven and cook on HIGH MICROWAVE for 7-8 minutes. Drain. Stir the pesto into the potatoes and put aside to keep warm.
2. Place oil and onion in a gratin dish. Place on the base of the oven and cook on HIGH MICROWAVE for 2-3 minutes to soften the onion.
3. Add chicken, cover and cook on MEDIUM MICROWAVE for 4 minutes. Add the tomatoes, tomato puree and the Tabasco sauce to the chicken. Cover and cook on MEDIUM MICROWAVE for 10-12 minutes. Stirring halfway. Add potatoes.
4. Mix the breadcrumbs with the garlic and Parmesan cheese and sprinkle over the chicken.
5. Place dish on the base of the oven and cook on GRILL 1 + LOW MICROWAVE for 8-10 minutes until heated through and golden brown in colour.

Stuffed aubergines

ingredients

Serves 4

2 large aubergines
 1 clove of garlic, crushed
 1 medium onion, chopped
 200 g minced beef
 400 g tin chopped tomatoes
 25 g pitted black olives, chopped
 2 tsp (10 ml) dried oregano
 2 tbsp (30 ml) tomato puree
 75 g breadcrumbs
 50 g parmesan, grated

Dish: 1 x 1.5 litre Pyrex® casserole dish with lid

Accessory: Square Panacrunch Pan

1. Place the whole aubergines on the Square Panacrunch Pan in the lower shelf position and cook on OVEN 220 °C for 20 minutes or until soft. Remove from oven and allow to cool.
2. Cut the aubergines in half horizontally, leaving the stalks attached. Scoop out the flesh and chop finely.
3. Place garlic and onion in a Pyrex® casserole dish. Place on the base of the oven and cook on HIGH MICROWAVE for 2 minutes.
4. Add beef, tomatoes, aubergine flesh, olives, oregano, and tomato puree. Cover and cook on HIGH MICROWAVE for 10 minutes. Mix 40 g of the parmesan with the breadcrumbs and add to beef mixture. Fill the aubergine skins with the filling.
5. Place aubergines on the Square Panacrunch Pan and sprinkle with the remaining parmesan.
6. Place the Square Panacrunch Pan in the lower shelf position and cook on GRILL 1 for 5 minutes, or until cooked and golden.

Pork with herby dumplings

ingredients

Serves 4

2 tbsp (30 ml) oil
 1 medium onion, chopped
 1 green pepper, deseeded and chopped
 2 medium carrots, peeled and sliced
 450 g lean pork, cubed
 2 tbsp (30 ml) seasoned flour
 1 bay leaf
 1 tsp (5 ml) sage
 300 ml dry cider

Dumplings

175 g self raising flour
 75 g suet
 1 pinch salt
 5 ml (1 tsp) mustard powder
 1 tbsp (15 ml) fresh parsley, chopped
 150 ml cold water

Dish: 1 x 3 litre Pyrex® casserole dish with lid, 1 x medium Pyrex® bowl

Accessory: Square Panacrunch Pan
Fill water tank

1. Place oil, onion, green pepper and carrots in Pyrex® casserole dish. Place on the base of the oven and cook on STEAM 1 + LOW MICROWAVE for 6 minutes.
2. Toss pork in seasoned flour and add to onion mixture. Stir in all other ingredients. Cover and place the Square Panacrunch Pan in the lower shelf position and cook on OVEN 160 °C for 1 hour or until pork is tender.
3. Whilst cooking, in a medium Pyrex® bowl, make the dumplings by combining the flour, suet, salt, mustard and parsley. Add the water to make a stiff dough. Shape dough into 8 round dumplings. When pork is cooked, uncover and place dumplings around the edge of dish.
4. Continue to cook uncovered on OVEN 160 °C for 15-20 minutes or until dumplings are cooked through.

Pork with lentils

ingredients

Serves 4

250 g brown lentils
 1 large onion, chopped
 4 rashers smoked bacon, diced
 1 pinch thyme
 1 stock cube
 230 g smoked sausage
 salt and pepper

Dish: 1 x 2 litre Pyrex® casserole dish with lid

Accessory: none

1. Place the lentils in a Pyrex® casserole dish. Cover in cold water. Place the dish on the base of the oven, bring to the boil on HIGH MICROWAVE for 7-8 minutes. Drain and allow to cool.
2. Place lentils in the Pyrex® casserole dish with the chopped onion, the diced smoked bacon, a pinch of thyme and the stock cube. Cover with water.
3. Cook, covered on the base of the oven on HIGH MICROWAVE, for 12 minutes then 40-50 minutes on SIMMER MICROWAVE. 20 minutes before the end of the cooking add the smoked sausages. Season before serving.

Greek lamb stew

ingredients

Serves 4

700 g lamb fillet, cut into chunks
 2 onions, chopped
 1 red chilli
 2 cloves of garlic, crushed
 1 sprig rosemary
 275 ml white wine
 400 g tin chopped tomatoes
 3 tbsp (45 ml) black olives, sliced
 100 g linguine, broken into pieces
 150 g feta cheese, cubed
 1 tbsp (15 ml) fresh mint, chopped

Dish: 1 x 3 litre Pyrex® casserole dish with lid

Accessory: none

Fill water tank

1. Place the lamb and onion in a Pyrex® casserole dish and cover. Place on the base of the oven and cook on STEAM 1 + LOW MICROWAVE for 10 minutes.
2. Split the chili along its length leaving the top intact, remove seeds - this adds flavour to the stew without too much heat.
3. Stir the chilli, garlic, rosemary, wine and tomatoes into the lamb. Cook, covered on LOW MICROWAVE for 40 minutes stirring halfway. Stir in the black olives and linguine and continue to cook on LOW MICROWAVE for a further 15 minutes or until the linguine is cooked.
4. Remove the chilli and rosemary, and discard. Stir in feta cheese and mint before serving.

Cannelloni

ingredients

Serves 4

8 quick cook cannelloni tubes
 1 quantity white sauce (see page 94)
 50 g Cheddar cheese, grated

Filling

100 g fresh spinach
 150 g cooked ham, chopped
 1 egg, beaten
 1 tbsp (15 ml) parsley, chopped
 1 tbsp (15 ml) spring onions, finely chopped
 6 tbsp (90 ml) parmesan, grated

Dish: 1 x large Pyrex® bowl

1 x medium gratin dish

Accessory: Square Panacrunch Pan

1. Add the grated cheese to the white sauce, mix well. Set aside.
2. Preheat the oven on OVEN 190 °C
3. In a large Pyrex® bowl combine all filling ingredients and 2 tbsp (30 ml) of Parmesan cheese. Spoon the filling from each end into the cannelloni tubes using a teaspoon.
4. Lay cannelloni in base of a medium gratin dish. Pour over sauce and sprinkle with the remaining 4 tbsp (60 ml) Parmesan cheese.
5. Cook on the Square Panacrunch Pan in the lower shelf position OVEN 190 °C for approx. 25-30 minutes or until bubbling and golden brown.

Cauliflower cheese

ingredients

Serves 4

1 large cauliflower, divided into florets
 25 g butter
 25 g flour
 ½ tsp (2.5 ml) French mustard
 300 ml whole milk
 100 g cheese, grated
 25 g breadcrumbs

Dish: 1 x medium Pyrex® shallow dish, 1 x 1.5 litre Pyrex® jug

Accessory: Square Panacrunch Pan
Fill water tank

1. Place cauliflower florets on the Square Panacrunch Pan in the upper shelf position. Cook on the AUTO STEAM FRESH VEGETABLES program. Drain.
2. Melt butter in a jug on HIGH MICROWAVE for 20-30 seconds. Stir in flour and mustard. Cook for a further 15 seconds. Add milk gradually. Stir well and season. Cook on HIGH MICROWAVE for 3-4 minutes. Or until sauce is thick and bubbling. Stir halfway. Stir in 90 g cheese.
3. Place the cauliflower into a shallow Pyrex® dish. Pour the cheese sauce over the cauliflower. Top with remaining cheese and breadcrumbs. Place dish on base of the oven and cook on GRILL 1 + LOW MICROWAVE for 5-10 minutes. or until golden brown.

Ratatouille

ingredients

Serves 4

1 aubergine, sliced
 1 onion, sliced
 2 tbsp (30 ml) olive oil
 1 clove of garlic, crushed
 1 courgette, sliced
 1 green pepper, sliced
 400 g tin chopped tomatoes
 1 tbsp (15 ml) mixed herbs
 salt and pepper

Dish: 1 x large Pyrex® casserole dish with lid

Accessory: none

1. Combine all ingredients in a Pyrex® casserole dish.
2. Cover and cook on the base of the oven on LOW MICROWAVE for 20-25 minutes. or until vegetables are soft. Stir halfway through cooking time.

Steamed carrots with orange, cumin and thyme

ingredients

Serves 4

1 pinch sugar
 ¼ orange, zested
 1 pinch cumin seeds
 1 tbsp (15 ml) thyme
 60 g butter, softened
 250 g carrots, sliced

Dish: Pestle and mortar

Accessory: Square Panacrunch Pan
Fill water tank

1. Use a pestle and mortar, to press sugar, zest, cumin seeds and thyme together. Then add the butter and mix well. Spoon the mixture onto a sheet of greaseproof paper and roll into a cylinder, twisting both ends to seal. Place in the freezer to firm up.
2. Place sliced carrots on the Square Panacrunch Pan. Cook on the upper shelf position on the AUTO STEAM FRESH VEGETABLES program.
3. Slice the flavoured butter, and serve the carrots with butter melted over the top.

Steamed courgettes with tomato and chilli

ingredients

Serves 4

1 clove of garlic, chopped
 ½ red chilli, deseeded and finely chopped
 2 sun dried tomato in oil, drained and roughly chopped
 60 g butter, softened
 300 g courgettes, sliced

Dish: *Pestle and mortar*

Accessory: *Square Panacrunch Pan*

Fill water tank

1. Use a pestle and mortar, to press garlic, chilli and sun-dried tomatoes to a paste. Add butter and mix well. Spoon the mixture onto a sheet of greaseproof paper and roll into a cylinder, twisting both ends to seal. Place in the freezer to firm up.
2. Place the courgettes on the Square Panacrunch Pan. Cook in the upper shelf position on the AUTO STEAM FRESH VEGETABLES program.
3. Slice the flavoured butter, and serve the courgettes with butter melted over the top.

Steamed mange tout with citrus butter

ingredients

Serves 4

½ lemon, zest and juice
 salt and pepper
 60 g butter, softened
 200 g mange tout

Dish: *1 x small Pyrex® mixing bowl*

Accessory: *Square Panacrunch Pan*

Fill water tank

1. Mix all ingredients except the mange tout together. Spoon the mixture onto a sheet of greased proof paper and roll into a cylinder, twisting both ends to seal. Keep refrigerated.
2. Place the mange tout on the Square Panacrunch Pan. Cook in the upper shelf position on the AUTO STEAM FRESH VEGETABLES program.
3. Slice the flavoured butter, and serve the mange tout with butter melted over the top.

Vegetarian chilli

ingredients

Serves 4

1 tbsp (15 ml) oil
 1 medium onion, finely chopped
 1 green pepper, deseeded and chopped
 1 chilli, finely chopped
 2 medium carrots, peeled and chopped
 1 tsp (5 ml) chilli powder
 ½ tsp (2.5 ml) cumin
 175 g bulgar wheat
 400 g tin chopped tomato
 2 tbsp (30 ml) tomato puree
 450 ml water
 400 g tin kidney beans, drained

Dish: *1 x 3 litre Pyrex® casserole dish with lid*

Accessory: *none*

1. Place oil, onion, pepper, chilli and carrots in a large Pyrex® casserole. Cover and place on the base of the oven and cook on HIGH MICROWAVE for 4-5 minutes or until softened.
2. Add chilli, cumin, bulgar wheat, chopped tomatoes, tomato puree and water. Cover and cook on HIGH MICROWAVE for 10 minutes.
3. Stir in red kidney beans, cover and cook on HIGH MICROWAVE for 5 minutes.

Roast vegetable parcels

ingredients

Serves 4

200 g tin chopped tomatoes
 2 tsp (10 ml) tomato puree
 500 g mixed vegetables e.g. red pepper, leeks, aubergine, red onion, chopped into small chunks
 1 clove of garlic, crushed
 1 tbsp (15 ml) olive oil
 25 g pine nuts
 50 g gruyere cheese, grated
 100 g Boursin cheese
 1 tsp (15 ml) single cream
 350 g ready made puff pastry
 1 egg, beaten to glaze

Dish: 1 x medium Pyrex® shallow dish, 2 x small Pyrex® bowl

Accessory: Square Panacrunch Pan

1. Place the chopped tomatoes and puree in a small Pyrex® bowl. Place on the base of the oven and cook on HIGH MICROWAVE for 5 minutes then MEDIUM MICROWAVE for 5-6 minutes or until mixture is reduced in volume and thickened.
2. Place the vegetables, garlic and oil in a Pyrex® shallow dish. Place on the Square Panacrunch Pan in the lower shelf position and cook on OVEN 220 °C for 20-30 minutes.
3. Mix the tomato sauce with the cooked vegetables and pine nuts, continue to cook on OVEN 220 °C. Allow to cool.
4. Preheat oven on OVEN 220 °C.
5. In a small Pyrex® bowl, mix together the gruyere cheese, Boursin and single cream.
6. Roll out pastry until it measures approx 30 cm square. Divide into 4 equal squares. Place ¼ of the vegetable mixture in the centre of one of the squares and top with ¼ of the cheese mixture. Bring the corners of the pastry to the centre, pressing the edges together. Seal with water and glaze with beaten egg, repeat 3 times.
7. Line the Square Panacrunch Pan with baking paper. Place parcels on the Square Panacrunch Pan in the lower shelf position and cook on OVEN 220 °C for 15- 20 minutes or until the pastry is golden and crisp.

Bean enchiladas

ingredients

Serves 4

1 onion, chopped
 250 g carrots, grated
 1 tbsp (15 ml) olive oil
 2 tsp (10 ml) mild chilli powder
 1 tsp (5 ml) ground cumin
 400 g tin chopped tomato
 400 g tin baked beans, drained
 400 g tin mixed beans, drained
 6 small tortillas
 200 g low fat natural yoghurt
 50 g cheese, grated

Dish: 1 x large Pyrex® casserole dish with lid, 1 x medium Pyrex® square dish.

Accessory: Square Panacrunch Pan

1. Place the onion and carrots with the olive oil in a large Pyrex® casserole dish. Cook on the base of the oven HIGH MICROWAVE for 5-6 minutes. Stir halfway through cooking.
2. Stir in the chilli powder and ground cumin. Cook on HIGH MICROWAVE for 1 minute. Stir in the tomatoes and beans. Cover and bring to the boil on HIGH MICROWAVE for 8-10 minutes then cook on SIMMER MICROWAVE for 10 minutes stirring occasionally.
3. Spread a thin layer of the mixture over the base of the square Pyrex® dish. Fill each tortilla with a few tablespoons of the mixture, fold over the ends and roll up to seal. Place into the dish seal side down. Cover with the remaining mixture. Mix the yoghurt and grated cheese together and spoon evenly over the dish.
4. Place the dish on the Square Panacrunch Pan in the lower shelf position and brown on GRILL 1 for 10-15 minutes.

Porcini mushroom risotto

ingredients

Serves 4

40 g dried porcini mushrooms
1 onion, chopped
250 g risotto rice
50 g butter
1 clove of garlic, crushed
1 vegetable stock cube
1 small bunch basil leaves, chopped

Dish: 1 x small Pyrex® bowl,
1 x 3 litre Pyrex® casserole dish

Accessory: none

Fill water tank

1. In a small Pyrex® bowl, soak the mushrooms in 400 ml warm water for at least 2 hours.
2. Mix the onion, rice and butter in the Pyrex® casserole dish. Cook on the base of the oven on STEAM 1 + LOW MICROWAVE for 6 minutes.
3. Add the water from the mushrooms plus more water to make up to a litre, the crushed garlic and the vegetable stock cube.
4. Cook, uncovered on the base of the oven on STEAM 1 for 20 minutes. Half way through the cooking time, add the roughly chopped mushrooms and basil and a little more water if necessary. Season and serve.

Stuffed courgettes

ingredients

Serves 4

2 courgettes, halved lengthways
2 tsp (10 ml) extra virgin olive oil
Stuffing
30 g breadcrumbs
20 g pine nuts
3 spring onions, finely chopped
1 clove of garlic, crushed
1 tsp (5 ml) dried thyme
20 g parmesan, grated

Dish: 1 x small mixing bowl

Accessory: Square Panacrunch Pan

Fill water tank

1. Place courgettes on the Square Panacrunch Pan in the upper shelf position and cook on STEAM 1 for 15 minutes.
2. Preheat oven on OVEN 200 °C
3. For the stuffing, mix all the ingredients together in a small Pyrex® bowl. Sprinkle the mixture on the top of the courgettes and drizzle with the remaining olive oil.
4. Cook on the Square Panacrunch Pan in the lower shelf position for 10-15 minutes on OVEN 200 °C or until golden.

Roasted vegetable moussaka

ingredients

Serves 4

1 medium red onion, sliced
2 red peppers, deseeded and chopped
1 aubergine, cubed
2 courgettes, cubed
200 g sweet potato, peeled and chopped
4 cloves of garlic, whole
3 tbsp (45 ml) olive oil
400 g tin chopped tomatoes
25 g sun-dried tomatoes, chopped
225 g cottage cheese
3 large eggs
175 g cheddar cheese, grated
3 tbsp (45 ml) natural yoghurt

Dish: 1 x large Pyrex® gratin dish

1 x medium Pyrex® bowl

Accessory: none

1. Place the prepared vegetables with the garlic and oil in a large Pyrex® gratin dish. Place on the base of the oven and cook on GRILL 1 + LOW MICROWAVE for 30 minutes, turning every 10 mins. Stir in the tomatoes and sun-dried tomatoes. Season to taste.
2. In a medium Pyrex® bowl, beat together the cottage cheese, eggs, cheddar cheese and yoghurt, then season. Pour over the vegetables.
3. Place the large Pyrex® gratin dish on base of the oven and cook on GRILL 1 + LOW MICROWAVE for 7 minutes, then GRILL 1 for a further 3-5 minutes or until golden brown.

Croque monsieur

ingredients

Makes 2

4 slices white bread, buttered
1 tsp (5 ml) Dijon mustard
2 slices smoked ham
100 g cheese, sliced

Dish: none

Accessory: Square Panacrunch Pan

1. Preheat grill on GRILL 1. Place the bread, buttered side up on the Square Panacrunch Pan in the upper shelf position and cook on GRILL 1 for 3-4 minutes or until browning.
2. On 2 slices of the bread, spread the untoasted sides with mustard and top with ham and cheese. Cover with the other slices, browned side uppermost.
3. Place back on the Square Panacrunch Pan in the upper shelf position and cook on GRILL 2 + SIMMER MICROWAVE for 1 minute 30 seconds -2 minutes or until the cheese has melted.

Macaroni cheese

ingredients

Serves 4

200 g quick cook macaroni
40 g butter
1 small onion, finely chopped
100 g bacon, chopped
40 g plain flour
600 ml milk
1 tsp (5 ml) French mustard
150 g cheddar cheese, grated
25 g breadcrumbs

Dish: 1 x 3 litre Pyrex® casserole dish with lid, 1 x 1.5 litre Pyrex® jug, 1 x medium Pyrex® shallow dish

Accessory: Square Panacrunch Pan

1. In a large Pyrex® casserole dish, cook macaroni in 550 ml boiling water. Cover, place on the base of the oven and cook on HIGH MICROWAVE for 5-6 minutes or until soft. Drain.
2. Place butter, onion and bacon in a jug. Place on the base of the oven and cook on HIGH MICROWAVE for 5 minutes or until onion is soft. Stir halfway through cooking.
3. Stir in flour and cook for 30 seconds on HIGH MICROWAVE. Gradually add milk, stir well and season. Cook on HIGH MICROWAVE for 5-6 minutes or until sauce is thick and bubbling. Stir twice during cooking. Add mustard and 100 g grated cheese. Add macaroni and season.
4. Place the macaroni mixture in medium Pyrex® shallow dish. Sprinkle with breadcrumbs and remaining cheese. Place dish on the base of the oven and cook on GRILL 1 + LOW MICROWAVE for 8-10 minutes or until cheese starts to melt.

Cheese, onion & olive scones

ingredients

Serves 4

1 medium onion, finely chopped
2 tsp (10 ml) olive oil
175 g self raising flour
½ tsp (2.5 ml) mustard powder
½ tsp (2.5 ml) salt
1 pinch cayenne pepper
25 g butter
40 g cheddar cheese, grated
40 g parmesan, grated
25 g black olives, chopped
1 egg, beaten
3 tbsp (45 ml) milk
1 egg, beaten to glaze

Dish: 1 x medium Pyrex® bowl

Accessory: Square Panacrunch Pan

1. Place onion and oil in a medium Pyrex® bowl. Place on the base of the oven and cook on HIGH MICROWAVE for 2 minutes or until softened.
2. Preheat oven on OVEN 200 °C.
3. Sift together the flour, salt, mustard and cayenne. Rub in the butter. Mix in onion, cheeses and olives. Beat egg and milk together. Add enough of the egg and milk to form soft dough.
4. On a floured surface roll out dough to approx. 2 cm thick. Cut out rounds using a 5 cm pastry cutter and brush with beaten egg.
5. Line the Square Panacrunch Pan with baking paper. Place the rounds on the Square Panacrunch Pan in the lower shelf position. Cook on OVEN 200 °C for 15-20 minutes or until cooked and golden brown.

Cheese & red pesto tartlets

ingredients

Makes 12

375 g short crust pastry
 90 g red pesto
 1 clove of garlic, crushed
 25 g black olives, stoned and chopped
 125 g mozzarella cheese, grated
 2 medium tomatoes, peeled, seeded and chopped
 25 g parmesan, grated
 1 tsp (5 ml) dried oregano

Dish: 1 x 12 hole cake tin,
 1 x small Pyrex® bowl

Accessory: Square Panacrunch Pan

1. Roll out the short crust pastry to a thickness of approximately 3 mm. Cut out 12 circles using a 7.5 cm pastry cutter. Place in lightly greased cake tin. Chill pastry for 30 minutes.
2. Preheat oven on OVEN 200 °C
3. Mix the red pesto, garlic, black olives, mozzarella and tomatoes together in a small Pyrex® bowl. Fill the tartlet shells with mixture. Sprinkle the parmesan and oregano over the tartlets.
4. Place tin on the Square Panacrunch Pan in the upper shelf position and cook on OVEN 200 °C for 15-20 minutes or until golden brown.

Swiss cheese flan

ingredients

Serves 6

200 g plain flour
 100 g butter
 water to mix
Filling
 250 g Gruyere cheese, grated
 2 tbsp (30 ml) plain flour
 2 eggs, beaten
 300 ml milk
 4 tbsp (60 ml) white wine
 1 clove of garlic, crushed
 1 tsp (5 ml) celery salt
 1 pinch nutmeg

Dish: 1 x medium Pyrex® bowl,
 1 x 22.5 cm flan tin, 1 x small Pyrex®
 bowl, 1 x Pyrex® jug

Accessory: Square Panacrunch Pan

1. In a medium Pyrex® bowl, rub butter into flour until it resembles fine breadcrumbs. Add water to form a dough. Roll out and line dish. Prick base all over with a fork. Chill for 15 minutes.
2. Preheat oven on OVEN 180 °C.
3. Cover pastry with parchment and baking beans. Place on the Square Panacrunch Pan in the lower position and cook on OVEN 180 °C for 20-25 minutes.
4. In a small Pyrex® bowl toss together the grated cheese and flour. Mix remaining ingredients in a jug. Add the cheese and stir well.
5. Pour into flan case and sprinkle with nutmeg. Cook on OVEN 200 °C for 30 minutes or until set and golden brown.

White sauce

ingredients

Makes approx. 500 ml

35 g butter
35 g flour
500 ml milk
salt and pepper
nutmeg

Dish: 1 x medium Pyrex® bowl,
1 x 1.5 litre Pyrex® jug

Accessory: none

1. In a medium Pyrex® bowl, melt the butter for 1 minute, on MEDIUM MICROWAVE on the base of the oven. Add the flour, stir, and cook for a further 1 minute on MEDIUM MICROWAVE. Set aside.
2. Heat the milk in a jug on HIGH MICROWAVE for 2 minutes 30 seconds-3 minutes. Pour the milk over the butter and flour mixture, whisking all the time. Cook again for 5-6 minutes, whisking vigorously several times and paying close attention to ensure that the sauce does not overflow.
3. Check the seasoning and add a pinch of grated nutmeg.

Pepper sauce

ingredients

Serves 4-6

1 onion, chopped
40 g butter
30 g flour
400 ml hot stock, from 2 stock cubes
2 tsp (10 ml) white pepper
1 tsp (5 ml) cognac
200 ml crème fraîche

Dish: 1 x medium Pyrex® bowl

Accessory: none

1. Place the onion and butter in a medium Pyrex® bowl and cook on the base of the oven for 2-3 minutes on HIGH MICROWAVE.
2. Add flour, mix, cook again for 1 minute on HIGH MICROWAVE.
3. Add stock and white pepper. Cook uncovered on HIGH MICROWAVE for 3 minutes. Remove from the oven and add cognac and crème fraîche. Mix well and season with salt before serving.

Custard sauce

ingredients

Makes approx. 300 ml

2 eggs
50 g caster sugar
300 ml milk
1 tsp (5 ml) vanilla essence

Dish: 1 x 1.5 litre Pyrex® jug

Accessory: none

1. Beat eggs with sugar and 3 tbsp (45 ml) milk. Place remaining milk with vanilla essence. Place on the base of the oven and cook on HIGH MICROWAVE for 1 minute.
2. Add milk to eggs and stir well. Cook on LOW MICROWAVE for 5-10 minutes stirring every 30-60 seconds until the sauce coats the back of a spoon.

Steamed jam roly poly pudding

ingredients

Serves 4

100 g suet
175 g self raising flour
cold water, to mix
5 tbs (75 ml) seedless raspberry jam
milk, to glaze

Dish: 1 x medium Pyrex® bowl

Accessory: Square Panacrunch Pan

Fill water tank and refill after 30 minutes cooking

1. Place suet and flour in a medium Pyrex® bowl. Add water and mix to a soft dough.
2. Roll out pastry to approximately 23 x 32 cm. Spread the jam over the pastry leaving 1 cm border all round. Brush the edges with milk and roll the pastry up evenly, starting at one short side and sealing the edges well.
3. Brush top with milk and wrap loosely in baking parchment and place on the Square Panacrunch Pan in the lower shelf position. Cook on STEAM 1 for 45 minutes. Refill the water tank after 30 minutes.

Rice pudding

ingredients

Serves 4

100 g short grain rice
1 litre whole milk
80 g caster sugar
small piece cinnamon stick
1 vanilla pod

Dish: 1 x large Pyrex® bowl

Accessory: none

1. Place the rice, milk and sugar in a large Pyrex® bowl. Add the cinnamon and split vanilla pod. Cover.
2. Bring to the boil by heating on HIGH MICROWAVE for 7-8 minutes on the base of the oven, paying close attention to ensure that the milk does not boil over.
3. Then cook on SIMMER MICROWAVE for 60 minutes. Remove the cinnamon stick and vanilla pod. Leave to cool down.

Steamed vanilla Sponge with custard

ingredients

Serves 6-8

250 g butter, plus extra for greasing
250 g caster sugar
4 eggs, beaten
1 tsp (5 ml) vanilla extract
250 g plain flour
1 tsp (5 ml) baking powder
50 ml whole milk
Custard
250 ml whole milk
2 egg yolks
25 g caster sugar
2 tsp (10 ml) cornflour
few drops vanilla extract

Dish: 1 x medium Pyrex® bowl,

1 x 1.5 litre Pyrex® pudding basin,

1 x 1.5 litre Pyrex® jug

1 x 1.5 litre Pyrex® bowl

Accessory: Square Panacrunch Pan

Fill water tank and refill after every 30 minutes cooking

1. In a medium Pyrex® bowl, make the sponge, cream the butter and the sugar in a mixing bowl until pale and fluffy. Add the eggs, one at a time, mixing well between each addition, then add the vanilla extract. Sift the flour and baking powder into a large Pyrex® bowl and fold into the sponge mixture. Finally, stir the milk into the mixture. Fill a greased pudding basin with the sponge mixture.
2. Place basin on the Square Panacrunch Pan in the lower shelf position on STEAM 1. The sponge pudding will take 1 hour 30 minutes - 2 hours cooking; the oven can only be set to cook for a maximum 30 minutes. at a time. Reset time and fill water tank every 30 minutes.
3. To make the custard, bring the milk to the boil, in a Pyrex® jug. This should take 2 minutes on the base of the oven and cook on HIGH MICROWAVE.
4. In a medium Pyrex® bowl, beat together the yolks, sugar, cornflour and vanilla extract. Pour the hot milk over the egg mix and whisk well. Cook on MEDIUM MICROWAVE for 1 minute, whisk, then cook for another 1 minute, or until thickened. Serve over the sponge.

Sticky pudding with toffee sauce

ingredients

Serves 4

150 g ready to eat dates, stoned and chopped
 50 g butter
 150 g caster sugar
 2 medium eggs, lightly beaten
 150 g self raising flour
 ½ tsp (2.5 ml) nutmeg, grated
 ½ tsp (2.5 ml) ground ginger
Sauce
 150 g muscovado sugar
 75 ml double cream
 75 g butter

Dish: 1 x 2 litre Pyrex® jug,
 1 x large Pyrex® bowl,
 1 x 1.5 litre Pyrex® pudding basin,
Accessory: none

1. In a Pyrex® jug, pour 150 ml boiling water over the chopped dates and set aside to cool.
2. In a large Pyrex® bowl, cream the butter and sugar until light and fluffy. Beat in the eggs a little at a time. Fold in the flour, spices and the dates with the liquid. Pour mixture into pudding basin. Place on the base of the oven and cook on MEDIUM MICROWAVE for 8-10 minutes or until cooked.
3. To make the sauce, place all the ingredients in a large Pyrex® jug. Place on the base of the oven and cook on HIGH MICROWAVE for 1 minute or until the sugar has dissolved. Stir and continue to cook on HIGH MICROWAVE for 1-2 minutes or until smooth and hot.
4. Drizzle the hot sauce over the sponge to serve.

Crème caramel

ingredients

Serves 4

500 ml milk
 1 vanilla pod, split lengthways
 4 eggs, beaten
 50 g caster sugar
Caramel
 50 g caster sugar
 1 tbs (15 ml) water

Dish: 2 x small Pyrex® bowls,
 1 x 3 litre Pyrex® bowl,
 4 x ramekins, 1 x roasting tin 26 X
 18 cm.

Accessory: Square Panacrunch Pan

1. Put the milk and vanilla pod into a small Pyrex® bowl and cook on HIGH MICROWAVE for 5 minutes. Take out of the microwave and leave to infuse for 5 minutes.
2. In a medium Pyrex® bowl, put the eggs and sugar and whisk until thoroughly combined. Discard the vanilla pod and whisk the milk into the egg and sugar mixture.
3. Make the caramel. Put the water and sugar in a small Pyrex® bowl and cook on HIGH MICROWAVE for 2 minutes-2 minutes 30 seconds. WATCH ALL THE TIME. As soon as it turns light golden brown, stop.
4. Pour the caramel into four ramekins. Rotate the moulds quickly so that it coats the sides of the moulds.
5. Preheat the oven on OVEN 150 °C.
6. Strain the custard through a sieve and pour into the moulds and stand them in a small roasting tin half filled with boiling water. Place the tin on the Square Panacrunch Pan in the lower shelf position and cook on OVEN 150 °C for 40 minutes.
7. Chill in the refrigerator before turning out of their moulds.

Coconut tart

ingredients

Serves 8

½ tsp (2.5 ml) ground cinnamon
 175 g desiccated coconut
 225 g caster sugar
 375 g short crust pastry
 1 medium egg, beaten

Dish: 1 x large Pyrex® bowl,
 1 x 23 cm flan dish

Accessory: Square Panacrunch Pan

1. Place cinnamon, coconut and sugar into a large Pyrex® bowl with 150 ml water and cook on the base of the oven on LOW MICROWAVE for 5 minutes, stirring frequently. Set aside to cool.
2. Roll out the pastry on a lightly floured surface and use it to line a 23 cm flan dish. Line the tart with baking paper and fill with baking beans, place on the Square Panacrunch Pan in the lower shelf position and cook on OVEN 180 °C for 15 minutes, remove the baking paper and beans, and continue to bake for 10 minutes. Remove from the oven.
3. Beat the egg into the cooled coconut mixture, then spoon into the pastry case and smooth the top. Place tart on the Square Panacrunch Pan in the lower shelf position, cook on OVEN 180 °C for 18-20 minutes.

Fruit crumble

ingredients

Serves 4

700 g fresh fruit (e.g. apples, plums, rhubarb), peeled and sliced
 sugar to taste
Crumble Topping
 75 g butter
 175 g plain flour
 100 g sugar

Dish: 1 x medium Pyrex® gratin dish,
 1 x medium bowl

Accessory: Square Panacrunch Pan

Fill water tank

1. Layer prepared fruit in the gratin dish. Add sugar to taste, depending on the sharpness of the fruit. Place dish on base of the oven and cook on STEAM 1 + LOW MICROWAVE for 3 minutes.
2. In a medium Pyrex® bowl, rub butter into the flour until mixture resembles fine breadcrumbs. Stir in the sugar. Sprinkle the crumble over the fruit, so that it is completely covered.
3. Place dish on the base of the oven and cook on GRILL 2 + LOW MICROWAVE for 18-20 minutes, or until golden brown.

Red fruit compote

ingredients

Serves 4

200 g plums, halved
 200 g cherries, stoned
 200 g blueberries
 200 g strawberries, halved
 200 g raspberries, halved
 50 g golden caster sugar

Dish: 1 x large Pyrex® shallow dish

Accessory: none

Fill water tank

1. Place the plums, cherries and blueberries in a shallow dish. Place on the base of the oven and cook on STEAM 1 + LOW MICROWAVE for 10 minutes.
2. Stir in the strawberries and cook on STEAM 1 + LOW MICROWAVE for a further 5 minutes.
3. Stir the raspberries and sugar into the hot fruit and allow to cool before serving.

Christmas pudding

ingredients

Serves 6

1 cooking apple, peeled and grated
 1 carrot, peeled and grated
 1 orange, juice and grated rind
 400 g mixed dried fruit
 3 tbsps (45 ml) brandy
 1 tbsp (15 ml) black treacle
 50 g self raising flour
 1 pinch salt
 1 tbsp (15 ml) cocoa powder
 1 tsp (5 ml) mixed spice
 ½ tsp (2.5 ml) nutmeg
 100 g shredded suet
 150 g fresh breadcrumbs
 50 g mixed peel
 50 g flaked almonds
 2 medium eggs, beaten

Dish: 1 x medium Pyrex® bowl,
 1 x 1.5 litre Pyrex® pudding basin

Accessory: None

Fill water tank

1. Place apple and carrot in a medium Pyrex® bowl. Place on the base of the oven and cook on HIGH MICROWAVE for 5 minutes. Beat well to make a thick puree. Stir in orange juice, rind and mixed fruit. Cook on HIGH MICROWAVE for 2 minutes. Stir in brandy and treacle. Stand for 5 minutes. Beat in rest of ingredients.
2. Press into the pudding basin. Place pudding basin on the base of the oven and cook on STEAM 1 + LOW MICROWAVE for 6 minutes. Stand for 5 minutes. Cook on STEAM 1 + LOW MICROWAVE for 14 minutes or until just firm.

NOTE: One of the advantages of using your MICROWAVE to make this traditional pudding is that it can be made the week before Christmas and stored in a cool dry place. Do not attempt to make the pudding earlier than this, since the flavour will not improve with keeping, unlike a traditionally steamed pudding.

Chocolate cheesecake

ingredients

Serves 6-8

100 g butter
 250 g digestive biscuits, crushed
 150 g plain chocolate
 30 ml milk
 450 g cream cheese
 100 g soft brown sugar
 2 large eggs
 1 tsp (5 ml) vanilla essence

Dish: 2 x medium Pyrex® bowl,
 1 x 22.5 cm flan dish

Accessory: Square Panacrunch Pan

1. Place butter in medium Pyrex® bowl on the base of the oven and melt on HIGH MICROWAVE for 40-50 seconds. Stir in biscuits and press into base of flan dish.
2. In a medium Pyrex® bowl, melt chocolate with milk on the base of the oven on MEDIUM MICROWAVE for 1-2 minutes. Leave to cool slightly.
3. Preheat oven on OVEN 150 °C.
4. Mix in all the remaining ingredients and stir in chocolate. Pour over biscuit base. Place flan on the Square Panacrunch Pan in the lower shelf position and cook on OVEN 150 °C for 40-45 minutes. Chill before serving.

Chocolate chunk cookies

ingredients

Serves 12

100 g butter
 100 g caster sugar
 1 egg, beaten
 175 g plain flour
 50 g white chocolate, chopped
 50 g dark chocolate, chopped

Dish: 1 x large Pyrex® bowl

Accessory: Square Panacrunch Pan

1. Preheat oven on OVEN 170 °C.
2. In a large Pyrex® bowl, cream together the butter and sugar until pale, then beat in the egg. Mix in the flour until well combined and add the chocolate.
3. Line the Square Panacrunch Pan with baking paper. Place 6 walnut-sized spoonfuls of dough well apart on the Square Panacrunch Pan, flatten slightly with a fork. Place in the upper shelf position and cook on OVEN 170 °C. for 15-20 minutes. Remove cookies from the Square Panacrunch Pan and allow to cool on a wire rack.
4. Repeat cooking with the remaining dough.

Victoria sandwich

ingredients

Serves 6-8

175 g butter or margarine
175 g caster sugar
3 medium eggs
175 g self raising flour

Dish: 1 x large Pyrex® bowl,
2 x 18 cm round cake tins, greased
and lined

Accessory: Square Panacrunch Pan

Fill water tank

1. In a large Pyrex® bowl, cream butter and sugar until pale and fluffy. Add the eggs a little at a time beating well after each addition. Fold in half the flour, using a metal spoon, then fold in the remaining flour. Spoon the mixture into the tins and level with a knife.
2. Preheat oven on OVEN 180 °C. Place one tin on the Square Panacrunch Pan in the lower position. Cook on OVEN 180 °C for 20 minutes or until cooked. Add STEAM SHOT for 3 minutes 2/3rds of the way through cooking time. Repeat cooking with the second sponge.
3. Sandwich together with cream and jam and dust with icing sugar or with a filling of your choice

Swiss roll

ingredients

Serves 8

3 medium eggs, beaten
125 g caster sugar
125 g plain flour

Filling

jam or cream to fill

Dish: 1 x medium Pyrex® bowl,
1 x 26 cm x 16 cm cake tin, greased
and lined

Accessory: Square Panacrunch Pan

1. Whisk eggs and sugar together in a medium Pyrex® bowl until pale and creamy, and mixture leaves a trail on the surface when the whisk is lifted. Carefully fold in half of the sifted flour, and then fold in the other half. Fold in 15 ml (1 tbsp) of hot water. Pour into the tin, tip the tin to allow mixture to run into corners.
2. Preheat oven on OVEN 200 °C. Place tin on the Square Panacrunch Pan in the lower shelf position and cook on OVEN 200 °C for 10 minutes, or until cooked.
3. Place sheet of greaseproof paper on a damp tea towel and dredge paper with caster sugar. Quickly turn the Swiss roll out onto the greaseproof and carefully remove the baking parchment. Spread with jam or desired filling. Roll up from short side with the aid of the greaseproof paper.

Fruit scones

ingredients

Serves 8

225 g self raising flour
pinch salt
1 tsp (5 ml) baking powder
50 g butter
25 g caster sugar
50 g sultanas
5 tbsp (75 ml) milk
1 medium egg, beaten to glaze

Dish: 1 x large Pyrex® bowl

Accessory: Square Panacrunch Pan

1. In a large Pyrex® bowl, sift the flour, salt and baking powder together. Rub in butter until the mixture resembles fine breadcrumbs. Add sugar and sultanas. Make a well in the centre and stir in enough milk to form a soft dough. Knead lightly. Pat out to 2 cm thick and cut into rounds with a 5 cm cutter.
2. Preheat oven on OVEN 210 °C. Line the Square Panacrunch Pan with a square of greaseproof paper. Place the rounds on the Square Panacrunch Pan and brush with beaten egg. Place the Square Panacrunch Pan in the lower shelf position. Cook on OVEN 210 °C for 12-15 minutes or until cooked and golden brown.

Streusel muffins

ingredients

Makes 6

Streusel topping:

50 g butter
75 g plain flour
2 tbsp (30 ml) granulated sugar
1 tbsp (15 ml) ground mixed spice

Muffins:

200 g plain flour
½ tsp (2.5 ml) bicarbonate of soda
2 tsp (10 ml) baking powder
1 pinch salt
75 g caster sugar
75 g butter
200 ml buttermilk
1 medium egg, beaten
100 g fresh berries

Dish: 2 x small mixing bowl,
1 x large mixing bowl,
1 x 6 hole muffin tin

Accessory: Square Panacrunch Pan

1. Make streusel topping by melting the butter in a small Pyrex® bowl on the base of oven on HIGH MICROWAVE for 10-20 seconds. Add the remaining topping ingredients and combine to make a soft dough. Chill.
2. In a large bowl sift together the flour, bicarbonate, baking powder and salt. Stir in the sugar. In a small Pyrex® bowl, melt butter for the muffins on HIGH MICROWAVE power for 30 seconds-1 minute. Cool slightly then mix in the buttermilk and egg.
3. Lightly stir the buttermilk mixture into the flour mixture. Fold fruit in gently.
4. Preheat oven on OVEN 170 °C.
5. Divide mixture equally between 6 muffin cases. Crumble small amounts of streusel topping over each muffin.
6. Place muffin tin on the Square Panacrunch Pan and cook in the lower shelf position on OVEN 170 °C for 25-30 minutes or until browned and well risen.

Millionaires shortbread

ingredients

Serves 10

Shortbread:

225 g plain flour
75 g caster sugar
175 g butter

Caramel:

200 g butter
397 g condensed milk
4 tbsp (60 ml) golden syrup

Topping:

300 g milk or dark chocolate, broken into small pieces
2 tbsp (30 ml) vegetable oil

Dish: 3 x medium Pyrex® bowls,
1 x 23 x 23 cm cake tin, greased and lined

Accessory: Square Panacrunch Pan

1. For the shortbread, place flour and sugar in a medium Pyrex® bowl and rub in butter. Press dough into the cake tin.
2. Preheat oven on OVEN 170 °C. Prick shortbread with a fork and cook on the Square Panacrunch Pan in the lower shelf position on OVEN 170 °C for 5 minutes, then reduce temperature to 150 °C for 30-40 minutes. Remove from oven when shortbread has a golden colour and leave to cool in tin. Remove Square Panacrunch Pan.
3. Place butter for caramel in a medium Pyrex® bowl. Place on the base of the oven and melt on HIGH MICROWAVE for 1-2 minutes. Add condensed milk and syrup. Whisk until thoroughly mixed and cook on HIGH MICROWAVE for 5-10 minutes. Stir mixture every minute to prevent burning. Caramel should have thickened, allow to cool slightly. Pour caramel over shortbread and chill.
4. Place chocolate and oil in a medium Pyrex® bowl and melt on HIGH MICROWAVE for 1-2 minutes. Stir, allow to cool slightly. Pour chocolate over caramel and chill.

Bread rolls

ingredients

Makes approx. 6-8 rolls

450 g strong bread flour
1 sachet dried yeast
1 tsp (5 ml) salt
15 g butter or margarine
275 ml warm water

For Wholemeal Bread:

use 225 g each of wholemeal and strong white bread flour

For Granary Bread:

use 450 g granary flour instead of strong white bread flour

Dish: 1 x large Pyrex® bowl

Accessory: Square Panacrunch Pan

Fill water tank

1. In a large Pyrex® bowl, combine the flour, yeast and salt. Rub in the butter or margarine. Add the warm water then mix to a dough. Turn onto a floured surface and knead for 10 minutes.
2. Divide the dough into 8 and shape into rolls. Place the rolls on the Square Panacrunch Pan lined with baking paper.
3. Cover with cling film and prove until the dough has doubled in size in a warm place or place in the oven to prove on OVEN 40 °C in the lower shelf position for 40 minutes.
4. Preheat on OVEN 200 °C. Glaze bread rolls with beaten egg and sprinkle with seeds, if desired. Place the Square Panacrunch Pan in the lower shelf position and cook on OVEN 200 °C for 25-30 minutes with a STEAM SHOT for 3 minutes 2/3 rds of the way through the cooking time.

Pizza

ingredients

Serves 2-4

2 onions, finely sliced
3 cloves of garlic, crushed
1 tbsp (15 ml) olive oil
1 roll pizza dough
100 g passata
2 tsp (10 ml) oregano
100 g mozzarella, grated

Dish: 1 x large Pyrex® bowl

Accessory: Square Panacrunch Pan

Fill water tank

1. Place the finely sliced onions and garlic in a large Pyrex® bowl, with the olive oil. Cook on the base of the oven for 5 minutes on HIGH MICROWAVE. Leave to cool.
2. Line the Square Panacrunch Pan with baking paper. Using your hands, spread out the dough in the Square Panacrunch Pan without making a raised edge.
3. Spread on the sauce, onions, oregano and season, covering all the dough well.
4. Preheat the oven on OVEN 220 °C. Cook on OVEN 220 °C for 15-20 minutes.
5. Add the cheese, and continue cooking on OVEN 220 °C for 8-10 minutes with a STEAM SHOT for 3 minutes at the start of this cooking stage.

Focaccia

ingredients

Makes 1 loaf

400 g strong bread flour
 1 sachet dried yeast
 2 tsp (10 ml) salt
 75 g olive oil
 2 tsp (10 ml) course sea salt

Dish: 2 x large Pyrex® bowl,
 1 x 25 cm round tin

Accessory: Square Panacrunch Pan

Fill water tank

1. In a large Pyrex® bowl, combine the flour, yeast and salt. Gradually add the olive oil and 5-10 tbsp of warm water until you have soft dough. Turn onto a floured surface and knead for 10 minutes.
2. Place in a large Pyrex® greased bowl, cover and prove until the dough has doubled in size in a warm place or on OVEN 40 °C. Knock back the dough and knead again for a few minutes.
3. Press the dough into a greased 25 cm round tin, cover and prove in a warm place or on OVEN 40 °C for approximately 30 minutes.
4. Preheat on OVEN 190 °C. Dimple the surface of the dough. Drizzle with a little extra olive oil and sprinkle with course sea salt. Cook on the Square Panacrunch Pan on OVEN 190 °C for 30 minutes with a STEAM SHOT for 3 minutes 2/3rds of the way through cooking time. Carefully remove from the tin and leave to cool on a wire rack.

Sun dried tomato rolls

ingredients

Makes 6 rolls

250 g strong white flour
 1 sachet dried yeast
 1 tsp (5 ml) salt
 25 g sun dried tomatoes, roughly chopped
 45 ml olive oil
 75 ml passata
 75 ml warm water
 1 tsp (5 ml) olive oil

Dish: 1 x large Pyrex® bowl

Accessory: Square Panacrunch Pan

1. In a large Pyrex® bowl, combine the flour, yeast and salt, stir in the tomatoes. Gradually add the olive oil, passata and 3-5 tbsp of warm water until you have soft dough. Turn onto a floured surface and knead for 10 minutes.
2. Line the Square Panacrunch Pan with baking paper. Divide dough into 6 and place on the Square Panacrunch Pan. Prove until dough has doubled in size in a warm place or on OVEN 40 °C for approximately 40 minutes.
3. Preheat on OVEN 220 °C. Drizzle with a little extra olive oil and sprinkle with course sea salt. Cook on OVEN 220 °C for 15-20 minutes or until golden.

Guidelines

Making jams, marmalades and chutneys by microwave is much quicker and cleaner than using a large pan on the hob. One of the main advantages is that preserves can be made in small batches, using fresh or frozen fruit exactly when it suits you.

Dish size

Always use a very large glass bowl. DO NOT attempt to use jam pans or saucepans in your microwave.

Covering

Do not cover preserves whilst cooking.

Sterilising jars

Jam jars can be sterilised by microwave ready for your jams. Half fill with water and heat them on HIGH MICROWAVE until water boils (approx. 3 min. for 2 jars). Empty

and drain upside down on kitchen paper. The jars should be warm when filled with jam.

Do not use your microwave to Sterilise babies' bottles.

Do not seal preserving jars in your microwave.

Stirring

Keep a wooden spoon handy for stirring the jams/preserves, but DO NOT leave the spoon in the oven whilst cooking.

Setting point

Place a couple of drops of jam or marmalade on a cold saucer (put one in the fridge whilst making the jam). Leave to cool. The jam should wrinkle on the surface when your finger pushes across the top.

Plum jam

ingredients

Makes approx. 1.5 kg

675 g plums or damsons
200 ml water
675 g jam sugar
2 tbsp (30 ml) lemon juice
1 tsp (5 ml) butter

Dish: 1 x 2 litre Pyrex® bowl

Accessory: none

1. Prick the plums and place in a large Pyrex® bowl with the water. Place on base of oven and cook on MEDIUM MICROWAVE for 10 minutes or until the fruit is soft.
2. Add the rest of the ingredients and cook on HIGH MICROWAVE for 5 minutes stirring frequently. Wash down any sugar crystals from around the bowl and bring to the boil on HIGH MICROWAVE.
3. Continue to cook on HIGH MICROWAVE until setting point is reached - approx. 25-30 minutes.
4. Leave to cool slightly, remove the stones, then pot, seal and label.

Tomato chutney

ingredients

Makes approx. 1 kg

700 g tomatoes
225 g cooking apples, peeled and chopped
1 medium onion, roughly chopped
100 g granulated sugar
2 tbsp (30 ml) tomato puree
1 tsp (5 ml) salt
200 ml white wine vinegar
2 tsp (10 ml) ground ginger
¼ tsp (1.25 ml) cayenne pepper
½ tsp (2.5 ml) mustard powder

Dish: 1 x medium Pyrex® bowl,

1 x large Pyrex® casserole dish with lid

Accessory: none

1. Prick the tomatoes and place in a medium Pyrex® bowl. Cover with boiling water and leave for 5 minutes. Drain. Peel off skin and roughly chop flesh.
2. Blend apple and onion in a food processor to a thick puree. Combine all ingredients together in a bowl.
3. Cover, place on the base of the oven and cook on HIGH MICROWAVE for 25-30 minutes. Stirring occasionally, or until the mixture is thick with no excess liquid.
4. Leave to stand for 10 minutes then stir and pour into sterilised jars. Allow to cool thoroughly before chilling

Red onion chutney

ingredients

Makes approx. 750 g

3 tbsp (45 ml) olive oil
 4 large red onions, halved and thinly sliced
 50 g demerara sugar
 100 g sultanas
 300 ml red wine
 125 ml red wine vinegar

Dish: 1 x large Pyrex® casserole dish with lid

Accessory: none

1. Put oil in a large Pyrex® bowl with onions. Place on the base of the oven and cook covered on MEDIUM MICROWAVE for 10 minutes stirring halfway.
2. Add all other ingredients and mix well. Cover and cook on MEDIUM MICROWAVE for 30-35 minutes. Cool slightly, then pour into a clean, sterilised jar. Allow to cool thoroughly before chilling.

Soft fruit jam

ingredients

Makes 2 jars

450 g soft fruit, washed
 250 g jam sugar
 200 g granulated sugar
 ½ tsp (2.5 ml) lemon juice
 1 tsp (5 ml) butter

Dish: 1 x 2 litre Pyrex® bowl

Accessory: none

1. Place all ingredients in a large Pyrex® bowl. Place on the base of the oven and cook on HIGH MICROWAVE for 5 minutes. (10-15 minutes if using frozen fruit). Stir occasionally. Continue to cook until sugar has dissolved. Wash down any sugar crystals from around the bowl.
2. Bring mixture to the boil on HIGH MICROWAVE. Continue to cook until setting point is reached - approx. 15-20 minutes.
3. Leave to cool slightly, stir then pot, seal and label.

Lemon curd

ingredients

Makes 2 jars

4 unwaxed lemons, zest and juice
 400 g granulated sugar
 4 medium eggs, beaten
 100 g butter

Dish: 1 x large Pyrex® bowl

Accessory: none

1. Place all the ingredients in a large Pyrex® bowl and mix together well. Place on the base of the oven and cook on HIGH MICROWAVE for 5-6 minutes, stirring every minute to begin with then every 30 seconds once the mixture starts to thicken. When the mixture stays on the back of the spoon, stop cooking, before the eggs cook too much. The mixture will continue to thicken as it cools.
2. Fill the jars while the curd is hot, close them and turn them over. Keep the lemon curd in the fridge.

Questions and Answers

Q: Why won't my oven turn on?

A: When the oven does not turn on, check the following:

1. Is the oven plugged in securely? Remove the plug from the outlet, wait 10 seconds and reinsert.
2. Check the circuit breaker and the fuse. Reset the circuit breaker or replace the fuse if it is tripped or blown.
3. If the circuit breaker or fuse is all right, plug another appliance into the outlet. If the other appliance works, there probably is a problem with the oven. If the other appliance does not work, there probably is a problem with the outlet.

If it seems that there is a problem with the oven, contact an authorised Service Centre.

Q: My oven causes interference with my TV. Is this normal?

A: Some radio, TV, Wi-Fi, cordless telephone, baby monitor, blue tooth or other wireless equipment interference might occur when you cook with the microwave oven. This interference is similar to the interference caused by small appliances such as mixers, vacuums, blow dryers, etc. It does not indicate a problem with your oven.

Q: The oven won't accept my program. Why?

A: The oven is designed not to accept an incorrect program. For example, the oven will not accept a fourth stage.

Q: Sometimes warm air comes from the oven vents. Why?

A: The heat given off from the cooking food warms the air in the oven cavity. This warmed air is carried out of the oven by the air flow pattern in the oven. There are no microwaves in the air. The oven vents should never be blocked during cooking.

Q: I can't set an auto cook program and 'HOT' appears in the display. Why?

A: If 'HOT' appears in the display window, the oven temperature is too high from previous use and an auto program can not be set. Cooking mode and time may still be set manually.

Q: Can I use a conventional oven thermometer in the oven?

A: Only when you are using **grill/oven** cooking modes. The metal in some thermometers may cause arcing in your oven and should not be used on **microwave** and **combination** cooking modes.

Q: There are humming and clicking noises from my oven when I cook by **combination**. What is causing these noises?

A: The noises occur as the oven automatically switches from **microwave** power to **grill/oven** to create the combination setting. This is normal.

Q: My oven has an odour and generates smoke when using the **combination, oven** and **grill** function. Why?

A: After repeated use, it is recommended to clean the oven and then run the oven without food. This will burn off any food, residue or oil which may cause an odour and/or smoking.

Questions and Answers

- Q: The oven stops cooking by microwave and 'H97' or 'H98' appears in the display. Why?
- A: This display indicates a problem with the microwave generation system. Please contact an authorised Service Centre.
- Q: The fan continues to rotate after cooking. Why?
- A: After using the oven, the fan motor may rotate to cool the electrical components. This is normal and you can continue using the oven at this time.
- Q: Can I check the pre-set oven temperature while cooking or preheating by **oven**?
- A: Yes. Touch **oven** and the oven temperature will appear in the display window for 2 seconds.
- Q: "DEMO MODE PRESS ANY KEY" appears in the display and the oven does not cook. Why?
- A: The oven has been programmed in **demo mode**. This mode is designed for retail store display. Deactivate this mode by touch Micro Power once and Stop/Cancel 4 times.
- Q: The operation guide has disappeared on my display, I can only see numbers. Why?
- A: The operation guide was turned off by tapping Timer/Clock 4 times. When colon or time of day is displayed, touch Timer/Clock 4 times to turn the operation guide back on.
- Q: The oven stops cooking by steam or combination with steam and U14 appears in the display.
- A: The water tank is empty and the operation guide has been turned off. Re-fill the water tank, position back in the oven and touch Start to resume cooking. If this happens 3 times during operation, cooking will stop. Press Stop/Cancel to reset.
- Q: The control panel keys do not respond when tapped. Why?
- A: Ensure the oven is plugged in. The oven may be in stand-by mode. Open and close the door to activate.

Specifications

Manufacturer		Panasonic
Model		NN-DS596B BPQ
Power Supply		230-240 V 50 Hz
Operating Frequency:		2450 MHz
Input Power:	Maximum	2010 W
	Microwave	1000 W
	Grill	1220 W
	Oven	1270 W
	Steam	1020 W
Output Power:	Microwave	1000 W (IEC-60705)
	Grill	1200 W
	Oven	1250 W
Grill Heater Top		1200 W
External Dimensions		512 mm (W) x 400 mm (D) x 347 mm (H)
Interior Dimensions W x D x H (mm)		335 mm (W) x 350 mm (D) x 238 mm (H)
Uncrated Weight (approx.)		16.4 kg
Noise		56 dB

Weight and Dimensions shown are approximate.

This product is an equipment that fulfills the European standard for EMC disturbances (EMC = Electromagnetic Compatibility) EN 55011. According to this standard this product is an equipment of group 2, class B and is within required limits. Group 2 means that radio-frequency energy is intentionally generated in the form of electromagnetic radiation for purpose of warming or cooking food. Class B means that this product may be used in normal household areas.

Manufactured by: Panasonic Appliances Microwave Oven (Shanghai) Co., Ltd.
888, 898 Longdong Road. Pudong, Shanghai, 201203, China.

Imported by: Panasonic Marketing Europe GmbH

REP. EU: Panasonic Testing Centre
Winsbergring 15, 22525 Hamburg, Germany



Visit Panasonic's **The Ideas Kitchen** website for Microwave advice, recipes, cooking tips and offers:

www.theideaskitchen.co.uk



learn



cook



share

PHONE OUR CUSTOMER COMMUNICATIONS CENTRE

0344 344 3899

For service or spares.

**Or order spares direct on line at
www.panasonic.co.uk**

Panasonic Manufacturing U.K. Ltd.
<http://www.panasonic.com>

© Panasonic Corporation 2016

F0003BU00BP
PA0316-0
Printed in P.R.C.