



Washing Machine

User manual

WD13J7****

SAMSUNG

Content

Safety information	4
What you need to know about the safety instructions	4
Important safety symbols	4
Important safety precautions	5
To minimize the risk of fire in a tumble dryer, the following should be observed	8
Critical installation warnings	10
Installation cautions	11
Critical usage warnings	12
Usage cautions	13
Critical cleaning warnings	17
Installation	18
What's included	18
Installation requirements	20
Step-by-step installation	22
Environment	30
Before you start	31
Initial settings	31
Laundry guidelines	32
Detergent drawer guidelines	34
Operations	36
Control panel	36
Simple steps to start	37
Cycle overview	39
Special features	42
Settings	45

Maintenance	47
Drum clean	47
Smart Check	48
Emergency drain	49
Cleaning	50
Recovery from freezing	55
Care against an extended time of disuse	55
Troubleshooting	56
Checkpoints	56
Information codes	60
Specifications	63
Fabric care chart	63
Protecting the environment	64
Specification sheet	65



Safety information

Congratulations on your new Samsung washing machine. This manual contains important information on the installation, use and care of your appliance. Please take some time to read this manual to take full advantage of your washing machine's many benefits and features.

What you need to know about the safety instructions

Please read this manual thoroughly to ensure that you know how to safely and efficiently operate the extensive features and functions of your new appliance. Please store the manual in a safe location close to the appliance for future reference. Use this appliance only for its intended purpose as described in this instruction manual.

Warnings and Important Safety Instructions in this manual do not cover all possible conditions and situations that may occur. It is your responsibility to use common sense, caution and care when installing, maintaining and operating your washing machine.

Because the following operating instructions cover various models, the characteristics of your washing machine may differ slightly from those described in this manual and not all warning signs may be applicable. If you have any questions or concerns, contact your nearest service centre or find help and information online at www.samsung.com.

Important safety symbols

What the icons and signs in this user manual mean:

 **WARNING**

Hazards or unsafe practices that may result in severe personal injury, death and/or property damage.

 **CAUTION**

Hazards or unsafe practices that may result in personal injury and/or property damage.

 **CAUTION**

To reduce the risk of fire or explosion, follow these basic precautions.

 **NOTE**

Indicates that a risk of personal injury or material damage exists.

 **Read the instructions**



These warning signs are here to prevent injury to yourself and others. Please follow them explicitly.

Please follow them explicitly.

After reading this manual, store it in a safe place for future reference.

Read all instructions before using the appliance.

As with any equipment that uses electricity and moving parts, potential hazards exist. To safely operate this appliance, familiarize yourself with its operation and exercise care when using it.

Important safety precautions

WARNING

To reduce the risk of fire, electric shock, or injury to persons when using your appliance, follow basic precautions, including the following:

1. This appliance is not intended for use by persons (including children) with reduced physical, sensory or mental capabilities, or lack of experience and knowledge, unless they have been given supervision or instruction concerning use of the appliance by a person responsible for their safety.
2. **For use in Europe:** This appliance can be used by children aged from 8 years and above and persons with reduced physical, sensory or mental capabilities or lack of experience and knowledge if they have been given supervision or instruction concerning use of the appliance in a safe way and understand the hazards involved. Children shall not play with the appliance. Cleaning and user maintenance shall not be made by children without supervision.
3. Children should be supervised to ensure that they do not play with the appliance.

Safety information

4. If the supply cord is damaged, it must be replaced by the manufacturer, its service agent or similarly qualified persons in order to avoid a hazard.
5. The new hose-sets supplied with the appliance are to be used and that old hose-sets should not be reused.
6. For appliances with ventilation openings in the base, that a carpet must not obstruct the openings;
7. **For use in Europe:** Children of less than 3 years should be kept away unless continuously supervised.
8. **CAUTION:** In order to avoid a hazard due to inadvertent resetting of the thermal cut-out, this appliance must not be supplied through an external switching device, such as a timer, or connected to a circuit that is regularly switched on and off by the utility.
9. The tumble dryer is not to be used if industrial chemicals have been used for cleaning.
10. The lint trap has to be cleaned frequently, if applicable.
11. Lint must not be allowed to accumulate around the tumble dryer. (not applicable for appliances intended to be vented to the exterior of the building)
12. Adequate ventilation has to be provided to avoid the back flow of gases into the room from appliances burning other fuels, including open fires.
13. Do not dry unwashed items in the tumble dryer.

-
14. Items that have been soiled with substances such as cooking oil, acetone, alcohol, petrol, kerosene, spot removers, turpentine, waxes and wax removers should be washed in hot water with an extra amount of detergent before being dried in the tumble dryer.
 15. Items such as foam rubber (latex foam), shower caps, waterproof textiles, rubber backed articles and clothes or pillows fitted with foam rubber pads should not be dried in the tumble dryer.
 16. Fabric softeners, or similar products, should be used as specified by the fabric softener instructions.
 17. The final part of a tumble dryer cycle occurs without heat (cool down cycle) to ensure that the items are left at a temperature that ensures that the items will not be damaged.
 18. Remove all objects from pockets such as lighters and matches.
 19. **WARNING:** Never stop a tumble dryer before the end of the drying cycle unless all items are quickly removed and spread out so that the heat is dissipated.
 20. Exhaust air must not be discharged into a flue which is used for exhausting fumes from appliances burning gas or other fuels.
 21. The appliance must not be installed behind a lockable door, a sliding door or a door with a hinge on the opposite side to that of the tumble dryer, in such a way that a full opening of the tumble dryer door is restricted.
 22. **WARNING:** The appliance must not be supplied through an external switching device, such as a timer, or connected to a circuit that is regularly switched on and off by a utility.

Safety information

To minimize the risk of fire in a tumble dryer, the following should be observed

CAUTION

Items that have been spotted or soaked with vegetable or cooking oil constitute a fire hazard and should not be placed in a tumble dryer. Oil-affected items can ignite spontaneously, especially when exposed to heat sources such as in a tumble dryer. The items become warm, causing an oxidation reaction in the oil. Oxidation creates heat. If the heat cannot escape, the items can become hot enough to catch fire. Piling, stacking or storing oil-affected items can prevent heat from escaping and so create a fire hazard. If it is unavoidable that fabrics that contain vegetable or cooking oil or have been contaminated by hair care products be placed in a tumble dryer they should first be washed in hot water with extra detergent - this will reduce, but not eliminate, the hazard. The 'cool down' cycle of tumble dryers should be used to reduce the temperature of the items. They should not be removed from the tumble dryer or piled or stacked while hot.

Items that have been previously cleaned in, washed in, soaked in or spotted with petrol/gasoline, dry-cleaning solvents or other flammable or explosive substances should not be placed in a tumble dryer. Highly flammable substances commonly used in domestic environments include acetone, denatured alcohol, petrol/gasoline, kerosene, spot removers(some brands), turpentine, waxes and wax removers.

Items containing foam rubber(also known as latex foam) or similarly textured rubber. Like materials should not be dried in a tumble dryer on a heat setting. Foam rubber materials can, when heated, produce fire by spontaneous combustion.

Fabric softeners or similar products should not be used in a tumble dryer to eliminate the effects of static electricity unless this practice is specifically recommended by the manufacturer of the fabric softener or product.

Undergarments that contain metal reinforcements should not be placed in a tumble dryer. Damage to the tumble dryer can result if metal reinforcements come loose during drying. When available a drying rack could be used for such items.

Plastic articles such as shower caps or babies' waterproof napkin covers should not be placed in a tumble dryer.

Rubber-backed articles, clothes fitted with foam rubber pads, pillows, galoshes and rubber-coated tennis shoes should not be placed in a tumble dryer.

Do not dry unwashed items in the tumble dryer(or washing machine drying mode,etc).

Items that have been soiled with substances such as cooking oil, acetone, alcohol, petrol, Kerosene, spot removers, turpentine, waxes and wax removers should be washed in hot water with an extra amount of detergent before being dried in the tumble dryer.

Items such as foam rubber(latex foam), shower caps, waterproof textiles, rubber backed articles and clothes or pillows fitted with foam rubber pads should not be dried in the tumble dryer.

Fabric softeners, or similar products, should be used as specified by the fabric softener instructions.

The final part of a tumble dryer cycle occurs without heat(cool down cycle) to ensure that the items are left at a temperature that ensures that the items will not be damaged.

Oil-affected items can ignite spontaneously, especially when exposed to heat sources such as in a tumble dryer. The items become warm, causing an oxidation reaction in the oil. Oxidation creates heat. If the heat cannot escape, the items can become hot enough to catch fire. Piling, stacking or storing oil-affected items can prevent heat from escaping and so create a fire hazard.

If it is unavoidable that fabrics that contain vegetable or cooking oil or have been contaminated by hair care products be placed in a tumble dryer they should first be washed in hot water with extra detergent - this will reduce, but not eliminate, the hazard.

Never stop a tumble dryer before the end of the drying cycle unless all items are quickly removed and spread out so that the heat is dissipated.

Remove all objects from pockets such as lighters and matches.

The tumble dryer(or washing machine drying mode, etc) is not to be used if industrial chemicals have been used for cleaning.



Safety information

Critical installation warnings

WARNING

The installation of this appliance must be performed by a qualified technician or service company.

- Failure to do so may result in electric shock, fire, an explosion, problems with the product, or injury.

The appliance is heavy, therefore take care when lifting it.

Plug the power cord into a wall socket that meets local electrical specifications. Use the socket for this appliance only, and do not use an extension cord.

- Sharing a wall socket with other appliances using a power strip or extending the power cord may result in electric shock or fire.
- Ensure that the power voltage, frequency, and current are the same as those of the product specifications. Failure to do so may result in electric shock or fire. Plug the power plug into the wall socket firmly.

Remove all foreign substances such as dust or water from the power plug terminals and contact points using a dry cloth on a regular basis.

- Unplug the power plug and clean it with a dry cloth.
- Failure to do so may result in electric shock or fire.
- Plug the power plug into the wall socket so that the cord is running towards the floor. If you plug the power plug into the socket in the opposite direction, the electric wires within the cable may be damaged and this may result in electric shock or fire.

Keep all packaging materials out of the reach of children as these may be dangerous.

- If a child places a bag over its head, it may suffocate. When the appliance, power plug or power cord is damaged, contact your nearest service centre.

This appliance must be properly grounded.

Do not ground the appliance to a gas pipe, plastic water pipe, or telephone line.

- This may result in electric shock, fire, an explosion, or problems with the product.
- Never plug the power cord into a socket that is not grounded correctly and make sure that it is in accordance with local and national regulations.

Do not install this appliance near a heater or any inflammable material.

Do not install this appliance in a humid, oily or dusty location, or in a location exposed to direct sunlight or water (rain drops).

Do not install this appliance in a location exposed to low temperatures.

- Frost may cause the tubes to burst.



Do not install this appliance in a location where gas may leak.

- This may result in electric shock or fire.

Do not use an electric transformer.

- This may result in electric shock or fire.

Do not use a damaged power plug, damaged power cord, or loose wall socket.

- This may result in electric shock or fire.

Do not pull or excessively bend the power cord.

Do not twist or tie the power cord.

Do not hook the power cord over a metal object, place a heavy object on the power cord, insert the power cord between objects, or push the power cord into the space behind the appliance.

- This may result in electric shock or fire.

Do not pull the power cord when unplugging the power plug.

- Unplug the power plug by holding the plug.
- Failure to do so may result in electric shock or fire.

This appliance should be positioned so that the power plug, the water supply taps, and the drain pipes are accessible.

Installation cautions

CAUTION

This appliance should be positioned in such a way that the power plug is easily accessible.

- Failure to do so may result in electric shock or fire due to electric leakage.

Install your appliance on a solid, level floor that can support its weight.

- Failure to do so may result in abnormal vibrations, movement, noise, or problems with the product.



Safety information

Critical usage warnings

WARNING

If the appliance is flooded, turn off the water & power supplies immediately and contact your nearest service centre.

- Do not touch the power plug with wet hands.
- Failure to do so may result in electric shock.

If the appliance generates a strange noise, a burning smell, or smoke, unplug the power plug immediately and contact your nearest service centre.

- Failure to do so may result in electric shock or fire.

In the event of a gas leak (such as propane gas, LP gas, etc.), ventilate immediately without touching the power plug. Do not touch the appliance or power cord.

- Do not use a ventilating fan.
- A spark may result in an explosion or fire.

Do not let children play in or on the washing machine. In addition, when disposing of the appliance, remove the washing machine door lever.

- If trapped inside the product, children may suffocate to death.

Make sure to remove the packaging (sponge, styrofoam) attached to the bottom of the washing machine before using it.

Do not wash items contaminated with gasoline, kerosene, benzene, paint thinner, alcohol or other inflammable or explosive substances.

- This may result in electric shock, fire, or an explosion.

Do not open the washing machine door by force while it is operating (high-temperature washing/drying/spinning).

- Water flowing out of the washing machine may result in burns or cause the floor to be slippery. This may result in injury.
- Opening the door by force may result in damage to the product or injury.

Do not insert your hand under the washing machine while an operation is in progress.

- This may result in injury.

Do not touch the power plug with wet hands.

- This may result in electric shock.

Do not turn the appliance off by unplugging the power plug while an operation is in progress.

- Plugging the power plug into the wall socket again may cause a spark and result in electric shock or fire.



Do not let children or the infirm use this washing machine without proper supervision. Do not let children climb in or onto the appliance.

- This may result in electric shock, burns or injury.

Do not insert your hand or a metal object under the washing machine while it is operating.

- This may result in injury.

Do not unplug the appliance by pulling the power cord. Always grip the plug firmly and pull it straight out of the outlet.

- Damage to the power cord may cause a short-circuit, fire and/or electric shock.

Do not attempt to repair, disassemble, or modify the appliance yourself.

- Do not use a fuse (such as copper, steel wire, etc.) other than a standard fuse.
- When the appliance needs to be repaired or reinstalled, contact your nearest service centre.
- Failure to do so may result in electric shock, fire, problems with the product, or injury.

If the water supply hose comes loose from the water tap and floods the appliance, unplug the power plug.

- Failure to do so may result in electric shock or fire.

Unplug the power plug when the appliance is not being used for long periods of time or during a thunder or lightning storm.

- Failure to do so may result in electric shock or fire.

If any foreign substance enters into the appliance, unplug the power plug and contact your nearest Samsung Customer Service.

- This may result in electric shock or fire.

Do not let children (or pets) play in or on your washing machine. The washing machine door does not open easily from the inside and children may be seriously injured if trapped inside.

Usage cautions

CAUTION

When the washing machine is contaminated by a foreign substance such as detergent, dirt, food waste, etc., unplug the power plug and clean the washing machine using a damp, soft cloth.

- Failure to do so may result in discolouration, deformation, damage, or rust.

The front glass may be broken by a strong impact. Take care when using the washing machine.



Safety information

- If the glass is broken, it may result in injury.

After a water supply failure or when reconnecting the water supply hose, open the water tap slowly.

Open the water tap slowly after a long period of non-use.

- The air pressure in the water supply hose or the water pipe may damage a product part or result in a water leak.

If a draining error occurs during an operation, check if there is a draining problem.

- If the washing machine is used when it is flooded because of a draining problem, it may result in electric shock or fire.

Insert the laundry into the washing machine completely so that the laundry does not get caught in the door.

- If laundry gets caught in the door, it may result in damage to the laundry or the washing machine, or result in a water leak.

Turn the water supply off when the washing machine is not being used.

- Ensure that the screws on the water supply hose connector are properly tightened.

Ensure that the rubber seal and front door glass are not contaminated by a foreign substance (e.g. waste, thread, hair, etc.).

- If a foreign substance is caught in the door or the door is not completely closed, it may cause a water leak.

Open the water tap and check if the water supply hose connector is firmly tightened and that there is no water leak before using the product.

- If the screws on the water supply hose connector are loose, it may result in a water leak.

The product you have purchased is designed for domestic use only.

Using the product for business purposes qualifies as a product misuse. In this case, the product will not be covered by the standard warranty provided by Samsung and no responsibility can be attributed to Samsung for malfunctions or damages resulting from such misuse.

Do not stand on the appliance or place objects (such as laundry, lighted candles, lighted cigarettes, dishes, chemicals, metal objects, etc.) on the appliance.

- This may result in electric shock, fire, problems with the product, or injury.

Do not spray volatile material such as insecticide onto the surface of the appliance.

- As well as being harmful to humans, this may result in electric shock, fire or problems with the product.



Do not place objects that generate electromagnetic fields near the washing machine.

- This may result in injury due to a malfunction.

Water drained during a high-temperature wash or drying cycle is hot. Do not touch the water.

- This may result in burns or injury.

Do not wash, spin, or dry water-proof seats, mats, or clothing (*) unless your appliance has a special cycle for washing these items.

(*): Woollen bedding, rain covers, fishing vests, ski pants, sleeping bags, diaper covers, sweat suits, and bicycle, motor cycle and car covers, etc.

- Do not wash thick or hard mats even if the washing machine mark is on the care label. This may result in injury or damage to the washing machine, walls, floor, or clothing due to abnormal vibrations.
- Do not wash throw rugs or doormats with rubber backing. The rubber backing may come off and stick to inside the drum, and this may result in malfunction such as a drainage error.

Do not operate the washing machine when the detergent drawer is removed.

- This may result in electric shock or injury due to a water leak.

Do not touch the insides of the drum during or just after drying as it is hot.

- This may result in burns.

Do not insert your hand into the detergent drawer.

- This may result in injury as your hand may be caught by the detergent input device.
- The liquid detergent guide (applicable models only) is not used for powder detergent. Remove the guide when using powder detergent.

Do not place any objects (such as shoes, food waste, animals) other than laundry into the washing machine.

- This may result in damage to the washing machine, or injury and death in the case of pets due to the abnormal vibrations.

Do not press the buttons using sharp objects such as pins, knives, fingernails, etc.

- This may result in electric shock or injury.

Do not wash laundry contaminated by oils, creams or lotions usually found in skincare shops or massage clinics.

- This may cause the rubber seal to become deformed and result in a water leak.

Do not leave metal objects such as safety pins, hair pins or bleach in the drum for long periods of time.

- This may cause the drum to rust.



Safety information

- If rust starts appearing on the surface of the drum, apply a (neutral) cleansing agent to the surface and use a sponge to clean it. Never use a metal brush.

Do not use dry cleaning detergent directly and do not wash, rinse, or spin laundry contaminated by dry cleaning detergent.

- This may result in spontaneous combustion or ignition due to the heat from the oxidation of the oil.

Do not use water from water cooling/heating devices.

- This may result in problems with the washing machine.

Do not use natural hand-washing soap for the washing machine.

- If it hardens and accumulates inside the washing machine, it may result in problems with the product, discolouration, rust, or bad odours.

Place socks and brassieres in a washing net and wash them with the other laundry.

Do not wash large laundry items such as bedding in the washing net.

- Failure to do so may result in injury due to abnormal vibrations.

Do not use hardened detergent.

- If it accumulates inside the washing machine, it may result in a water leak.

Make sure that the pockets of all the clothing items to be washed are empty.

- Hard, sharp objects such as coins, safety pins, nails, screws, or stones can cause extensive damage to the appliance.

Do not wash clothing with large buckles, buttons or other heavy metal objects.

Sort the laundry by color on the basis of its colorfastness and select the recommended cycle, water temperature and additional functions.

- This may result in discoloration or fabric damage.

Take care that children's fingers are not caught in the door when you close it.

- Failure to do so may result in injury.



Critical cleaning warnings

WARNING

Do not clean the appliance by spraying water directly onto it.

Do not use a strong acidic cleaning agent.

Do not use benzene, thinner or alcohol to clean the appliance.

- This may result in discolouration, deformation, damage, electric shock or fire.

Before cleaning or performing maintenance, unplug the appliance from the wall socket.

- Failure to do so may result in electric shock or fire.

Installation

Follow these instructions carefully to ensure proper installation of the washing machine and to prevent accidents when doing laundry.

What's included

Make sure all the parts are included in the product package. If you have a problem with the washing machine or the parts, contact a local Samsung customer centre or the retailer.

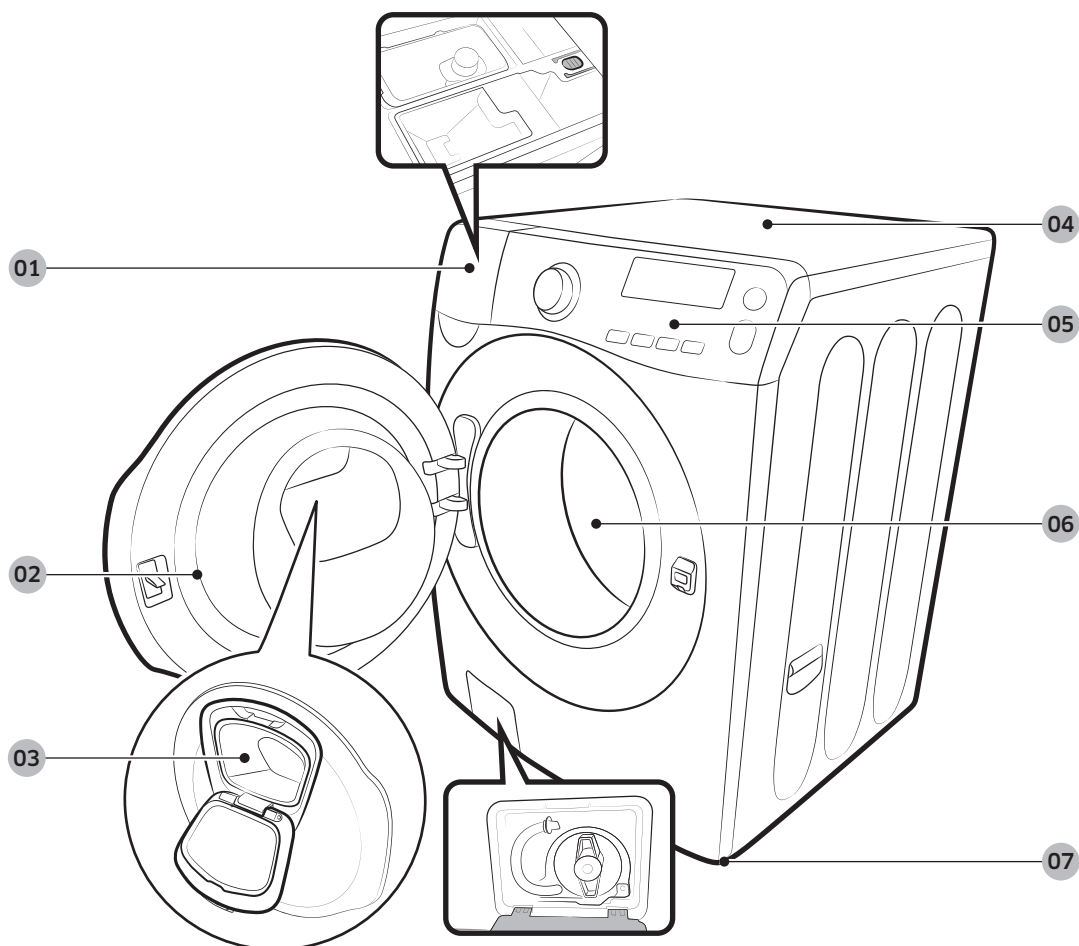

01 Detergent drawer

02 Door

03 Add Door

04 Worktop

05 Control panel

06 Drum

07 Levelling feet



Spanner



Bolt caps



Drain hose

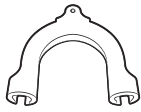

Hose guide



Cold water hose

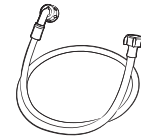

Hot water hose

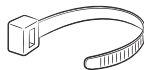

Cable tie

 **NOTE**

- **Bolt caps:** The provided number (3 to 6) of bolt caps depends on the model.
- **Hot water hose:** Applicable models only.
- The appearance of the machine and provided accessories may differ with the model.
- If you lose an accessory and want to purchase a replacement, contact a local Samsung customer center or the retailer.

 **CAUTION**

- Do not reuse old water hoses, which may leak or burst, causing flooding and/or property damage.
- Make sure the rubber washers are inserted in each coupling of the water hose.

 **NOTE**

An adjustable wrench or 10 mm open-end wrench is required for removing the shipping bolts.



Installation

Installation requirements

Electrical supply and grounding

- AC 220 - 240 V / 50 Hz fuse or circuit breaker is required.
- Use an individual branch circuit specific to the washing machine.

To ensure proper grounding, the washing machine comes with a power cord featuring a three-prong grounding plug for use in a properly installed and grounded outlet.

Check with a qualified electrician or service person if you are not sure about the grounding.

Do not modify the provided plug. If it does not fit the outlet, call a qualified electrician to install a proper outlet.

WARNING

- Do NOT use an extension cord.
- Use only the power cord that comes with the washing machine.
- Do NOT connect the ground wire to plastic plumbing, gas lines, or hot water pipes.
- Improperly connected grounding conductors may cause electric shock.

Water supply

A proper water pressure for this washing machine is between 50 kPa and 800 kPa. Water pressure less than 50 kPa may cause the water valve not to close completely. Or, it may take longer to fill the drum, causing the washing machine to turn off. Water taps must be within 120 cm from the rear of the washing machine so that the provided inlet hoses reach the washing machine.

To reduce the risk of leaks:

- Make sure water taps are easily accessible.
- Turn off the taps when the washing machine is not in use.
- Check for any leaks at the water inlet hose fittings on a regular basis.

CAUTION

Before using the washing machine for the first time, check all connections at the water valve and taps for any leaks.

Drain

Samsung recommends a standpipe in height of 60-90 cm. The drain hose must be connected through the hose clip to the standpipe, and the standpipe must fully cover the drain hose.



Flooring

For best performance, the washing machine must be installed on a solid floor. Wood floors may need to be reinforced to minimize vibration and/or unbalanced loads. Carpeting and soft tile surfaces are not a good resistance to vibrations and may cause the washing machine to move slightly during the spin cycle.

CAUTION

Do NOT install the washing machine on a platform or a poorly supported structure.

Water temperature

Do not install the washing machine in areas where water may freeze as the washing machine always retains some water in its water valves, pumps, and/or hoses. Frozen water left in the connection parts may cause damage to belts, the pump, and other components of the washing machine.

Alcove or closet installation

Minimum clearance for stable operation:

Sides	25 mm
Top	25 mm
Rear	50 mm
Front	550 mm

If both the washing machine and a dryer are installed in the same location, the front of the alcove or closet must have at least a 550 mm unobstructed air opening. Your washing machine alone does not require a specific air opening.

Installation

Step-by-step installation

STEP 1 Select a location

Location requirements:

- Solid, level surface without carpeting or flooring that may obstruct ventilation
- Away from direct sunlight
- Adequate room for ventilation and wiring
- The ambient temperature is always higher than the freezing point (0 °C)
- Away from a heat source

STEP 2 Remove the shipping bolts

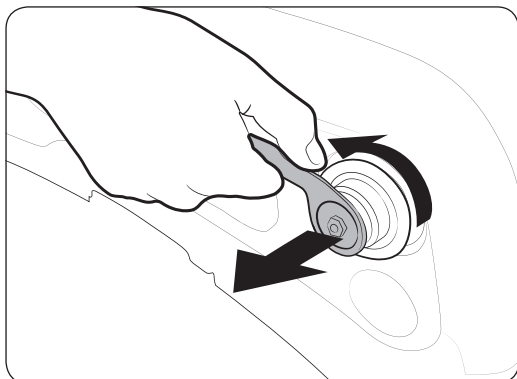

Unpack the product package and remove all shipping bolts.

1. Loosen all shipping bolts on the rear of the machine using the supplied spanner.

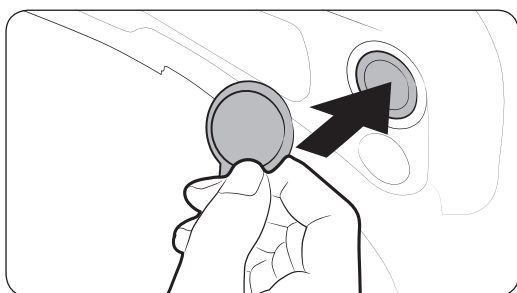

2. Fill the holes with the supplied plastic bolt caps.
Keep the shipping bolts for future use.

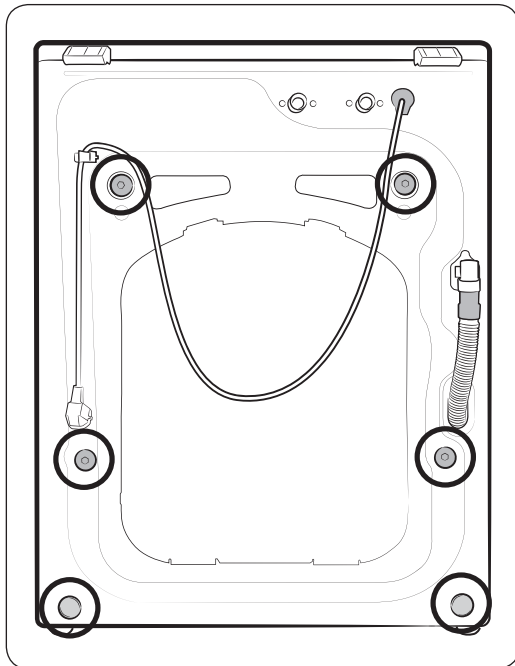

3. Close all plastic bolt caps on the rear of the washing machine.

⚠ WARNING

Packaging materials can be dangerous to children. Dispose all packaging material (plastic bags, polystyrene, etc.) out of children's reach.

Installation

STEP 3 Adjust the levelling feet

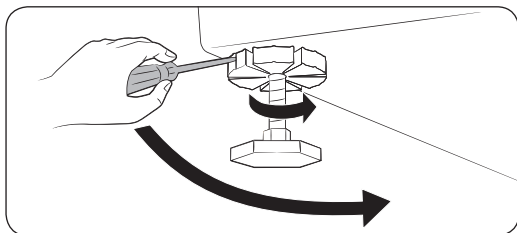
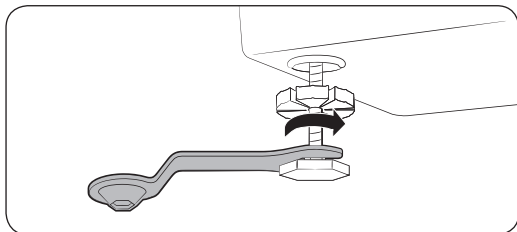

1. Gently slide the washing machine into position. Excessive force may damage the levelling feet.
2. Level the washing machine by manually adjusting the levelling feet. The levelling feet can be loosened using the provided spanner.
3. When levelling is complete, tighten the nuts using a screwdriver as shown.

NOTE

When installing the washing machine, ensure that the power plug, water supply, and drain hoses are easily accessible.

STEP 4 Connect the water hose

The provided hose adaptor may differ with the model. This step guides you through connecting the connector-type adaptor. If you are provided with the screw-type adaptor, go to 7.

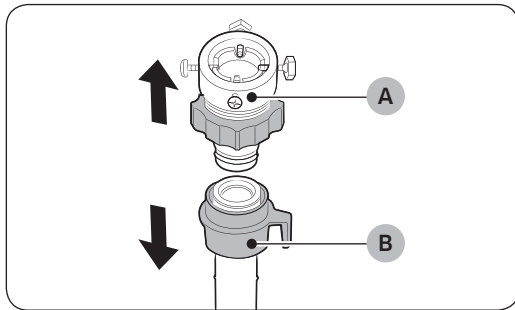

Connect the water hose to the water tap.

1. Remove the adaptor (A) from the water hose (B).

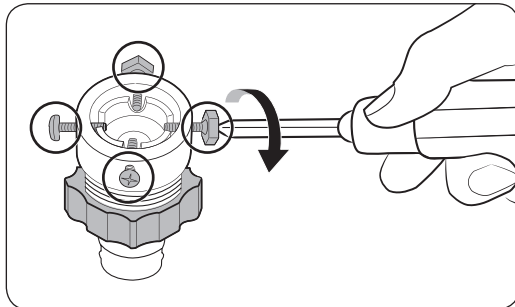

2. Use a Philips screwdriver to loosen four screws on the adaptor.

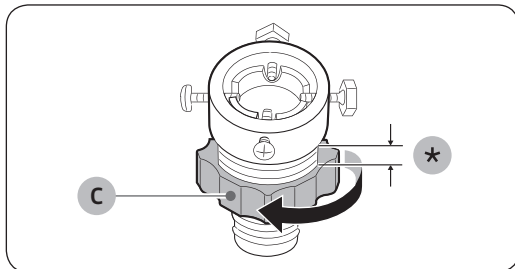

3. Hold the adaptor and turn part (C) in the arrow direction to loosen it by 5 mm (*).

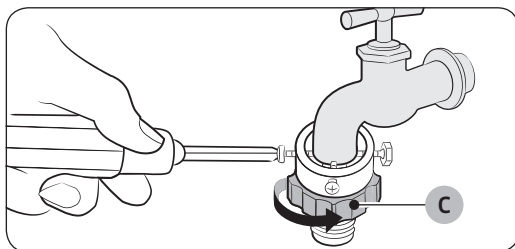

4. Insert the adaptor into the water tap, and tighten the screws while lifting up the adaptor.
5. Turn part (C) in the arrow direction to tighten it.

Installation

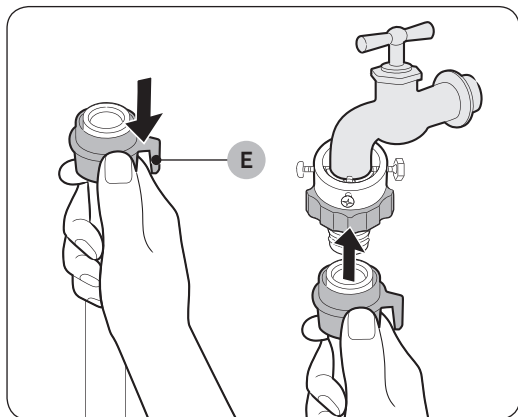

6. While holding down **part (E)**, connect the water hose to the adaptor. Then, release **part (E)**. The hose fits into the adaptor with a clicking sound.

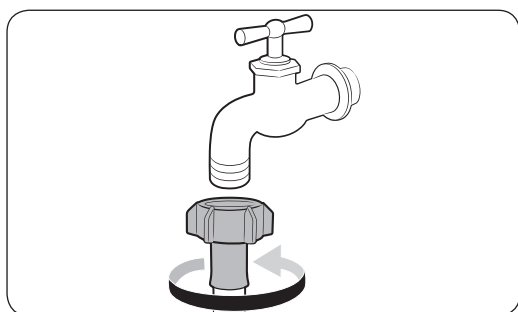

7. If you are using a screw type of water tap, use the provided screw-type adaptor to connect to the water tap as shown.

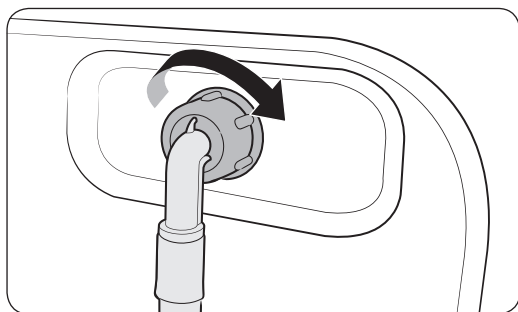

8. Connect the other end of the water hose to the inlet valve on the back of the washing machine. Turn the hose clockwise to tighten.

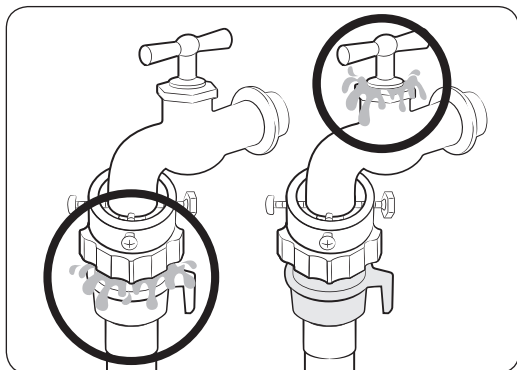

9. Open the water tap and check if there are any leaks around the connection areas. If there are water leaks, repeat the steps above.

⚠ WARNING

Stop using the washing machine if there is a water leak, and contact a local Samsung service centre. Otherwise, this may cause electric shock.

⚠ CAUTION

Do not stretch the water hose by force. If the hose is too short, replace the hose with a longer, high-pressure hose.

📄 NOTE

- After connecting the water hose to the adaptor, check if it is connected properly by pulling the water hose downwards.
- Use a popular type of water taps. If the tap is square-shaped or too big, remove the spacer ring before inserting the tap into the adaptor.
- Make sure the water lines (cold/hot) are properly connected and the valves are open.

Installation

For models with an additional hot water inlet:

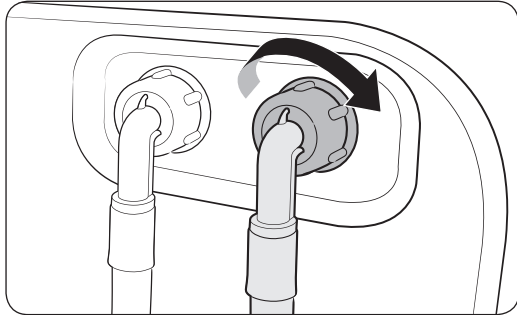

1. Connect the red end of the hot water hose to the hot water inlet on the back of the machine.
2. Connect the other end of the hot water hose to the hot water tap.

⚠ CAUTION

As the hot water temperature can only be controlled by hot water-related cycles, make sure to connect the hot water supply to the hot water hose.

Aqua hose (applicable models only)

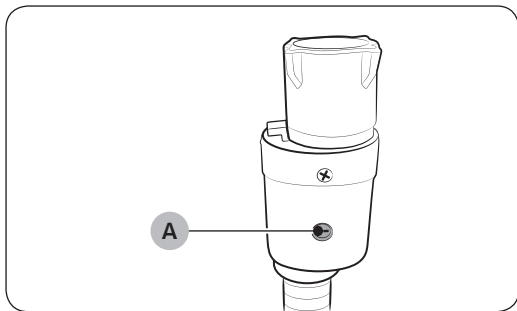

The aqua hose alerts users of a risk of water leaks. It senses the water flow and turns red on the centre indicator (A) in case of a leak.

📄 NOTE

The end of the aqua stop hose must be fitted to the water tap and not the machine.

STEP 5 Connect the drain hose

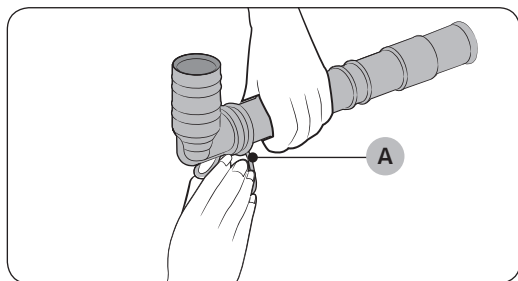

1. Press the catches of the clamp (A) and insert the drain hose into the clamp.

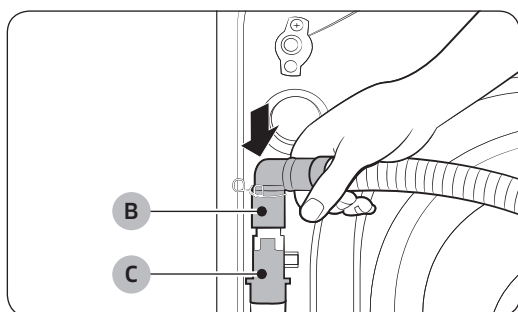

2. Insert the drain hose into the extension hose (C) of the washing machine firmly by pressing the catches of the clamp. Then, release them to fix the drain hose (B).

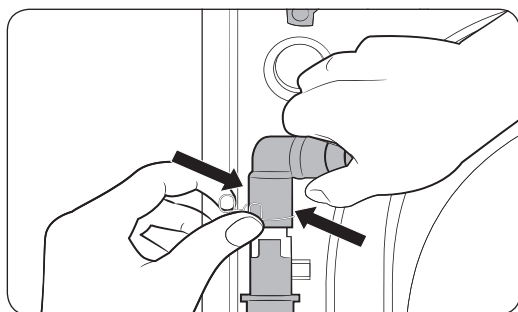

3. Fully insert the end of the drain hose into the drain hole.

NOTE

The drain outlet of the washing machine may be on the left or right depending on the model.

Installation

STEP 6 Position the drain hose

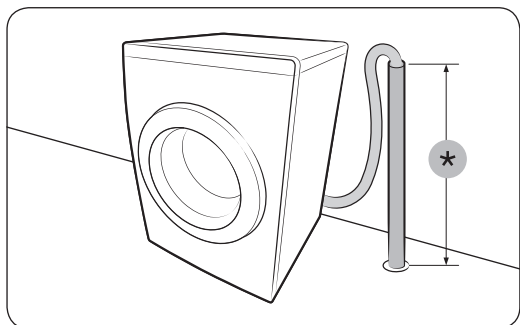

In a sink drain pipe

The drain pipe must be above the sink siphon so that the end of the hose is at least 60 cm above the floor.

In a drain pipe

The drain pipe should be between 60 cm and 90 cm high (*). It is advisable to use a 65 cm high vertical pipe. Make sure the drain hose is connected to the stand pipe at a slant.

Drain standpipe requirements:

- Minimum diameter of 5 cm
- Minimum carry-away capacity of 60 litres per minute

STEP 7 Power on

Plug the power cord into a wall socket featuring an AC 220 - 240 V / 50 Hz approved electrical outlet protected by a fuse or circuit breaker. Then, press **POWER** to turn on the washing machine.

Environment

Please dispose of the packaging materials for this product in an “environmentally friendly” manner. For further detail, please contact your local area authority.

Before you start

Initial settings

Run Calibration (recommended)

Calibration ensures accurate weight detection by the washing machine. Make sure the drum is empty before running Calibration.

1. Power off, and then power on the washing machine.
2. Hold down **Temp.** and **Delay End** simultaneously for 3 seconds to enter Calibration mode. The “Cb” message appears.
3. Press **START/PAUSE** to run the Calibration cycle.
4. The drum rotates clockwise and counter-clockwise for about 3 minutes.
5. When the cycle is complete, “0” appears on the display and the washing machine turns off automatically.
6. The washing machine is now ready for use.

Before you start

Laundry guidelines

STEP 1 Sort

Sort the laundry according to these criteria:

- Care Label: Sort the laundry into cottons, mixed fibres, synthetics, silks, wools, and rayon.
- Colour: Separate whites from colours.
- Size: Mixing different sized items together in the drum improves the washing performance.
- Sensitivity: Wash delicate items separately for pure, new woollen items, curtains, and silk items. Check the labels on the items.

NOTE

Make sure to check the care label on the clothing, and sort them accordingly before starting the wash.

STEP 2 Empty pockets

Empty all the pockets of your laundry items

- Metal objects such as coins, pins, and buckles on clothing may damage other laundry items as well as the drum.

Turn clothing with buttons and embroideries inside out

- If pants or jacket zippers are open while washing, the drum may be damaged. Zippers should be closed and fixed with a string.
- Clothing with long strings may become entangled with other clothes. Make sure to tie the strings before starting the wash.

STEP 3 Use a laundry net

- Brassieres (water washable) must be placed in a laundry net. Metal parts of the brassieres may break through and tear other laundry items.
- Small, light clothing such as socks, gloves, stockings, and handkerchiefs may become caught around the door. Place them inside a fine laundry net.
- Do not wash the laundry net by itself without other laundry. This may cause abnormal vibrations that could move the washing machine and result in injury.

STEP 4 Determine the load capacity

Do not overload the washing machine. Overloading may cause the washing machine to not wash properly. For the load capacity for the type of clothing, see page 39.

NOTE

When washing bedding or bedding covers, the wash time may be lengthened or the spin efficiency may be reduced. For bedding or bedding covers, the recommended maximum spin cycle speed is 800 rpm, and the load capacity is 2.0 kg or less.

CAUTION

If the laundry is unbalanced and the “Ub” information code is displayed, redistribute the load. Unbalanced laundry may reduce the spinning performance.

STEP 5 Apply a proper detergent type

The type of detergent depends on the type of fabric (cotton, synthetic, delicate items, wool), colour, wash temperature, and degree of soiling. Always use “low suds” laundry detergent, which is designed for automatic washing machines.

NOTE

- Follow the detergent manufacturer's recommendations based on the weight of the laundry, the degree of soiling, and the hardness of the water in your local area. If you are not sure about the water hardness, contact a local water authority.
- Do not use detergent that tends to be hardened or solidified. This detergent may remain after the rinse cycle, blocking the drain outlet.

CAUTION

When washing wool using the Wool cycle, use only a neutral liquid detergent. If used with the Wool cycle, powder detergent may remain on the laundry and discolour the laundry.

Before you start

Detergent drawer guidelines

The washing machine provides a four-compartment dispenser: two compartments for manual input, and the other two for auto dispensing. With Auto Detergent and Auto Softener enabled, the washing machine dispenses an adequate amount of detergent or fabric softener for each load. See below for details:

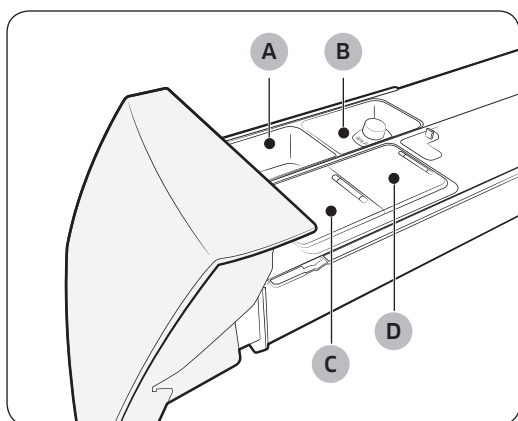

- A. Detergent:** Use this to add powder or liquid detergent manually.
- B. Softener:** Use this to add fabric softener manually.
- C. Auto Detergent:** Use liquid detergent only.
- D. Auto Softener:** Use fabric softener only.

CAUTION

- Do not open the detergent drawer while the washing machine is operating.
- Do not use the following types of detergent:
 - Tablet or capsule types
 - Ball or net types
- To prevent the compartment from clogging, concentrated or highly-enriched agents (fabric softener or detergent) must be diluted with water before being applied.
- Before moving the washing machine, make sure to empty the detergent drawer that might contain detergent and/or fabric softener. The content in the drawer may spill out on the floor.

To refill the detergent or fabric softener

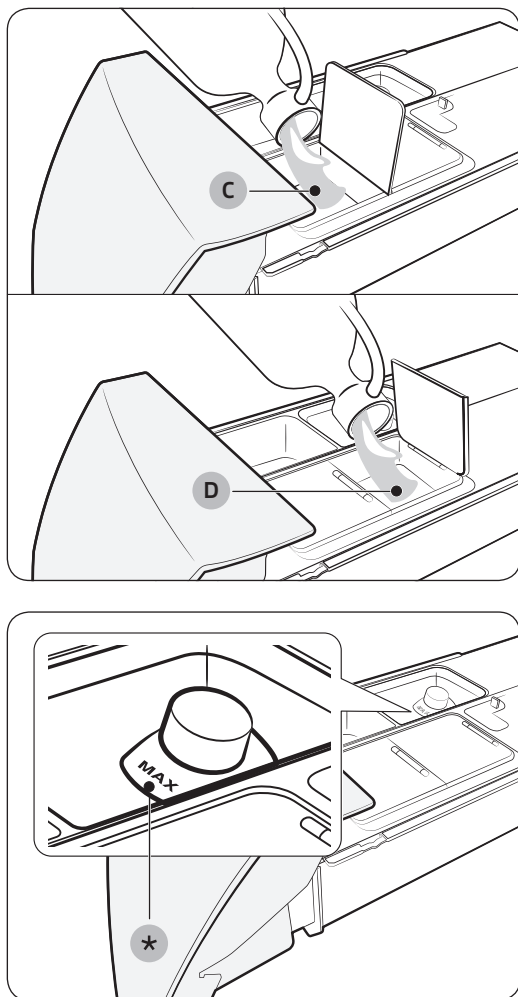

1. Slide open the detergent drawer.
2. Apply an appropriate amount of detergent to the **Auto Detergent compartment (C)**. If necessary, apply an appropriate amount of fabric softener to the **Auto Softener compartment (D)** if necessary.
3. Slide the detergent drawer inward. Make sure the door is closed.

CAUTION

- Do not exceed the **max line (*)** which is marked on the compartment.
- When using powdered detergent, it is recommended that the powder should be dissolved in warm water to ensure optimum cleaning results.

Before you start

Operations

Control panel

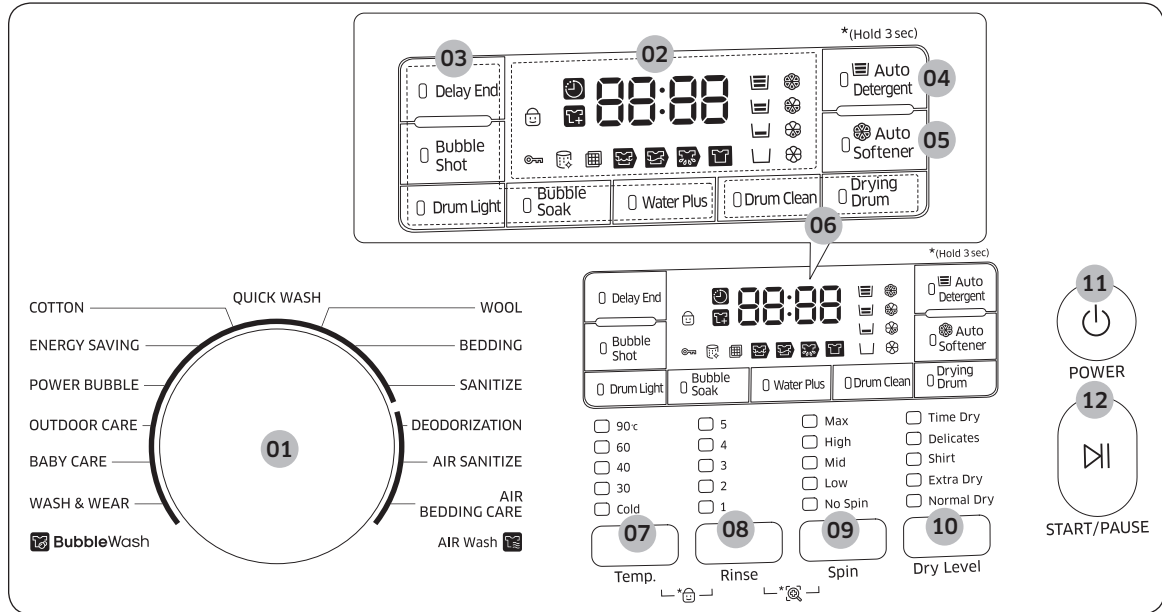

01 Cycle Selector	Turn the dial to select a cycle.
02 Display	The display shows current cycle information and estimated time remaining, or an information code when an abnormal situation occurs.
03 Options	Press to select an option. Select an option to your needs or convenience. Available options are: Bubble Shot , Bubble Soak , Water Plus , Drum Clean Light , and Delay End .
04 Auto Detergent	The washing machine dispenses detergent automatically according to the load.
05 Auto Softener	The washing machine dispenses fabric softener automatically according to the load.
06 Maintenance	Useful for cleaning the drum. Available functions are: Drum Clean and Drying Drum
07 Temp.	Press to change the water temperature for the current cycle.
08 Rinse	Press to change the rinse count for the current cycle. You can set the rinse count to a max of 5.
09 Spin	Press to change the spinning speed for the current cycle. <ul style="list-style-type: none"> No Spin ∅: The drum does not spin after the final drain process.

10 Dry Level	<p>Press to select a dry level.</p> <ul style="list-style-type: none"> • Normal Dry: Use to dry laundry such as cotton, underwear, and linen. • Extra Dry: Use to dry heavy laundry such as jeans and towels. • Shirt: Use when want to quickly dry one shirt. (In 20 minutes) • Delicates: Use to dry heat-sensitive laundry. This protects the fibers of the laundry by drying it at low temperatures. • Time Dry: Use to dry the laundry for a specified period of time according to the material, load, and moisture.
11 POWER	Press to turn on/off the washing machine.
12 START/PAUSE	Press to start or stop operation.

Simple steps to start

Standard steps

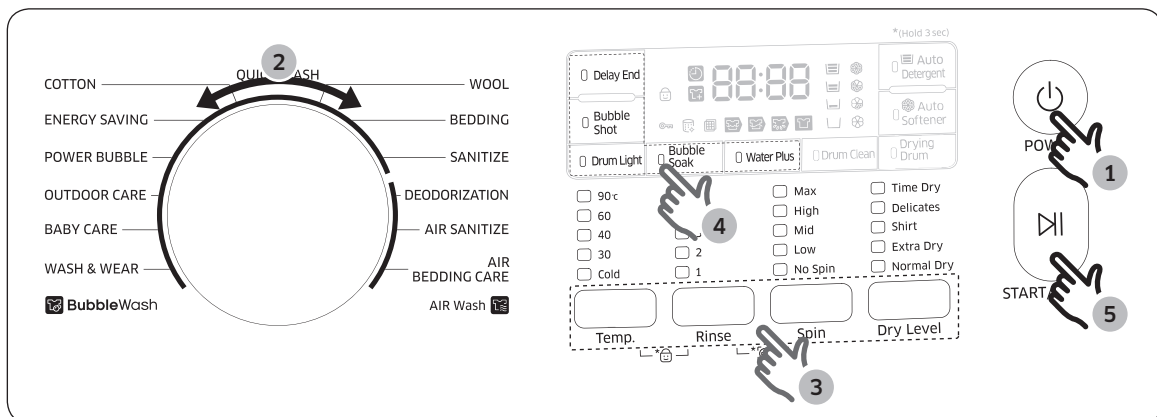

1. Press **POWER** to turn on the washing machine.
2. Turn the **Cycle Selector** to select a cycle.
3. Change the cycle settings (**Temp.**, **Rinse**, **Spin**, and **Dry Level**) as necessary.
4. Select a preferred option(s) for the cycle. The corresponding indicator(s) light up with the estimated running time on the display.
5. Press **START/PAUSE**.

Operations

Drying only

Follow these steps to dry damp laundry or laundry that has just finished washing.

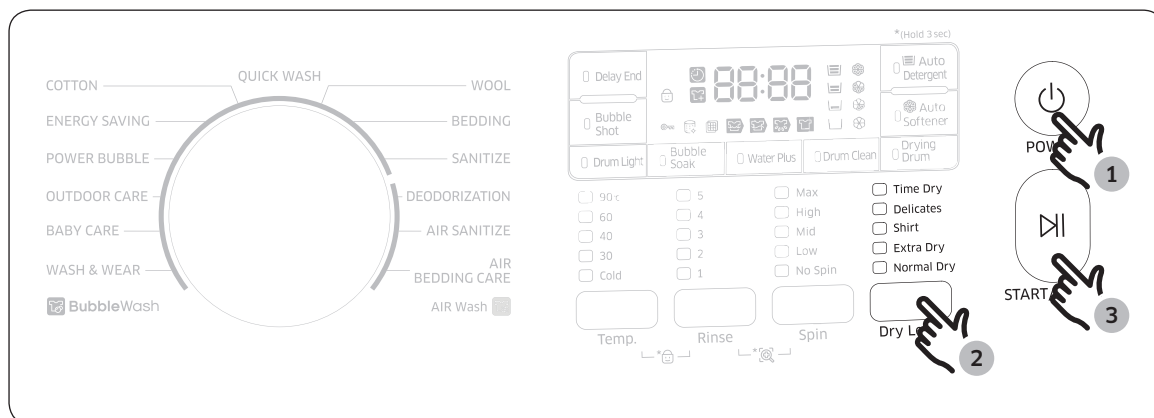

1. Press **POWER** to turn on the washing machine.
2. Press **Dry Level** repeatedly until a desired dry level is set.
3. Press **START/PAUSE**.

To change the cycle during operation

1. Press **START/PAUSE** to stop operation.
2. Select a different cycle.
3. Press **START/PAUSE** again to start the new cycle.

Cycle overview

Standard cycles

Cycle	Description & Max load (kg)	
COTTON	<ul style="list-style-type: none"> For cottons, bed linens, table linens, underwear, towels, or shirts. The washing time and the rinse count are automatically adjusted according to the load. 	MAX
ENERGY SAVING	<ul style="list-style-type: none"> Optimal performance with lower energy for cotton fabrics, bed linens, table linens, underwear, towels, or shirts. The washing operation starts at the end of the main wash hot fill operation. 	13
POWER BUBBLE	<ul style="list-style-type: none"> For badly soiled laundry. 	MAX
OUTDOOR CARE	<ul style="list-style-type: none"> For outdoor clothes, skiwear, and sportswear that are made of functional materials such as spandex, stretch, and micro-fibre. 	3
BABY CARE	<ul style="list-style-type: none"> Featuring a high-temperature wash and extra rinses to help remove the remaining detergent effectively. 	9
WASH&WEAR	<ul style="list-style-type: none"> Specific to quickly wash and dry relatively clean laundry from washing to drying. 	5
QUICK WASH	<ul style="list-style-type: none"> Specific to less soiled laundry with less than a 5.0 kg load. It takes at least 19 minutes, depending on the conditions such as the water pressure, water hardness, and/or extra options selected. A recommended amount of detergent is less than 20 g (for a 5.0 kg load) 	5
WOOL	<ul style="list-style-type: none"> Specific for machine-washable wool for loads less than 2.0 kg. The Wool cycle features gentle cradling and soaking to protect the wool fibres from shrinkage/distortion. A neutral detergent is recommended. 	2
BEDDING	<ul style="list-style-type: none"> For bed spreads, bed sheets, bedding covers, etc. For best results, wash only 1 type of bedding and make sure the load weighs less than 2.0 kg. 	4

Operations

Cycle	Description & Max load (kg)
SANITIZE	<ul style="list-style-type: none"> For colorfast fabrics and heavily soiled laundry, this cycle heats the supplied water up to 60 °C to eliminate bacteria. If you stop running the cycle while the washing machine is heating the water, the door remains locked for your safety.

AIR Wash cycle

AIR Wash refreshes laundry through Samsung's unique air-washing technology without the need for water. AIR Wash is not a drying cycle. Use this only for dried laundry.

Cycle	Description & Max load (kg)
DEODORIZATION	<ul style="list-style-type: none"> Removes bad odors from the laundry.
AIR SANITIZE	<ul style="list-style-type: none"> Removes bad odors and bacteria from the laundry.
AIR BEDDING CARE	<ul style="list-style-type: none"> Removes bad odors, bacteria, and dust from the laundry.

CAUTION

Do not use any AIR Wash cycle for the following items:

- Heat-sensitive cycles made from leather, mink, fur, or silk
- Delicate items, such as lace-trimmed underwear, doll cushions, or dress suits, etc.
- Clothes trimmed with buttons (can break)
- Clothes full of starch (may become deformed)
- Hard bedding
- Wooden pillows and neck rests
- Pillows or blankets filled with plastic beads or buckwheat
- Electric blankets, furry, or bulky blankets
- Latex pillows
- Waterproof breathable garments

NOTE

For ripped, scratched, or chemically-contaminated laundry, the water repellency restoration efficiency can be reduced.

Options

Option	Description
Delay End	<ul style="list-style-type: none"> The displayed time refers to the end time of a selected cycle.
Bubble Shot	<p>Bubble Shot creates bubbles inside the drum that help the detergent penetrate into the fabric faster and more effectively. Bubble Shot produces cleaner results in less time and protects the fabric from being damaged.</p> <ul style="list-style-type: none"> Bubble Shot is active by default for all washing cycles. You cannot deactivate Bubble Shot for POWER BUBBLE, OUTDOOR CARE, WASH&WEAR, WOOL, and Quick Wash. Once a washing cycle starts, Bubble Shot cannot be activated/deactivated. Do not apply detergent excessively. A specified amount of detergent generates sufficient bubbles. Clean the debris filter regularly to help generate sufficient bubbles. The size and quantity of the bubble depends on the detergent and laundry. Although bubbles are generated immediately after a cycle starts, it may take several minutes for them to become visible.
Bubble Soak	<p>Bubble Soak helps remove a variety of stubborn stains.</p> <ul style="list-style-type: none"> With Bubble Soak selected, laundry is thoroughly soaked in water bubbles for effective washing. Bubble Soak adds up to 30 minutes to the selected cycle. Availability of this option depends on the cycle.
Drum Light	<ul style="list-style-type: none"> Press to turn on/off the Drum Light. The drum light turns off automatically after 2 minutes.
Water Plus	<ul style="list-style-type: none"> This adds extra water immediately before the rinse cycle to improve rinsing effects.

Operations

Delay End

You can set the washing machine to finish your wash automatically at a later time, choosing a delay of between 1 to 24 hours (in 1 hour increments). The hour displayed indicates the time the wash finishes.

1. Select a cycle. Then change the cycle settings if necessary.
2. Press **Delay End** repeatedly until a desired end time is set.
3. Press **START/PAUSE**.
The corresponding indicator turns on with the clock running.
4. To cancel the **Delay End**, restart the washing machine by pressing **POWER**.

Real-life case

You want to finish a two-hour cycle 3 hours later from now. For this, you add the Delay End option to the current cycle with the 3-hour setting, and press **START/PAUSE** at 2:00 p.m. Then, what happens? The washing machine starts operating at 3:00 p.m., and ends at 5:00 p.m. Provided below is the time line for this example.

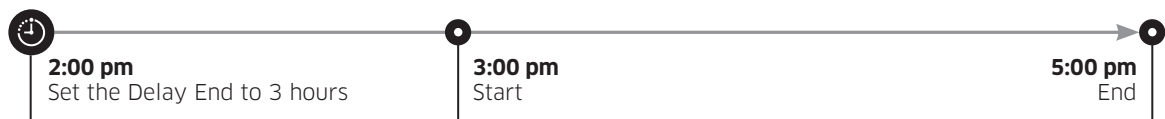

Special features

User convenience & maintenance

Option	Description
Drum Clean	<p>Clean the drum by removing dirt and bacteria from the drum.</p> <ul style="list-style-type: none">• Run this once every 40 washes with no detergent or bleach applied.• Make sure the drum is empty with no cleaning agents.
Drying Drum	<ul style="list-style-type: none">• Clean and dry the drum using the hot air after washing is complete.

AddWash

When the AddWash indicator  is on, you can stop operation of the machine and put additional laundry or softener into the drum. The Add Door opens by more than 130° for easy access.

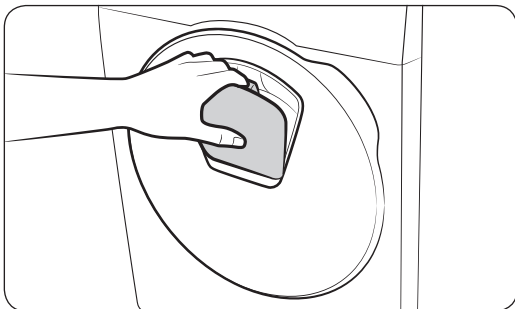
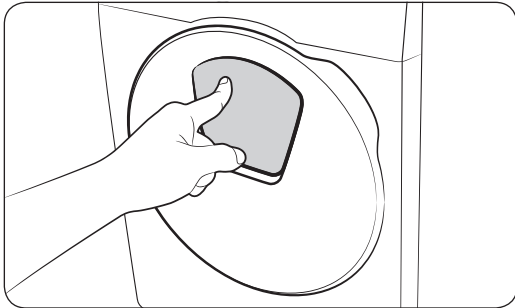

1. Press **Start/Pause** to stop operation.
2. Press the upper area of the Add Door until you hear a clicking sound to unlock. Pull the handle of the Add Door to open.

3. Open the Add Door and put additional laundry or softener into the drum.
4. Push the Add Door until you hear a clicking sound to close.
5. Press **Start/Pause** to resume operation.

CAUTION

Do not put excessive force on the Add Door. It may break.

NOTE

The water inside the drum will not leak if the Add Door is closed properly. Water drops may form around the door, but they will not leak from inside the drum.

CAUTION

- Do not open the Add Door if suds have formed inside the drum that rise above the level of the Add Door.
- Do not attempt to open the Add Door while the machine is operating without first pressing **Start/Pause**. Please note that the Add Door can be opened unintentionally (without pressing **Start/Pause**) when the wash is complete.
- Do not add an excessive load through the Add Door. Performance may be degraded.
- Do not use the lower area of the Add Door as a handle. Your fingers may be caught.
- Make sure that no laundry is caught in the Add Door.
- Keep your pets out of the washing machine, especially the Add Door.
- Do not press to open the Add Door while the drying or boiling process is running. Hot steam may leak out of the door.

Operations

- When the Add Door closes, the door seals up and no water can leak. However, you may encounter what appears to be water leak around the door - some residual water remaining around the Add Door may form water drops. This is normal.
- Neither the main door or the Add Door can be opened when the water temperature is over 50 °C. If the water level inside the drum is over a certain point, the main door cannot be opened.
- If an information code of **DDC** appears on the display, see the Information codes section for further actions.

Settings

Child Lock

Child Lock is designed to prevent accidents by children or the elderly and infirm. Child Lock locks all buttons except for the **POWER** button.

To activate Child Lock

- Hold down both **Temp.** and **Rinse** simultaneously for 3 seconds. The Child Lock indicator  turns on. If a button is pressed with Child Lock activated, the indicator blinks.

To deactivate Child Lock

- Hold down both **Temp.** and **Rinse** simultaneously for 6 seconds. The indicator turns off.

To deactivate Child Lock temporarily and open the door

- Hold down both **Temp.** and **Rinse** simultaneously for 3 seconds. Child Lock is deactivated temporarily for 1 minute, and the indicator blinks. Add laundry, for example, and close the door within the next 2 minutes. Otherwise, the machine sounds an alert for another 2 minutes. Once you close the door, Child Lock will be reactivated with the indicator turned on.

WARNING

Do not let children play around the machine. They may enter the machine and be trapped, resulting in suffocation.

CAUTION









Do not try to open the door while Child Lock is active. Product damage may occur.

NOTE

- Child Lock stays active after the machine powers off. To add laundry, you must deactivate Child Lock first. For details, see the deactivation section above.
- Once Child Lock is activated, the door locks for the first 5 seconds and then unlocks temporarily for the next 5 seconds. Then, the door locks again. In summary, the door locks normally after the first 10 seconds.

Operations

Auto Detergent/Auto Softener

1. Press the **Auto Detergent** button to cycle through the following settings: Standard  > Extra  > Disable  > Economy 
Press the **Auto Softener** button to cycle through the following settings: Standard  > Extra  > Disable  > Economy 
2. Press and hold **Auto Detergent** and **Auto Softener** simultaneously for 3 seconds. Then, press the **Auto Detergent** or **Auto Softener** to set the concentration level:
1 (Normal) > 2 (2X concentration) > 3 (3X concentration)
3. Press and hold **Auto Detergent** and **Auto Softener** simultaneously for 3 seconds to confirm your changes.

NOTE

- If the Auto Detergent indicator blinks, refill the Auto Detergent compartment with the detergent.
- If the Auto Softener indicator blinks, refill the Auto Softener compartment with the fabric softener.
- If you select WOOL or OUTDOOR CARE, the Auto Detergent/Auto Softener will be disabled automatically. However, you can enable the function(s) manually after selecting a cycle.

Anti-freezing

Use the **Anti-freezing** cycle when you leave the house for a long period of time or if the temperature is very cold. To prevent the washing machine from freezing, the washing machine continuously supplies and drains water up to 16 hours and then stops automatically.

To use Anti-freezing

1. Make sure the washing machine door is closed and the drum is empty.
2. Press and hold **Delay End** and **Spin** simultaneously for 3 seconds.
3. The cycle begins with the weight sensor activated. The progress of the cycle is represented in a rotating bar on the display as shown.

Maintenance

Keep the washing machine clean to prevent deteriorated performance and to preserve its life cycle.

Drum clean

Perform this cycle regularly to clean the drum and to remove bacteria from it.

1. Press **POWER** to turn on the washing machine.
2. Press **Drum Clean**.
3. Press **START/PAUSE**.

NOTE

The water temperature for DRUM CLEAN is set to 60 °C, which cannot be changed.

CAUTION

Do not use any cleaning agents for cleaning the drum. Chemical residue in the drum deteriorates the washing performance.

DRUM CLEAN reminder

- The DRUM CLEAN  reminder appears on the main display once every 40 washes. It is advisable to perform the DRUM CLEAN regularly.
- When you first see this reminder, you can ignore the reminder for 6 consecutive washes. From the 7th wash, the reminder no longer appears. However, it appears again on the second 40th wash.

Maintenance

Smart Check

To enable this function, you must first download the Samsung Smart Washer app at the Play Store or the App Store, and install it on a mobile device featuring a camera function.

The Smart Check function has been optimized for Galaxy & iPhone series (applicable models only).

1. Press and hold **Rinse** and **Spin** simultaneously for 3 seconds to enter the Smart Check mode.
2. The washing machine starts the self-diagnosis procedure and displays an information code if a problem is detected.
3. Run the Samsung Smart Washer app on your mobile device, and tap Smart Check.
4. Put the mobile device close to the washing machine's display so that the mobile device and the washing machine face each other. Then, the information code is recognized automatically by the app.
5. When the information code is recognized correctly, the app provides detailed information about the problem with applicable solutions.

NOTE

- The function name, Smart Check, may differ depending on the language.
- If there is strong reflected light on the washing machine display, the app may fail to recognize the information code.
- If the app fails to recognize the Smart Check code consecutively, enter the information code manually onto the app screen.

Emergency drain

In case of a power failure, drain the water inside the drum before taking out the laundry.

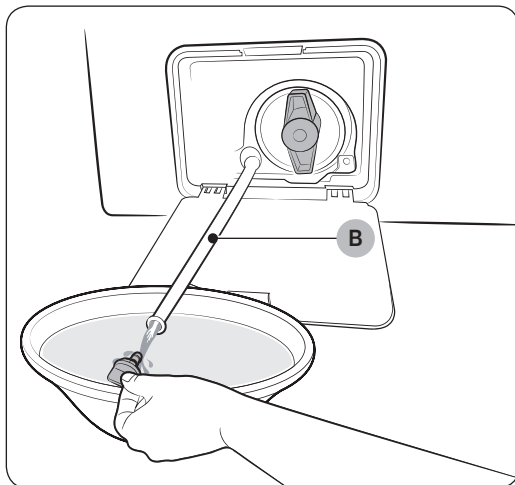
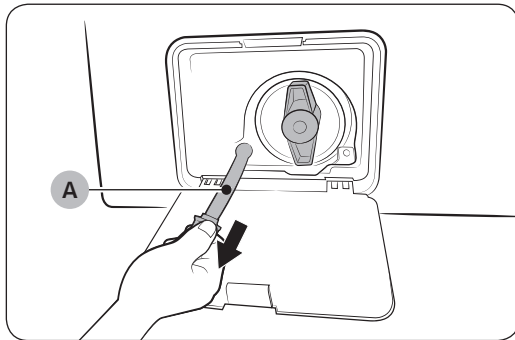
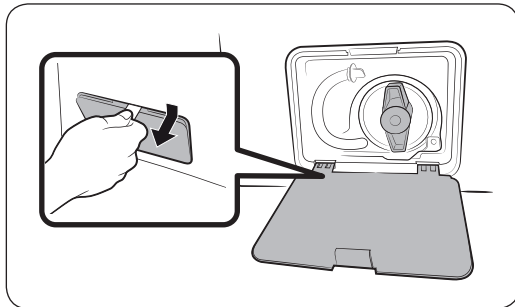

1. Power off and unplug the washing machine from the electrical outlet.
2. Gently press the top area of the filter cover to open.
3. Put an empty, spacious container around the cover, and stretch the emergency drain tube to the container while holding the **tube cap (A)**.
4. Open the tube cap and let water in the **Emergency drain tube (B)** flow into the container.
5. When done, close the tube cap, and reinsert the tube. Then, close the filter cover.

NOTE

Use a spacious container because the water in the drum may be more than expected.

Maintenance

Cleaning

Surface of the washing machine

Use a soft cloth with a nonabrasive household detergent. Do not spray water onto the washing machine.

Add Door

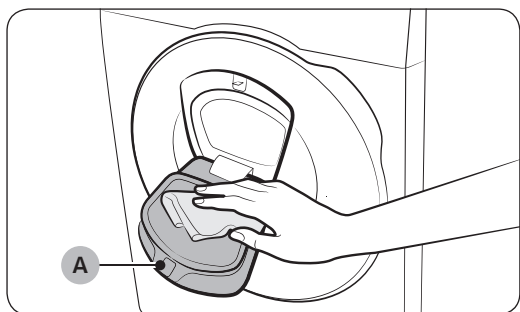

1. Open the Add Door.
2. Use a wet cloth to clean the Add Door.
 - Do not use cleaning agents. Discoloration may occur.
 - Use caution when cleaning the rubber packing and the **locking mechanism (A)**.
 - Dust off the door area regularly.
3. Wipe up and close the Add Door until you hear a clicking sound.

CAUTION

- Do not apply force on the Add Door. It may break.
- Do not leave the Add Door open while the machine is operating.
- Do not put heavy objects on the Add Door at any time.
- To prevent physical injury, do not touch the Add Door while the drum is rotating.
- Do not open the Add Door while the machine is operating. This may cause physical injury.
- Do not manipulate the feature panel while the Add Door is open. This may cause physical injury or system failure.
- Do not input objects other than laundry.
- Do not input bulky items to the drum through the Add Door.
- Do not pull out the rubber packing of the Add Door when cleaning. This may cause damage.

Mesh filter

Clean the mesh filter of the water hose once or twice a year.

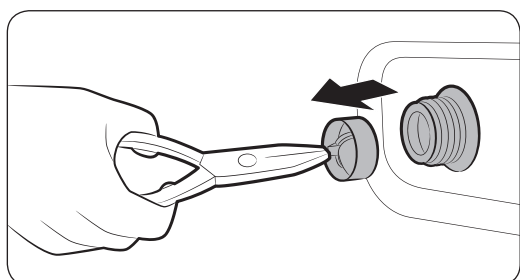
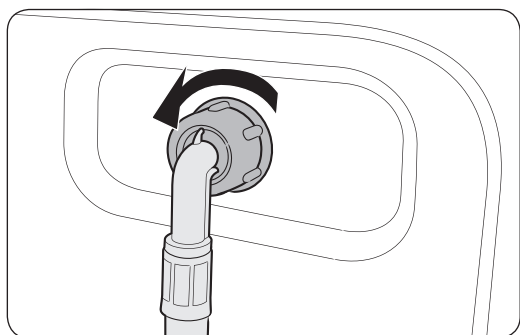

1. Turn off the washing machine, and unplug the power cord.
2. Close the water tap.
3. Loosen and disconnect the water hose from the back of the washing machine. Cover the hose with a cloth to prevent water from gushing out.
4. Use pliers to pull out the mesh filter from the inlet valve.
5. Submerge the mesh filter deeply in water so that the threaded connector is also submerged.
6. Dry the mesh filter completely in the shade.
7. Reinsert the mesh filter into the inlet valve, and reconnect the water hose to the inlet valve.
8. Open the water tap.

NOTE

If the mesh filter is clogged, an information code of “4C” appears on the screen.

Maintenance

Pump filter

It is advisable to clean the pump filter 5 or 6 times a year to prevent its clogging. A clogged pump filter may reduce the bubble effect.

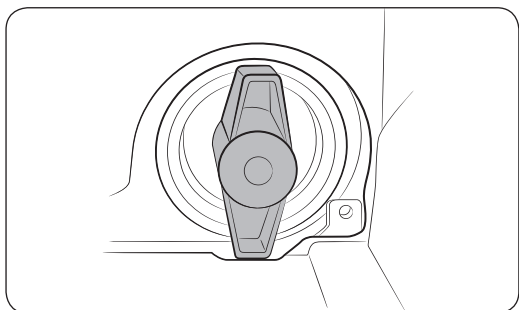
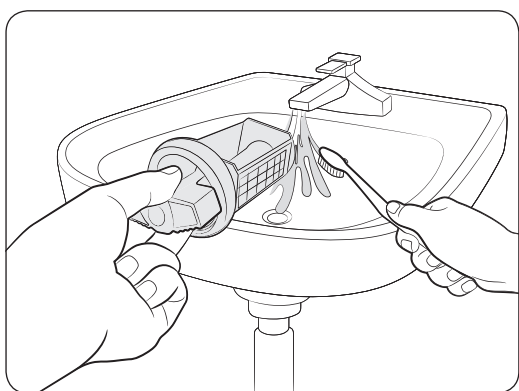
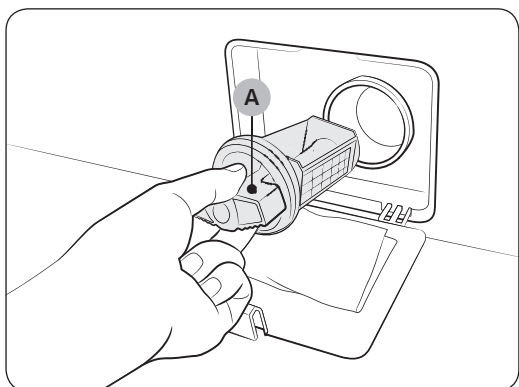

1. Turn off the washing machine, and unplug the power cord.
2. Drain the remaining water inside the drum. See the “**Emergency drain**” section.
3. Open the filter cover using a coin or key.
4. Turn the **pump filter knob (A)** to the left, and drain off the remaining water.
5. Clean the pump filter using soft brushes. Make sure the drain pump propeller inside the filter is unclogged.
6. Reinsert the pump filter, and turn the filter knob to the right.

NOTE

- Some pump filters feature a safety knob that is designed to prevent accidents by children. To open the safety knob of the pump filter, push in and turn it anticlockwise. The spring mechanism of the safety knob helps open the filter.
- To close the safety knob of the pump filter, turn it clockwise. The spring makes a rattling sound, which is normal.

NOTE

If the pump filter is clogged, an information code of “5C” appears on the screen.

 **CAUTION**

- Make sure the filter knob is closed properly after cleaning the filter. Otherwise, this may cause a leak.
- Make sure the filter is inserted properly after cleaning it. Otherwise, this may cause an operational failure or a leak.

Maintenance

Detergent drawer

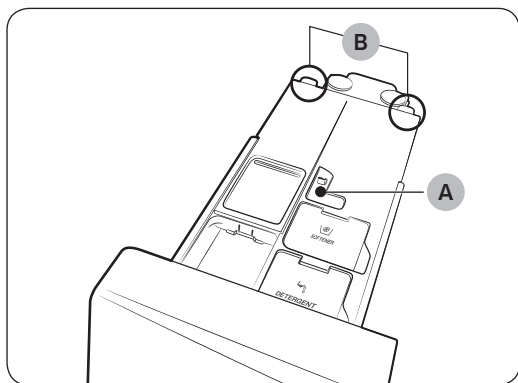

1. While holding down the **release lever (A)** on the inner of the drawer, slide open the drawer.
2. Remove the compartment cover by holding and pulling back **part (B)**.

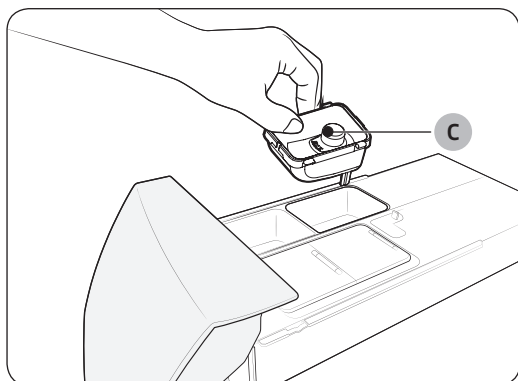

3. Remove the **Liquid softener container (C)** as shown.

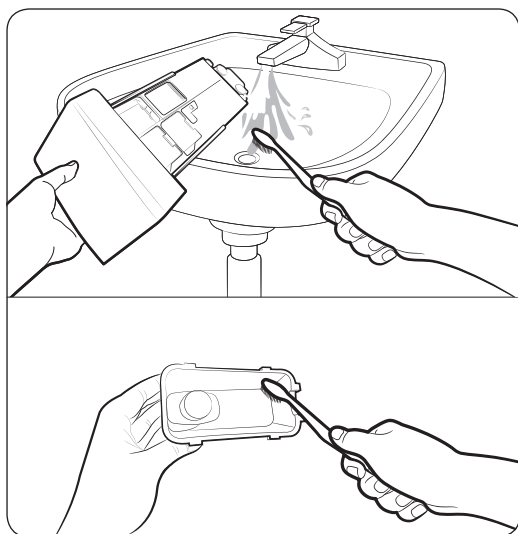

4. Clean the drawer components in flowing water using a soft brush.

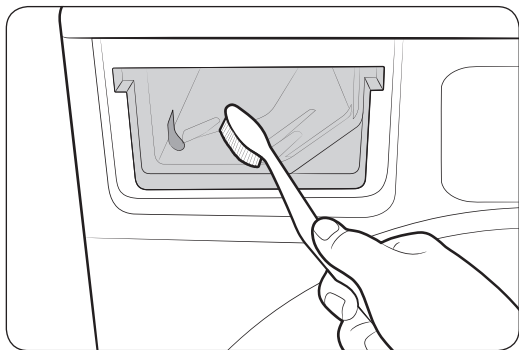

5. Clean the drawer recess using a soft brush.
6. Assemble the compartment cover firmly with the detergent drawer.
7. Slide the drawer inward to close it.

NOTE

To remove remaining detergent, perform the **QUICK WASH** cycle with an empty drum.

Recovery from freezing

The washing machine may freeze when it drops below 0 °C.

1. Turn off the washing machine, and unplug the power cord.
2. Pour warm water over the water tap to loosen the water hose.
3. Disconnect the water hose, and soak it in warm water.
4. Pour warm water into the drum and leave it for about 10 minutes.
5. Reconnect the water hose to the water tap.

NOTE

If the washing machine still doesn't operate normally, repeat the above steps until it operates normally.

Care against an extended time of disuse

Avoid leaving the washing machine unused for an extended time. If this is the case, drain the washing machine and unplug the power cord.

1. Turn the **Cycle Selector** to select **QUICK WASH**.
2. Empty the drum, and press **START/PAUSE**.
3. When the cycle is complete, close the water tap and disconnect the water hose.
4. Turn off the washing machine, and unplug the power cord.
5. Open the door to let air circulate through the drum.

Troubleshooting

Checkpoints

If you encounter a problem with the washing machine, first check the table below and try the suggestions.

Problem	Action
Does not start.	<ul style="list-style-type: none">• Make sure the washing machine is plugged in.• Make sure the door is properly closed.• Make sure the water taps are open.• Make sure to press or tap START/PAUSE to start the washing machine.• Make sure Child Lock is not activated.• Before the washing machine starts to fill, it will make a series of clicking noises to check the door lock and does a quick drain.• Check the fuse or reset the circuit breaker.
Water supply is insufficient, or no water is supplied.	<ul style="list-style-type: none">• Fully open the water tap.• Make sure the door is properly closed.• Make sure the water supply hose is not frozen.• Make sure the water supply hose is not kinked or clogged.• Make sure there is sufficient water pressure.
After a cycle, detergent remains in the detergent drawer.	<ul style="list-style-type: none">• Make sure the washing machine is running with sufficient water pressure.• Make sure the detergent is added to the centre of the detergent drawer.• Make sure the rinse cap is inserted properly.• If using granular detergent, make sure the detergent selector is in the upper position.• Remove the rinse cap and clean the detergent drawer.



Problem	Action
Excessive vibrations or makes noise.	<ul style="list-style-type: none"> • Make sure the washing machine is installed on a level, solid floor that is not slippery. If the floor is not level, use the levelling feet to adjust the height of the washing machine. • Make sure the shipping bolts are removed. • Make sure the washing machine is not contacting any other object. • Make sure the laundry load is balanced. • The motor can cause noise during normal operation. • Overalls or metal-decorated clothes can cause noise while being washed. This is normal. • Metal objects such as coins can cause noise. After washing, remove these objects from the drum or filter case.
Does not drain and/or spin.	<ul style="list-style-type: none"> • Make sure the drain hose is straightened all the way to the drain system. If you encounter a drain restriction, call for service. • Make sure the debris filter is not clogged. • Close the door and press or tap START/PAUSE. For your safety, the washing machine will not tumble or spin unless the door is closed. • Make sure the drain hose is not frozen or clogged. • Make sure the drain hose is connected to a drain system that is not clogged. • If the washing machine is not supplied with sufficient power, the washing machine temporarily will not drain or spin. As soon as the washing machine regains sufficient power, it will operate normally.
The door does not open.	<ul style="list-style-type: none"> • Press or tap START/PAUSE to stop the washing machine. • It may take a few moments for the door lock mechanism to disengage. • The door will not open until 3 minutes after the washing machine has stopped or the power turned off. • Make sure all the water in the drum is drained. • The door may not open if water remains in the drum. Drain the drum and open the door manually. • Make sure the door lock light is off. The door lock light turns off after the washing machine has drained.



Troubleshooting

Problem	Action
Excessive suds.	<ul style="list-style-type: none"> • Make sure you use the recommended types of detergent as appropriate. • Use high efficiency (HE) detergent to prevent oversudsing. • Reduce the detergent amount for soft water, small loads, or lightly soiled loads. • Non-HE detergent is not recommended.
Cannot apply additional detergent.	<ul style="list-style-type: none"> • Make sure the remaining amount of detergent and fabric softener is not over the limit.
Stops.	<ul style="list-style-type: none"> • Plug the power cord into a live electrical outlet. • Check the fuse or reset the circuit breaker. • Close the door and press the START/PAUSE button to start the washing machine. For your safety, the washing machine will not tumble or spin unless the door is closed. • Before the washing machine starts to fill, it will make a series of clicking noises to check the door lock and does a quick drain. • There may be a pause or soak period in the cycle. Wait briefly and the washing machine may start. • Make sure the mesh filter of the water supply hose at the water taps is not clogged. Periodically clean the mesh filter. • If the washing machine is not supplied with sufficient power, the washing machine temporarily will not drain or spin. As soon as the washing machine regains sufficient power, it will operate normally.

Problem	Action
<p>Fills with the wrong water temperature.</p>	<ul style="list-style-type: none"> • Fully open both taps. • Make sure the temperature selection is correct. • Make sure the hoses are connected to the correct taps. Flush water lines. • Make sure the water heater is set to supply a minimum 49 °C hot water at the tap. Also, check the water heater capacity and recovery rate. • Disconnect the hoses and clean the mesh filter. The mesh filter may be clogged. • While the washing machine fills, the water temperature may change as the automatic temperature control feature checks incoming water temperature. This is normal. • While the washing machine fills, you may notice just hot and/or just cold water going through the dispenser when cold or warm temperatures are selected. This is a normal function of the automatic temperature control feature as the washing machine determines the water temperature.
<p>Load is wet at the end of a cycle.</p>	<ul style="list-style-type: none"> • Use the High or Extra High spin speed. • Use high efficiency (HE) detergent to reduce oversudsing. • Load is too small. Small loads (one or two items) may become unbalanced and not spin completely. • Make sure the drain hose is not kinked or clogged.
<p>Leaks water.</p>	<ul style="list-style-type: none"> • Make sure the door is properly closed. • Make sure all hose connections are tight. • Make sure the end of the drain hose is correctly inserted and secured to the drain system. • Avoid overloading. • Use high efficiency (HE) detergent to prevent oversudsing.
<p>Has odours.</p>	<ul style="list-style-type: none"> • Excessive suds collect in recesses and can cause foul odours. • Run cleansing cycles to sanitize periodically. • Clean the door seal (diaphragm). • Dry the washing machine interior after a cycle has finished.
<p>No bubbles are seen (BubbleShot models only).</p>	<ul style="list-style-type: none"> • Overloading may screen bubbles. • Severely contaminated laundry may not generate bubbles.

Troubleshooting

Problem	Action
Can I open the Add Door at any time?	<ul style="list-style-type: none"> The Add Door can be opened only when the  indicator appears. However, it does not open in the following cases: <ul style="list-style-type: none"> When the boiling or drying process is running and the internal temperature becomes high If you set the Child Lock for safety reasons When the drum wash or drum drying cycle is running that does not involve additional laundry

If a problem persists, contact a local Samsung service centre.

Information codes

If the washing machine fails to operate, you may see an information code on the screen. Check the table below and try the suggestions.

Code	Action
1C	Check the water level sensor. <ul style="list-style-type: none"> Power off and power the machine on after 2-3 minutes, and then try again. Depending on the model, the drain system drains water automatically. The POWER and START/PAUSE buttons may be disabled during this process.
TC2	Check the temperature sensor on the dry air. <ul style="list-style-type: none"> Power off and power the machine on after 2-3 minutes, and then try again.
DC	The door is open. <ul style="list-style-type: none"> Close the door and press START/PAUSE to resume operation.
DC1	Check the door switch. <ul style="list-style-type: none"> Power off and power the machine on after 2-3 minutes, and then try again.
LC	Check for water leaks. <ul style="list-style-type: none"> Power the machine off and check the drain system for any leak. Once the leak is solved, power the machine on after 2-3 minutes. Depending on the model, the drain system drains water automatically. The POWER and START/PAUSE buttons may be disabled during this process.

Code	Action
FC	<p>Check the fan motor.</p> <ul style="list-style-type: none"> Power off and power the machine on after 2-3 minutes, and then try again.
4C	<p>Check the water supply line.</p> <ul style="list-style-type: none"> Check for the connection of the water line (including water taps). Power off and power the machine on after 2-3 minutes, and then try again. Depending on the model, the drain system drains water automatically. The POWER and START/PAUSE buttons may be disabled during this process.
4C2	<p>Laundry needs protection because the water being supplied is too hot.</p> <ul style="list-style-type: none"> Make sure the cold and hot water taps are properly connected. Power off and power the machine on after 2-3 minutes, and then try again.
5C	<p>Check the drain system.</p> <ul style="list-style-type: none"> Make sure the drain filter is not clogged. If the drain filter is clogged, clean the filter and restart the machine.
HC	<p>Check the washing heater.</p> <ul style="list-style-type: none"> Power off the machine and contact a local Samsung service centre.
HC2	<p>Check the drying heater.</p> <ul style="list-style-type: none"> Power off and power the machine on after 2-3 minutes, and then try again.
Ub	<p>Check the spinning process.</p> <ul style="list-style-type: none"> The load may not be balanced inside the drum. Check the drum and make sure the load is balanced. Press START/PAUSE to resume operation, or power off and power the machine on after 2-3 minutes, and then try again.
8C, 8C1, 8C2	<p>Check the MEMS sensor.</p> <ul style="list-style-type: none"> Power off and power the machine on after 2-3 minutes, and then try again.

Troubleshooting





























Code	Action
OC	Water may overflow. <ul style="list-style-type: none">• Close the water valve and call for service.
3C	Check the motor. <ul style="list-style-type: none">• Power off and power the machine on after 2-3 minutes, and then try again.
AC6	Check the PBA communication status. <ul style="list-style-type: none">• Power off and power the machine on after 2-3 minutes, and then try again.
DDC	The Add Door is open. <ul style="list-style-type: none">• Close the Add Door and press START/PAUSE to resume operation.
DC3	Check the Add Door. <ul style="list-style-type: none">• Power off and power the machine on after 2-3 minutes, and then try again
UC	Check the electronic control board. <ul style="list-style-type: none">• Check if power is supplied properly.• If the information code continues to appear, call for service. A low voltage is detected. <ul style="list-style-type: none">• Check if the power cord is plugged in properly.• If the information code continues to appear, call for service.

For more information, see the user manual. If any of the information codes continues to appear, contact a local Samsung service centre.

Specifications

Fabric care chart

The following symbols provide garment care directions. The care labels include four symbols in this order: washing, bleaching, drying and ironing (and dry cleaning when necessary). The use of symbols ensures consistency among garment manufacturers of domestic and imported items. Follow the care label directions to maximize garment life and reduce laundry problems.

	Resistant material		Do not iron
	Delicate fabric		Can be dry cleaned using any solvent
 	Item can be washed at 95 °C		Dry clean
 	Item can be washed at 60 °C		Dry clean with perchloride, lighter fuel, pure alcohol or R113 only
 	Item can be washed at 40 °C		Dry clean with aviation fuel, pure alcohol or R113 only
 	Item can be washed at 30 °C		Do not dry clean
	Hand wash only		Dry flat
	Dry clean only		Can be hung to dry
	Can be bleached in cold water		Dry on clothes hanger
	Do not bleach		Tumble dry, normal heat
	Can be ironed at 200 °C max		Tumble dry, reduced heat
	Can be ironed at 150 °C max		Do not tumble dry
	Can be ironed at 100 °C max		

Specifications

Protecting the environment

- This appliance is manufactured from recyclable materials. If you decide to dispose of this appliance, please observe local waste disposal regulations. Cut off the power cord so that the appliance cannot be connected to a power source. Remove the door so that animals and small children cannot get trapped inside the appliance.
- Do not exceed the detergent quantities recommended in the detergent manufacturer's instructions.
- Use stain removal products and bleaches before the wash cycle only when strictly necessary.
- Save water and electricity by only washing full loads (the exact amount depends upon the cycle used).

Specification sheet

“ * “ Asterisk(s) means variant model and can be varied (0-9) or (A-Z).

Type		Front loading washing machine	
Model name		WD13J7*****	
Dimensions		W686 x D811 x H990 (mm)	
Water pressure		50 kPa - 800 kPa	
Net weight		104.0 kg	
Wash and spin capacity		13.0 kg	
Dry capacity		7.0 kg	
Power consumption	Washing	220 - 240 V	250 - 300 W
	Washing and heating		2200 - 2400 W
	Drying		2100 - 2300 W
	Spin		600 W
	Pumping		30 W
Package weight		Paper	1.3 kg
		Plastic	1.8 kg
Spin revolutions		1100 rpm	

NOTE

The design and specifications are subject to change without notice for quality improvement purposes.

Memo

Memo

QUESTIONS OR COMMENTS?

COUNTRY	CALL	OR VISIT US ONLINE AT
AUSTRALIA	1300 362 603	www.samsung.com/au/support



DC68-03464M-00